

WALK-IN COLD ROOMS, A PRACTITIONER'S TECHNICAL GUIDE

Design and Operation of Walk-In Cold Rooms for Precooling and Storage of Fresh Produce in Hot Climates, in Off-Grid and Unreliable Grid Situations



DECEMBER 2023



INSTITUT INTERNATIONAL DU FROID
INTERNATIONAL INSTITUTE OF REFRIGERATION

 **EFFICIENCY
FOR ACCESS**

Disclaimer/Copyright



The information provided in this document is based on the current state of the art and is designed to assist engineers, scientists, companies and other organizations.

This is a preliminary source of information that must be completed before any application or detailed project. Although every possible care has been taken in the production of this document, Energy Sector Management Assistance Program, Efficiency for Access and the International Institut of Refrigeration, their employees, officers and consultants cannot accept any responsibility for the accuracy or correctness of the information provided nor for the consequences of its use or misuse.

For full or partial reproduction of anything published in this document, proper acknowledgement should be made to the original source and its author(s). No parts of the book may be commercially reproduced, recorded and stored in a retrieval system or transmitted in any form or by any means (mechanical, electrostatic, magnetic, optic photographic, multimedia, Internet-based or otherwise) without permission written by ESMAP, Efficiency for Access and the IIR.



To quote this guide, please use the following citation text:

Efficiency for Access, International Institute of Refrigeration. Walk-In Cold Rooms: A Practitioner's Technical Guide. Available on <https://efficiencyforaccess.org/publications/walk-in-cold-rooms-a-practitioners-technical-guide> and <https://iifir.org/en/fridoc/walk-in-cold-rooms-a-practitioner-s-technical-guide-design-and-148065>

Copyright © 2023 Energy Sector Management Assistance Program (ESMAP), Efficiency for Access and the International Institute of Refrigeration (IIR). All rights reserved.

© Photos Covers and Chapters: Coldhubs - CoolCrop, VCCA Coldtivate - Ecofrost - Giertsen, Selfchill - Hohenheim Strathmore - Inficold - Smart Villages Research Group - Solarcool - W.Giertsen Energy Solutions - Shutterstock
Graphic Design: Studio 201 - 12/23

Main contributors

ESMAP is a partnership between the World Bank and 24 partners to help low and middle-income countries reduce poverty and boost growth through sustainable energy solutions. ESMAP's analytical and advisory services are fully integrated within the World Bank's country financing and policy dialogue in the energy sector. Through the World Bank Group (WBG), ESMAP works to accelerate the energy transition required to achieve Sustainable Development Goal 7 (SDG7) to ensure access to affordable, reliable, sustainable and modern energy for all. It helps to shape WBG strategies and programs to achieve the WBG Climate Change Action Plan targets.

The **ESMAP Efficient Clean Cooling Program** aims to leverage the World Bank Group's balance sheet to mainstream and integrate efficient and clean cooling in relevant World Bank policy dialogues and lending operations (IBRD and IDA), thus accelerating the adoption and deployment of sustainable, climate-friendly, and reliable cooling solutions. The program works to strengthen the enabling environment, develop the necessary market infrastructure, and design and operate financing mechanisms and business models. It works across multiple sectors such as health, agriculture (horticulture, dairy, fisheries), buildings, and urban spaces in Lower and Middle Income countries, mainly focusing on space cooling (energy-efficient buildings and air conditioning), refrigeration, and cold chains, and the mitigation of urban heat island effects.

Efficiency for Access: Efficiency for Access is a global coalition working to promote affordable, high-performing, and inclusive appliances that enable access to clean energy for the world's poorest people. It is a catalyst for change, accelerating the growth of off and weak-grid appliance markets to boost incomes, reduce carbon emissions, improve quality of life, and support sustainable development. <https://efficiencyforaccess.org>

International Institute of Refrigeration (IIR): The IIR is an independent intergovernmental organisation. It is the only one in the world to gather scientific and technical knowledge in every sector of refrigeration. The IIR is committed to disseminating knowledge of refrigeration to improve the quality of life for all, while respecting the environment and taking into account economic imperatives. <https://iifiir.org/en>

Acknowledgements

This Guide was produced through the knowledge, experience, and hard work of a diverse community of experts. Working together on this Guide, they have explained postharvest care of perishable produce, cooling technologies, renewable energy sources as well as planning, set up and management of businesses based around a walk-in cold room in countries of the Global South. The International Institute of Refrigeration team, which initiated and managed the task, extends heartfelt thanks to everyone who contributed to this task.

To produce this guide, the IIR worked in partnership with the Efficiency for Access coalition, the Postharvest Education Foundation, the SELCO Foundation, Wageningen University & Research and ESMAP Efficient Clean Cooling Program. Funding from ESMAP Efficient Clean Cooling Program and the Efficiency for Access coalition helped make the work possible.

The IIR is grateful for the conceptual and preparatory work by Leo Blyth, Giovanni Cortella, Didier Coulomb, Judith Evans, Jeremy Tait and others. The main authors were Kilian Blumenthal, Judith Evans, Lisa Kitinoja, Steve McCarney, Karthika Sasidharan, Jan Verschoor and Jakub Vrba. The Guide was edited by Giovanni Cortella (University of Udine) and Jeremy Tait (Tait Consulting).

The IIR editorial team also thanks each of the experts listed below and all others who contributed for their input, reviews, and commitment in many ways to make this Guide as useful as it possibly can be. We look forward to growing this community of experts and building on the collective knowledge in coming years.

Further development and promotion of this knowledge:

Because this field is new and evolving quickly to address many extreme challenges, we invite all readers to help develop the knowledge reflected in this guide. The organisations behind the guide would welcome suggestions of how this knowledge can be applied and promoted.

Its content may be reproduced in line with the copyright restrictions on page 2 using the suggested citation text.





Nya Abagi	Efficiency for Access (CLASP)
Monique Baha	International Institute of Refrigeration
Chris Beland	Efficiency for Access (Energy Saving Trust)
Kilian Blumenthal	GIZ WE4F
Leo Blyth	ESMAP Efficient Clean Cooling Program
Thomas Bundi	Strathmore University
Nirmita Chandrashekar	SELCO Foundation
Eva Lee Chih-Jung	GIZ Benin
Giovanni Cortella	University of Udine
Philipp Denzinger	GIZ Proklima
Ravindra Dolare	Ecozen
Jean-Luc Dupont	International Institute of Refrigeration
Aur�lie Durand	International Institute of Refrigeration
Chris Emmott	Acumen
Judith Evans	London South Bank University
Nitin Goel	Inficold India Private Limited
Ellie Grebenik	Efficiency for Access (Energy Saving Trust)
Nathalie de Grissac	International Institute of Refrigeration
Harish Hande	SELCO Foundation
Bas Hetterscheid	Wageningen University & Research
Deirdre Holcroft	The Postharvest Education Foundation
Pat Hughes	Patrick Hughes Ltd
Makena Ileri	Efficiency for Access (CLASP)
Huda Jaffer	SELCO Foundation
Bernie Jones	Smart Villages Research Group
Dimitris Karamitsos	The Basel Agency for Sustainable Energy (BASE)
Laurie Kent	Smart Villages Research Group
Lisa Kitinoja,	The Postharvest Education Foundation
Julian Krueger	W. Giertsen Energy Solutions
Elisa Lai	CLASP - Verasol
Pramod Majety	Ecozen
Niraj Marathe	CoolCrop
Steve McCarney	ESMAP Efficient Clean Cooling Program, and Sunny Day LLC
Sonja Mettenleiter	Solar Cooling Engineering
Charlie Miller	Efficiency for Access (Energy Saving Trust)
Julian Mitchell	InspiraFarms Cooling
Maryvelma Nafula	UNESCO Chair for Climate Change Resilience and Sustainability Strathmore University
Olubukola Odeyemi	The Postharvest Education Foundation
Theerada Reinhardt	Fosera
Karthika Sasidharan	Global SDG7 Hubs
Jeremy Tait	Tait Consulting
Vijay Yadav Tokala	The Postharvest Education Foundation
Victor Torres Toledo	Solar Cooling Engineering
Zafer Ure	Phase Change Material Products Limited
Jan Verschoor	Wageningen University & Research
Jakub Vrba	Efficiency for Access (Energy Saving Trust)
Bing Xu	Heriot-Watt University

Table of Contents

1. INTRODUCTION	14
1.1 The purpose of this guide	15
1.2 Scope of the guide	15
1.3 WICR as an element of cold chains for communities	17
1.4 A WICR is not the solution for every business, nor for every foodstuff storage challenge	17
1.5 Overview of the guide	18
2. FRESH PRODUCE STORAGE CONSIDERATIONS	19
2.1 Introduction	20
2.2 Fresh produce basics: what makes it special?	21
2.2.1 Effect of storage temperature on fruit quality	21
2.2.2 How respiration rate affects fresh produce quality	21
2.2.3 How water loss affects fresh produce quality	22
2.2.4 How ethylene affects fresh produce quality	23
2.2.5 Mechanical injury: Effects of product handling on quality	24
2.2.6 Chilling injury	24
2.2.7 How do harvest timing and handling affect the fresh produce quality?	25
2.3 Fresh produce quality management: advice for the design and operation of cold stores	25
2.3.1 Temperature management	26
2.3.2 The need for precooling and options to achieve it	30
2.3.3 Relative humidity management	31
2.3.4 Management of fresh air exchange	33
2.3.5 Ethylene control in the WICR	33
2.3.6 Compatibility of produce types in storage and three typical storage environments	33
2.3.7 Airflow and the importance of racking, container types, and packaging materials	34
2.3.8 Design for seasonal variation of usage	34
2.3.9 Cold storage for other fresh foods	35
2.4 References	36

3. PLANNING A COLD ROOM 38

3.1	A roadmap through the process of planning a walk-in cold room	39
3.2	Is an electric powered walk-in cold room the right solution for this situation?	42
3.3	Summary of cooling tasks and maximum electrical power	43
3.4	Type and size of cold room	44
3.4.1	Pre-assembled cold rooms	44
3.4.2	Prefabricated ('flat packed') cold room kits	45
3.4.3	Refrigerated ISO containers (reefers) and similar	46
3.4.4	Self-built cold rooms	46
3.4.5	Shipping container cold rooms	47
3.4.6	Size of the cold room	48
3.5	Site for the cold room	48
3.6	Power supply type	48
3.6.1	Power availability, quality and reliability. PV systems, backup generators	48
3.6.2	Phasing of cooling demand with power availability – Energy storage	51
3.7	Business models	51
3.7.1	Introduction	51
3.7.2	Prerequisites for a sustainable walk-in cold room business	53
3.7.3	Overview of the main walk-in cold room business models	54
3.7.4	The role of service-based models in walk-in cold room development and operations	57
3.7.5	Six main business models with examples	59
3.8	Financing	64
3.8.1	Overview of the main walk-in cold room financing options	64
3.8.2	Summary of the main financing types for walk-in cold rooms	65
3.9	Outline technical specification	67
3.10	The Go/No-go decision	71
3.11	Detailed specification and design	72
3.12	Procurement	72
3.13	Installation and commissioning	73
3.14	Operation and management	74
3.15	References	76

4. DESIGN OF THE COLD ROOM 77

4.1	Introduction to the design of a cold room	78
4.2	Basics about refrigeration	79
4.2.1	Types of vapour compression system and how they work	79
4.3	Overall design priorities for the cold room	82
4.3.1	Design priorities and achieving good energy efficiency	82
4.3.2	Design for reliability and ease of maintenance	84
4.3.3	Design for reconfiguration	84
4.3.4	Design for precooling of produce	85
4.3.5	Design for flexibility and seasonality of loading	87
4.3.6	Design to minimise environmental impact	88
4.4	Heat load assessment	88
4.5	Sizing of cooling plant	93
4.6	Considerations for design of the insulated structure	94
4.6.1	Design of the insulated envelope	94
4.6.2	Vapour seal of the insulated envelope	96
4.6.3	Minimising heat loss through the door(s)	97
4.6.4	Protect insulated panels from impact damage	98
4.6.5	Design to minimise solar heat gain	98
4.6.6	Considerations for self-built cold rooms	98
4.7	Estimating the electrical power requirements of the whole system delete	99
4.8	Refrigerant selection	101
4.8.1	Synthetic Refrigerants Containing Fluorine	101
4.8.2	Natural Refrigerants	102
4.9	Considerations for ancillary systems	104
4.9.1	Defrosting	104
4.9.2	Lighting	105
4.9.3	Pipework	105
4.9.4	Pressure relief for the cooled space	106
4.9.5	Ventilation	106
4.9.6	Control of ethylene gas levels	107

4.10	Monitoring systems for performance of store, cooling plant and the business	107
4.10.1	Overview of the approach to monitoring	107
4.10.2	Technical monitoring of the refrigeration plant and its performance	108
4.10.3	Metric for efficiency of the refrigeration system	109
4.10.4	Technical parameters to be monitored	110
4.10.5	Data capture strategy and data loggers	112
4.11	Considerations for siting of equipment (cold room layout)	114
4.11.1	Layout for ease of loading: access paths, racking and lighting	114
4.11.2	Design for good airflow (circulation of air)	115
4.11.3	Placement of evaporators	115
4.11.4	Placement of thermal energy storage systems in the cold room	116
4.11.5	Placement of condensers	117
4.11.6	Positioning monitoring equipment and sensors	117
4.12	Design for safety of staff and cold room	118
4.12.1	General safety of personnel	118
4.12.2	Door safety	119
4.12.3	Suffocation risks (asphyxiation)	119
4.12.4	Fire risks	119
4.12.5	Safety of refrigerants	120
4.13	References	120
4.14	Appendix 1: Detailed estimation of the heat load	121
4.14.1	Nomenclature	121
4.14.2	Total heat load	123
4.14.3	Heat through the insulation (transmission)	123
4.14.4	Solar gain (radiation)	124
4.14.5	Heat from air infiltration	125
4.14.6	Heat load from staff working in the store	126
4.14.7	Product load including precooling	127
4.14.8	Heat from respiration	129
4.14.9	Heat from fans	129
4.14.10	Heat from defrost	129
4.14.11	Heat from lights	130
4.14.12	Heat from other electrical loads	130
4.14.13	Heat from other machinery used in the store	130
4.15	References for the Appendix	130

5. ENERGY SUPPLY AND STORAGE SYSTEMS	131
5.1 Introduction to Part 5	132
5.2 Options for energy supply and energy management	132
5.2.1 Four types of electricity supply and their quality	132
5.2.2 Benefits of energy storage	134
5.2.3 Electrical loads	135
5.2.4 Electricity supply selection	136
5.2.5 Site Electrical Requirements Worksheet	144
5.2.6 Overview of energy storage (electrical and thermal)	145
5.3 Solar energy applications	146
5.3.1 Types of PV systems used for cooling	147
5.3.2 PV system components	147
5.3.3 PV electricity system configurations	148
5.4 Solar power system components and design	152
5.4.1 PV modules	152
5.4.2 PV array mounting structures	157
5.4.3 Batteries	161
5.4.4 Inverters	167
5.5 Thermal energy storage (TES) options	169
5.5.1 Current trends in TES	169
5.5.2 Thermal Energy Storage compared with electrical energy storage	171
5.5.3 Example sizing a system with TES	171
5.6 PV system safety	174
5.6.1 Electrical hazards	174
5.6.2 Physical hazards	174
5.6.3 Chemical hazards	175
5.6.4 Hazard avoidance	175
5.7 References	176

6. INSTALLATION AND COMMISSIONING 177

6.1	Planning for installation	178
6.1.1	Considerations for import and shipping of equipment to the country	178
6.1.2	Transportation to site	180
6.1.3	Site location and floor preparation	181
6.1.4	Points to discuss with the installation team	182
6.1.5	Assembly of the cold room	184
6.1.6	Installation of the power system	185
6.1.7	Cleaning and ventilating the new cold room	190
6.2	Commissioning of the cold store	190
6.2.1	Structural checks	192
6.2.2	Electrical Commissioning	193
6.2.3	Thermal commissioning	194
6.2.4	Refrigeration system commissioning	196
6.2.5	Other system checks	197
6.2.6	Before signing off commissioning and handing over the plant	197

7. OPERATION AND MANAGEMENT OF WALK-IN COLD ROOMS	200
7.1 Introduction to cold room operation	201
7.2 Overview of an operational protocol for cold room management	201
7.3 Keep the cold room clean and tidy	202
7.4 Planning temperatures for the storage of produce	203
7.5 Other considerations for co-storage of produce – ethylene and odours	204
7.6 Optimising utilisation through the year	204
7.7 Managing receipt and loading of produce	205
7.7.1 Limit produce temperature before storage	205
7.7.2 Registration of incoming produce	205
7.7.3 Grade and sort produce before storage	206
7.7.4 Precooling of produce	206
7.7.5 Careful loading and stacking of produce in the cold room – avoiding over-load	206
7.8 Monitoring for operational performance	208
7.9 Inventory management	210
7.9.1 Inventory management using manual systems	210
7.9.2 Inventory management using app-based platforms; and digital twins	210
7.10 Maintenance of the cold room	211
7.10.1 A generic maintenance checklist: weekly	211
7.10.2 A generic maintenance checklist: three or six monthly	212
7.10.3 Calibration of temperature sensors	213
7.11 Operational budgeting for the cold room	213
7.11.1 OPEX budget for running the cold room	213
7.11.2 Budget for maintenance and spare parts	214
7.12 References	214

8. BIBLIOGRAPHY AND REFERENCES; RESOURCES FOR FURTHER GUIDANCE **215**

8.1	Introductory material on walk-in cold rooms and cold chains	216
8.2	Post-harvest storage of produce and food science	217
8.3	Refrigeration hardware and design and installation advice	217
8.4	Solar photovoltaic and electrical systems	218
8.5	Business planning and financing	219
8.6	International technical standards, quality frameworks and product testing	219
8.7	Sourcing of hardware	220
8.8	Passive cooling approaches (zero or low energy)	220
8.9	Further resource lists for post-harvest and cooling technologies	220

ANNEXES **221**

	Terminology used in this guide	222
	Glossary	223
	Acronyms, abbreviations	227



1.

Introduction

1.1 The purpose of this guide

The number of manufacturers of small cold rooms for rural farming and food use is increasing from a low base. However, the learning curve for newcomers remains steep and even well-established suppliers are learning more every day. There are extreme challenges for cold rooms when operating in locations remote from reliable power, away from supply chains, hard to reach for technical support and with a hot climate. This guide consolidates the current state of the art on designing and operating walk-in cold rooms that are well suited for this type of market. Drawing on the practical experience of leading experts and suppliers across Africa, India and elsewhere, it will help suppliers and users to achieve the best solutions for each application and avoid common mistakes.

The purpose of the guide is summarised as:

To present accessible, practical guidance that enables developers, owners, operators and suppliers to specify, install and operate effective and appropriate precoolers and cold rooms that are as economically viable as possible in off-grid, unreliable and limited power supply situations.

The guide assists the project manager through the process of procuring a cold room, enabling them to have effective discussions with specialists and suppliers, through to operating the cold room effectively. The project manager will be armed with information to be able to ask informed questions and give suppliers the information needed for good design decisions. The guide will also help suppliers to improve their system designs.

1.2 Scope of the guide

This guide covers commercially available types of small walk-in cold rooms designed to precool and store fresh horticultural and agricultural produce near farms or at rural aggregation centres, communities or markets, using temperature, humidity, and gas-controlled conditions for maintaining quality of produce. An important consideration of the guide is how to ensure effective cooling in situations of limited, unreliable power supply and off-grid where no grid power is available at all, focusing on distributed renewable energy sources and energy storage. Priority is given to environmental sustainability through good energy efficiency and choice of components and refrigerants with lower associated global warming impact.

We define a cold room as:

A cooled and insulated structure designed to maintain an artificially generated low temperature, sometimes with control of humidity; it can be free standing outdoors or located within another structure. A 'walk-in cold room' (WICR) has at least one door that is large enough for a person to walk through into the cold room.

Looking in turn at aspects of the scope, this guide focuses on:

- *Products to be stored:* horticultural and agricultural produce; *not* bulk milk cooling, ice production, cooling for meat and fish value chains, refrigerated transportation, healthcare nor storage of vaccines.
- *Storage temperature:* the guide addresses chilled storage only (0°C and above); *not* frozen storage.

- *Size of cold room:* mainly up to around 80 cubic metres (equivalent to a standard 40ft shipping container), but most advice is also relevant for cold rooms at least twice that size, or more.
- *Types of cold room solutions:* site-built and 'containerised' solutions, standalone structures and those within another building.
- *Types of refrigeration plant:* mainstream electrically driven vapour compression technologies and conventional insulated sandwich-panel construction, because these follow established good practice for reliability, accessibility and ongoing maintenance. This covers equipment and skills that are more likely to be accessible regionally (access may still, however, be very limited in remote regions). Many other technologies and cold chain solutions are available but fall outside the scope of this guide. 'Passive assist' solutions such as shading and evaporative cooling are noted as low-cost ways to achieve precooling of warm produce from the field, but are not covered in any detail. Affordability is a priority, acknowledging that these technologies are expensive for these markets and will require innovative financing and business models for most applications. Further reading is signposted for the main alternative and complementary solutions.
- *Types of power supply:* reliable grid supply, limited grid supply, unreliable grid supply and off-grid supply. Particular focus is on solar photovoltaic energy sources and design of hybrid solutions.
- *Operational point in the value chain:* primarily first mile and rural markets; also useful for small-scale storage at most stages of the supply chain. *Not* cooling for direct sale to customers, e.g. in retail display cabinets; however, retailers may use a small cold room, of the type the guide covers, in back-of-store or to serve food markets.
- *Mobility:* cold rooms designed primarily for stationary use, though consideration of a design that is possible to reposition to suit evolving needs or change of land use is suggested. *Not* refrigerated transport.
- *New versus refurbishment:* the main aim is to establish a new facility, but much of the advice could also be applied to refurbishment projects.

Examples types of walk-in cold room considered within scope are shown in Figure 1.1.



Figure 1.1

Examples of some types of walk-in cold room considered within scope of this guide, showing solar photovoltaic powered units and grid connected units (*Sources: Coldhubs; Ecozen; Giertsen; SELCO Foundation; Solar Cooling Engineering*).

1.3 WICR as an element of cold chains for communities

Walk-in cold rooms are best employed as part of a so-called 'cold chain' that includes several links from farm post-harvest to the home of the final customer with a view to improving or sustaining the quality and nutritional value of the produce and reducing food loss and waste. Each of these links needs equipment with different specifications and design solutions. Through decentralised sustainable solutions, cold chains are continuing to develop as increasing numbers of cold rooms become affordable and accessible to marginalised and vulnerable communities. In addition to helping preserve food safety, quality, nutrition and value, which all contribute to income generation, cold storage can raise standards of living and improve social well-being. Many farmers who may have left the occupation or found work as daily wage laborers can be encouraged back to cultivate, produce and build a business by taking advantage of cold storage to reduce losses, maintain quality and secure better prices. The farmers can be empowered and trained to take advantage of technology and market innovations to make their process more efficient, faster and reliable. Maintaining the quality and saving produce from spoilage helps in building security for the individual and the community, creating a safety net for the poor to better withstand weather and economic events.

Walk-in cold rooms are needed in large numbers in emerging economies and are one element within a larger web of local and regional cold chain facilities and equipment. For the 'field to plate' journey of any perishable foodstuff, when any single link in the cold chain is broken, the product quality, value, and shelf life will suffer. But working together, this equipment increases availability of high nutrition foods, improves food security and supports sustainable local agricultural economies.

1.4 A WICR is not the solution for every business, nor for every foodstuff storage challenge

Cooling perishables after harvest is the best way to preserve their quality, but cooling is only feasible if the relatively high investments and costs can be earned back. Cooling in agriculture is not a goal in itself and is just one of several means to maintain produce quality/marketability; other approaches must also be considered as competing solutions. If the aim is to improve food and nutrition security through accessibility, it is often cheaper to extend the production season, implement irrigation, process food (e.g., by drying) or improve market connectivity, rather than using cooling. This is one of the reasons that the business case for setting up agricultural cold chains is challenging for domestic markets in low and lower-middle income countries. A methodology to assess what interventions are feasible in postharvest chains to achieve specific goals (e.g., food and nutrition security, export development) can greatly help to identify whether cooling is a viable option. An example of such a methodology is the Postharvest Assessment Methodology by Wageningen University¹.

Three further crucial aspects of deciding the suitability of a cold room are: firstly, that the business plan must fully consider the cold room as part of an entire value chain in order to be economically viable. Secondly, experience shows that cold storage without capacity to pre-cool produce before it is stored falls quickly into disuse as it cannot cope with the heat load. Thirdly, to ensure that suitably trained and equipped people will be available to maintain and repair the cold room once it is in operation.

¹ *Postharvest Assessment Methodology: a conceptual framework for a methodology to assess food systems and value chains in the postharvest handling of perishables as a basis for effective interventions.* Available from: <https://doi.org/10.18174/582556>.

This guide helps ensure economic and environmental sustainability for the longer term. The walk-in cold rooms addressed here will often be the start of introducing cooling in specific chains where money invested to achieve improved quality can be earned back. In practice to date, successful implementation of this type of cold room in low and middle-lower income countries is mostly seen for crop-specific processing and storage facilities (e.g. potatoes), or for high value export markets such as flowers or herbs. But as the technology solutions become better established and accessible, there is enormous scope for innovative and effective usage.

1.5 Overview of the guide

The guide is structured as follows:

- **Part 2:** 'Fresh food storage considerations' introduces the science behind preservation of fruit and vegetables. It helps decide the specification of conditions in the cold room and how to optimise its design and operation from a food quality point of view. This part introduces the crucial concept of precooling produce before it is placed in storage.
- **Part 3:** 'Planning a cold room' provides an overview of the process of specifying, procuring, designing, installing, commissioning and operating a cold room. It refers to all other parts of the guide for the necessary detail.
- **Part 4:** 'Design of the cold room' covers the technical detail and design considerations for each main sub-system including the insulated envelope, refrigeration plant, monitoring and layout/siting of equipment. A key aspect is estimating the heat load that the refrigeration plant will have to cope with, and the power requirement.
- **Part 5:** 'Energy supply and storage systems' explains how to assess the quality and availability of the power supply at the proposed site and the options to deliver the power as determined in 'Design of the cold room'. The focus for off-grid and unreliable power situations is solar photovoltaic systems. The roles of electrical battery and thermal storage are explained with considerations to optimise for each situation.
- **Part 6:** 'Installation and commissioning' helps to ensure that this stage of procurement runs smoothly through explaining priorities and checklists to be discussed with contractors.
- **Part 7:** 'Operation and management' provides a framework for an operational protocol and tips for managing aspects such as registration and processing of deliveries, and considerations for which produce can be stored in the same vicinity for best conditions and to avoid cross-contamination.
- **Part 8:** The 'Resources list' includes selected references to consult for the next level of detail on most aspects considered in the guide.



2.

Fresh produce storage considerations

2.

Fresh produce storage considerations

2.1 Introduction

This chapter explains the important physiological processes occurring in harvested fresh horticultural produce and how they affect postharvest quality. Different factors affecting the physiological activities and the ways to mitigate the losses by managing temperature, humidity and other storage conditions are discussed.

Section 2.2 explains the factors impacting the quality of the fruit and vegetables to help the cold room managers understand how the produce and storage conditions interact. The following factors must be considered when choosing storage conditions to suit each type or a mix of produce to reduce losses and maintain quality:

- Fresh produce basics
- Temperature
- Respiration
- Water loss
- Ethylene
- Mechanical injury
- Chilling injury
- Harvest timing and handling

Section 2.3 sets out how cold storage should be managed, the possible compromises that can be made for operating a viable business, and how a walk-in cold room (WICR) can be designed considering all these factors. Topics covered here are:

- Fresh produce quality management
- Temperature management
- Management of relative humidity (RH)
- Management of fresh air exchange
- Compatibility of produce types in storage
- Importance of racking, container types, and packaging materials on airflow
- Design for seasonal variation of usage
- Cold storage for other fresh foods

2.2 Fresh produce basics: what makes it special?

Even after harvest, horticulture produce and fruit continue their physiological activities, viz. respiration, transpiration, and other enzyme reactions at much higher rates than grain crops. Rough postharvest handling, pests, diseases, and storage conditions increase the ripening-related physiological processes such as rates of respiration and ethylene generation (which stimulates fruit ripening) and lead to high postharvest losses (Tavallali and Moghadam, 2015).

The management of the storage environment, maintaining low temperatures and high relative humidity, is critical for increasing postharvest storage life and delaying fruit quality deterioration (Domínguez et al., 2016; Gross et al., 2016). Cold storage or low-temperature storage has been proven to be an effective way of increasing the storage life of horticulture crops (Kitinoja, 2013) by slowing senescence (ageing, quality deterioration) and decay. Cold storage can also slow water loss and wilting to sustain quality for other types of produce.

2.2.1 Effect of storage temperature on fruit quality

Temperature management is the most powerful tool in postharvest quality management. Most horticultural produce has a 'Q₁₀ temperature coefficient' of about 2, which indicates that the rate of degradation enzyme activity doubles for each 10°C rise in storage temperature. This means that the potential storage life of produce can be doubled with every 10°C reduction in storage temperature, within its storage temperature range (Kitinoja, 2013). Maintaining the optimum storage temperatures has the following advantages (Kitinoja and Kader, 2015; Keller et al., 2013; Gross et al., 2016):

- Minimised water loss and related weight loss
- Sustained fruit firmness and nutritional value
- Reduced pathogen growth and symptoms of decay
- Longer storage life

However, fruit should never be stored below its lowest storage temperature, to avoid any adverse effects on its quality.

2.2.2 How respiration rate affects fresh produce quality

After harvest, fresh plant products continue their physiological activities. To do this, they need energy which is generated by the respiration process: oxygen (O₂) is taken in and carbon dioxide (CO₂) is released, using simple carbohydrates (glucose) as fuel. The fuel cannot be replenished after harvest once the product is no longer attached to the parent plant. The faster the respiration, the faster the fuel is diminished, and the faster ripening and senescence proceed.

	Driving style	Duration of drive
	Economic	Maximized
	Racing	Short

	Respiration	Duration of storage
	Minimized	Long -up to year round
	Normal	Short -a few weeks

Figure 2.1

If you drive economically, you can drive a longer distance on a tank of fuel than if racing. Similarly, minimising the respiration rate of fresh produce allows it to be stored longer. Cooling is a powerful tool to reduce respiration and thus improve postharvest management.

By lowering the temperature, the respiration rate is reduced, and the available fuel is used up at a slower rate, maintaining quality for a longer period. Respiration rates also differ for different products. Typically, rates are related to the function of that plant tissue with high rates for fast-developing tissues like shoots (e.g., asparagus, bean sprouts) and low rates for underground tissues (e.g. potatoes, yams).

A by-product of respiration is heat which raises the produce temperature (if it is not simultaneously cooled) and this catalyses further increases in respiration and rate of quality loss. Therefore, the sooner the produce is cooled after harvest, the greater the positive impact on quality retention.

2.2.3 How water loss affects fresh produce quality

Fresh fruit and vegetables contain up to 80-95% water and loss of water causes plant cells to lose rigidity (Harker et al., 1997) with loss of crispness that is very obvious in carrots, for example. It causes softening, loss of juiciness and a reduction in nutritional quality, e.g., vitamin C loss in wilted leafy greens (Lee and Kader, 2000). Since lost water cannot be replenished, to prevent shrivelling, loss of texture and wilting, it is important to minimise water loss from the moment of harvest.

Importantly for businesses, loss of water results in direct loss of saleable weight and revenue, as well as the quality impacts that could further reduce the price paid.

But the point at which water loss critically affects quality varies by type of produce: leafy vegetables wilt after about 3-5% water loss; green beans and nectarines shrivel after about 15-19% water loss. The rate of water loss is affected by the nature of the fresh produce as well as the environment around it (Becker and Fricke, 1996). Produce characteristics affecting water loss (the 'transpiration factors') include skin thickness, waxiness, and surface area to volume ratio (Sastry et al., 1978). Temperature and relative humidity (RH) critically affect water loss and combine to determine the water vapour pressure (VP), which can be looked up in psychrometric charts or tables. The relation between temperature and VP is shown in Figure 2.2. The driving force for water loss is the vapour pressure difference (VPD) between the vapour pressure of the environment and that of air at the surface of the produce (assumed as RH of 100%, i.e., water activity = 1). The VPD between the produce and the environment increases as temperature increases, or as environment RH decreases (Table 2.1). If VPD doubles, water loss will double too.

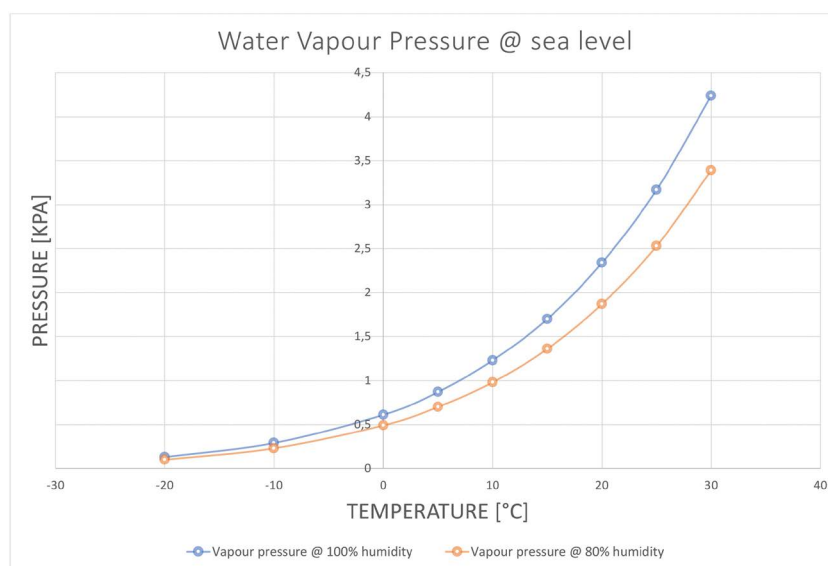

Figure 2.2

Relationship of temperature and water vapour pressure (VP) at 100% and 80% RH. Based on Mollier diagram values.

Table 2.1

The effect of temperature and relative humidity on vapour pressure (VP; Pa) and vapour pressure difference between 100% RH (to simulate produce) and 95% or 75% RH (to simulate storage atmospheres).

Temp °C	Product (100% RH)	Air at 95% RH		Air at 75% RH	
	VP Pa	VP Pa	VPD Pa	VP Pa	VPD Pa
0	611	581	30	458	153
10	1228	1167	61	921	307
20	2339	2222	117	1754	585
30	4246	4034	212	3185	1062

An example for storage of an apple:

- With a pulp temperature of 20°C (VP= 2339 Pa) and kept in air at 20°C and RH of 75% (VP = 1754 Pa) then the VPD is 585 Pa.
- If the RH is increased to 95% (VP= 2222 Pa) then the VPD is only 117 Pa.
- If the apple is cooled to 0°C (VP= 611 Pa) and held at 0°C and 75% RH (VP=458 Pa) then the VPD is 153 Pa.
- Finally, if the apple is held at optimum storage conditions (0°C and 95% RH) then the VPD is only 30 Pa.
- Conclusion: optimum storage conditions slow the rate of water loss for apples by a factor of nearly 20 (= 585 / 30) compared with 20°C and RH 75%.

If leafy vegetables were held under the same conditions as the apple, they would lose more water in each case, because of their higher surface area.

The air velocity close to products also plays a major role in rate of water loss. At low air speeds (as at the centre of a crate) a boundary layer of humid air will surround the stored products and limit water loss. High air speeds, such as products directly exposed to the throw of evaporator fans increases local water loss even if humidity is high. High air speed is good for cooling products faster but also increases water loss and so a compromise must be found that varies by situation. The recommended airflow rate is 0.0104 to 0.0208 m³/s/1000 kg for steady-state storage, and about 0.052 m³/s/1000 kg for precooling.

2.2.4 How ethylene affects fresh produce quality

Fruits and vegetables can be broadly divided into two physiological categories based on their metabolism during the ripening process: climacteric and non-climacteric.

Climacteric produce

Climacteric produce, such as apple, banana, pear, mango, tomato, passion fruit, cantaloupe, ripe kiwifruit, papaya, sapote and avocado, show a characteristic rise in respiration and generate ethylene during ripening. More information on ethylene production for several commodities can be found in the "Produce Fact Sheets" published by the Postharvest Center at University of California¹.

¹ <http://postharvest.ucdavis.edu/>

Ethylene accelerates the ripening and ageing process in produce exposed to it, such as when being stored closed by to ethylene producers. Climacteric fruits can be harvested before being completely ripe and subsequently “physiologically matured” – they will continue to ripen and improve in flavours postharvest. Commercially, climacteric fruits like mango, bananas and avocados are harvested at the ‘mature green’ (MG) stage, which is the physiological stage immediately before ripening begins. Sometimes the ripening process is triggered artificially by exposing these products to external ethylene. Such an ethylene treatment, which induces uniform ripening with consistent appearance and quality is used to ripen these fruits to the ready-to-eat stage (Mahajan et al., 2010; Blakey et al., 2012). However, ethylene induces softening and the breakdown of chlorophyll and so loss of green colour and yellowing. Banana, kiwifruit, and green pepper are especially sensitive to ethylene. Vegetable crops, such as leafy greens, carrot, potato, green bean, eggplant, pepper, sweet potato and yam, can suffer from yellowing, develop bitterness or experience more rapid senescence when exposed to ethylene.

Non-climacteric produce

In non-climacteric produce, such as grape, strawberry and orange, the rates of respiration gradually reduce during the ripening process, with no significant respiration peaks (Biale and Young, 1981). Non-climacteric fruits and vegetables do not produce ripening-related ethylene but can be sensitive to it. The ripening changes in non-climacteric fruit are not significant after the harvest and should therefore only be harvested when they are ripe enough to reach commercial quality.

Except for the ripening treatment described above, ethylene is mostly regarded as a risk factor while storing fresh products.

2.2.5 Mechanical injury: Effects of product handling on quality

Whilst low temperature and high relative humidity help extend storage life and maintain quality of fresh produce, mechanical damage can ruin a load. Mechanical damage includes impact bruising, scuffing, and cuts, which reduce the visual appearance quality and market value. Damage can occur due to rough handling, dropping or throwing produce into boxes; tipping boxes onto a hard surface during sorting; overfilling and improper packing during transportation. Damaged produce exhibits increased rates of respiration and ethylene production as a wound response. They become more susceptible to quality loss and microbial infections, have a shorter life and higher levels of postharvest loss and waste. Often, the effects of mechanical damage are only visible after storage, so training is needed on careful handling to prevent high food losses later in the postharvest chain: minimise product handling and transfers between containers; use cushioning material in crates and baskets; avoid overfilling, dropping or throwing produce; do not stand or walk on harvested produce.

2.2.6 Chilling injury

Horticultural crops can also be categorised by their storage temperature needs, which are often related to their geographical origins.

Temperate crops such as apples or berries are often stored long-term at nearly freezing temperatures (0 to 4°C), while sub-tropical crops such as citrus fruits, cucumber, eggplant and chilli can be safely stored for shorter periods at temperatures of 5 to 10°C. Tropical crops must be protected from cold temperatures and are usually stored at 13 to 15°C (avocado, banana, mango, papaya) or 18 to 21°C (sweet potato, mature green tomato, watermelon, yam).

Sub-tropical or tropical fruit are sensitive to too low temperatures and develop symptoms of chilling injury disorder. Symptoms often show after returning to ambient temperatures and include browning, surface pitting or uneven ripening (Figure 2.3).



Figure 2.3

Severe chilling injury symptoms in bananas when stored at temperatures less than 4°C for a week. (Image source: Vijay Yadav Tokala)

Storing at the lowest storage temperature helps to maximise postharvest life. For many products, optimal storage conditions can be found in the “Produce Fact Sheets” published by the Postharvest Center at University of California. Each crop has a natural storage potential or “shelf life” and will noticeably deteriorate as that time approaches, regardless of the storage environment.

2.2.7 How do harvest timing and handling affect the fresh produce quality?

Cold storage is only a part of the postharvest cold chain and for cold storage to be successful and profitable, the whole chain has to be considered. The timing of harvest and its procedures are crucial. Products should be harvested at the optimum maturity stage, which can be different depending on the target market. For example, climacteric produce (see Subsection 2.2.4) should be harvested taking market destination into account, i.e. red ripe for short chains or mature green for long chains. Non-climacteric produce like sweet oranges or strawberries should be harvested only when they attain commercial maturity as these do not undergo any ripening or improvement of flavour postharvest. More information on harvest maturity can be found for many products in the “Produce Fact Sheets” published by the Postharvest Center at University of California².

A key postharvest priority is cooling down as soon as possible to give the best quality retention, with practical measures such as shading essential if cooling is not immediately available. Also harvesting early in the morning before it gets too hot enables the produce to enter the cold room at a lower temperature, which leads to lower energy requirements for precooling. Mechanical injury must be avoided (see 2.2.5).

2.3 Fresh produce quality management: advice for the design and operation of cold stores

The optimum storage temperature for fruit or vegetables is the lowest temperature at which the fruit quality is retained without adverse effects – see Subsections 2.2.1 on storage temperature and 2.2.6 on chilling injury. Humidity and airspeed control in cold rooms must be balanced to ensure

¹ <http://postharvest.ucdavis.edu/>

produce quality – see Subsection 2.2.3 on water loss. High humidity is important to reduce water loss and prevent shrivelling or wilting, but if relative humidity is too high and condensed droplets of water form on fruit, then micro-organism growth will be faster. High air speed helps to cool down the produce through better heat transfer, but increases water loss. The factors and risks to be balanced in the cold room design and operation regarding temperature, humidity and airflow are illustrated in Table 2.2.

Table 2.2

Effects of temperature, humidity or airspeed in cold rooms on different quality-related factors.

Factors ↘	If temperature is lower:	If temperature is higher:
Respiration	decreases	increases
RH (%)	increases	decreases
Water loss	decreases	increases
Microbial decay	decreases	increases
Ethylene production	decreases	increases
Ethylene sensitivity	decreases	increases
Chilling injury	risk increases	risk decreases

Factors ↘	If RH is lower:	If RH is higher:
Water loss	increases	decreases
Microbial decay	decreases	increases

Factors ↘	If airspeed is lower:	If airspeed is higher:
Rate of cooling	decreases	increases
Water loss	decreases	increases

Green = Beneficial for product quality

Red = Detrimental for product quality

2.3.1 Temperature management

As described in Subsection 2.2.1, temperature control is a powerful tool to preserve the quality of horticulture produce in the postharvest phase. However, the temperature of the air surrounding the product in the cold room can be quite different to the core temperature of produce inside crates. The goal of the cooling system must be to achieve temperatures as close as possible to the storage temperature and to maintain that temperature despite all of the disruptive heat sources of daily use. It is therefore important to monitor both the air temperature inside the cold room and actual core temperatures of produce at regular intervals using a pulp thermometer probe. See Subsection 4.10.2 and Section 7.4.

For precooling, the cooling capacity of the refrigeration equipment must be sufficient to remove the heat stored in the produce from the field and maintain the desired air temperature. Once the target core temperature has been reached, i.e., precooling is over, further heat generated by physiological processes inside the produce must be continuously removed, see Section 4.4.

Temperature fluctuations should be reduced as much as possible, as they affect produce quality and cause water loss, resulting in weight loss. Temperature fluctuations are often due to oversized refrigerating units, and/or operation of the cold room at partial load.

Product management advice regarding 'Temperature':

- Place the crops in shade after harvesting until precooled/stored (see Subsection 7.7.1).
- Minimise delays between harvesting and cooling, aiming for 1 to 2 h maximum (Table 2.3).
- Consider the three generic storage conditions (see Subsection 2.3.6).
- Manage storage temperatures throughout the supply chain (see Section 7.6).

Cold room design advice regarding 'Temperature':

- Set up a shaded holding area near the cold room (see 4.3.4 and the example in Figure 2.4) or near to the harvest area.
- Build a produce precooling area or function to remove field heat prior to storing (see 4.3.4).
- Ensure that it is easy for staff to set and check the optimum storage temperatures and humidity specific for the produce (see Table 2.4).



Figure 2.4

Schematic for a cold room with generous space for loading/unloading in the shade (Giertsen).

Table 2.3

Estimated acceptable delays between harvest and the start of cooling for selected fruit and vegetables. Acceptable here means that these delays do not have a serious impact on quality later in the chain. Conditions in the field and during delays will affect these estimates, with high field temperatures having the biggest negative effects (adapted from *Thompson et al., 2007*).

Acceptable delay (hours)	Fresh produce	Consequence of extended delays between harvest and cooling
Vegetables		
4	broccoli	water and firmness loss, reduced shelf life
4	spinach	water loss
4	sweet corn	sugar loss
4-8	leafy greens	water and crispness loss
8	cauliflower	water loss
8	carrot	water and crispness loss
8	cucumber	water loss, yellowing
8	green beans	water and crispness loss
8	summer squash (soft skin)	water loss
16	tomato	increased decay and rapid ripening
Fruit		
2	berries	water loss, decay, loss of visual quality
8	cantaloupe melon	water loss
8	mandarin	increased rind disorders, decay
8	watermelon	loss of sugar and texture if above 27°C
12	avocado	premature ripening with high fruit maturity
16	honeydew melon	loss of firmness, ripening
16	orange	increased rind disorders, decay
16	pomegranate	water loss
16	persimmon	water loss
24	grapefruit	water loss, increased rind disorders, decay

The acceptable delay times mentioned in this table are times to aim for before cooling begins, but are not always feasible in practice. Longer delays will impact the quality of the produce, especially in high ambient temperatures during harvest. The quality impact of the delay often only shows much later in the last part of the chain, at the final customer.

For many crops, including cabbage, lettuce and onions, the storage temperature is just above the freezing temperature (see Table 2.4). But fruit and vegetables originating from tropical regions (e.g. banana, plantain, mango, papaya and tomato) are sensitive to chilling and must be stored at temperatures above those that induce chilling injury (see Table 2.4).

Table 2.4

Optimal handling conditions for selected fresh fruit and vegetables (compiled from *Cantwell, 2002; Gross et al., 2016*).

Crop	Storage temp (°C)	RH (%)	Ethylene production	Ethylene sensitivity	Approx. storage life (weeks)
Banana	13-15	85-95	M	H	1-4
Cabbage	0	95-100	VL	H	20-24
Carrot	0-1	95-100	VL	H	20-24
Cassava	0-5	85-95	VL	L	4-8
Cocoyam (<i>Xanthosoma</i>)	7-15	80-85	VL	L	12-20
Collards	0	95-100	VL	H	1-2
Courgette (zucchini), summer squash	5-10	90-95	L	M	1-2
Cucumber	10-13	85-90	L	H	1-2
Eggplant (aubergine)	10-12	90-95	L	M	1-2
Lettuce	0	95-100	VL	H	2-3
Loquat	0-5	90-95	-	-	3
Lychee (litchi)	1-5	90-95	M	M	3-5
Mandarin	5-10	90-95	VL	M	2-4
Mango	10-13	85-90	M	M	2-3
Okra	7-10	90-95	L	M	1-2
Onions (dry bulbs)	0	65-75	VL	L	4-32
Onions (green)	0	95-98	L	H	1-4
Orange	3-10	85-95	VL	M	3-12
Papaya	7-13	85-95	M	M	1-3
Pepper, bell pepper	7-10	90-98	L	L	2-3
Pepper, chili	7-13	85-95	L	M	2-3
Pineapple	7-13	85-90	L	L	2-4
Plantain	10-15	90-95	L	H	1-5
Potato	4-15	90-95	VL	M	20-40
Pumpkin, butternut, winter squash	10-15	50-70	L	M	8-12
Sweet potato	13-15	85-95	VL	L	16-28
Swiss chard	0	95-100	VL	H	1-2
Taro (<i>Colocasia</i>)	7-10	95-100	-	-	12
Tomato (mature green)	13-15	90-95	VL	H	2-5
Tomato (red)	10-13	85-95	H	L	1-3
Yam (<i>Dioscorea spp</i>)	14-16	70-80	VL	I	4-28

2.3.2 The need for precooling and options to achieve it

Some of the prominent methods to remove the field heat of fresh produce (precooling) are forced air cooling or hydrocooling. Forced air cooling takes about 1 to 10 h, depending on the total weight, shape, size and type of produce, the packaging design and the operation of the cooling unit. Ideally, forced air cooling will take place in a separate cold room, designed for higher airflow and rapid cooling via the use of a cold wall system or a portable forced air cooling tunnel. North Carolina State Extension provides full details, resources and illustrations on forced air cooling³.

Hydrocooling is usually very rapid (< 1 h) but can only be used on produce that can tolerate wetting. Melon, radish, celery, root crops and sweet corn are often hydro cooled in batches (while still in field containers), either via cold water sprays or immersion in cold water tanks. The water can be cooled via a refrigeration system or by adding ice to achieve the appropriate temperature for the produce. To reduce operational costs for a hydro cooler, the unit should be well insulated, set up in deep shade or inside a cold room, and produce should be harvested early in the morning when air and produce temperatures are naturally cooler. North Carolina State Extension provides full details, resources and illustrations on hydrocooling⁴.

Fresh produce can also be room cooled, but this can take a long duration sometimes up to many days for efficient cooling. It is majorly dependent on packaging type, spacing and fan speed. Although room cooling is slow, it allows precooling to take place in the same cold storage room (Thompson et al., 2002). If room cooling is the chosen route for precooling, then produce should be spread out, rather than packed in stacked boxes, to speed up the process.

Cooling requires heat transfer from produce to a cooling medium with heat transfer by conduction, convection, radiation or evaporation. The rate of cooling is directly related to the temperature difference between the cooling medium and the product. Table 2.5 compares the half-cooling times of apples between different cooling methods and types of packaging (Hall, 1972) as an example of how the time required for the precooling of any crop will be strongly affected by these factors. In practice, one needs a large cooling capacity for room cooling to be effective as precooling. For off-grid WICR, capacity is often limited, which is why a dedicated precooling room or at least a room with increased air circulation is recommended (see Subsections 4.3.4 on design for precooling and 5.1.2.2 for off-grid operation).

Table 2.5

Examples of half-cooling times (h) for apples packed in a box, wrapped and packed in a box, or loose and cooled by room cooling, forced air cooling or hydrocooling (adapted from Hall, 1972).

Note: half-cooling time is the time taken to decrease the pulp temperature halfway between the field temperature and the target temperature and is a commonly-used measure of the rate of cooling.

Cooling method	Half-cooling times (h)
Room - apples packed in box	12
Room - apples wrapped and packed in box	22
Forced air - apples packed in box	4
Forced air - apples wrapped and packed in box	14
Hydrocooling	0.33

³ <https://content.ces.ncsu.edu/forced-air-cooling>

⁴ <https://content.ces.ncsu.edu/hydrocooling>

Product management advice regarding 'Precooling':

- Harvest in the early morning so that produce temperatures are naturally lower. Move produce into the shade immediately after harvest and then to a precooling facility as soon as possible.
- Precool in a separate room or partition, away from produce that is already at the right storage temperature.
- Ensure cooled air can flow around the produce during precooling. Spread out the produce or boxes or ensure gaps between layers and do not over-fill. Avoid placing crates directly on the floor so air can flow underneath.
- Move produce from the precooler to the cold room as soon as it reaches the target temperature to avoid excess water loss (caused by the faster airflow used in precooling).

Cold room design advice regarding 'Precooling':

- Set up a shaded holding area near the cold room (see Subsection 4.3.4).
- Design a separate or partitioned space for precooling, so that stored produce does not get re-heated each time (see Subsection 4.3.4).
- Generate good airflow in the precooling space, including through racks and packaging (see Subsection 4.11.2 and example in Figure 2.5).
- Allow a higher proportion of refrigeration cooling capacity for the precooling space (see Subsection 4.3.4).

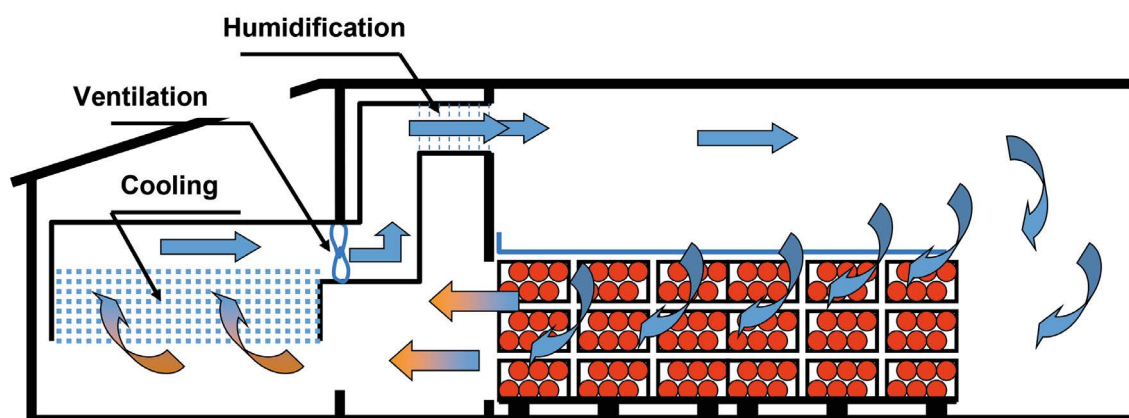

Figure 2.5

Example configuration for precooling of produce, with forced air circulation drawn through the racked produce and in which air is cooled using thermal storage (source: *Solar Cooling Engineering and Josef Streif*).

2.3.3 Relative humidity management

The RH should be kept within the optimum range of 85 to 95% for most commodities to minimise water loss. To achieve 95% RH at 0°C, the mean temperature differential between the air and the evaporator coil in a cold room must be about 0.5°C. Similarly, to maintain 90% RH at 0°C, this difference must be about 1°C (Paull, 1999). Maintaining these small differences requires very accurate temperature measurement, e.g. platinum resistance elements, and the correct sizing of the evaporator and refrigeration unit (Thompson, 2002). Evaporator coils with a large surface area and good controls can maintain a smaller temperature difference between evaporation and air off temperatures and so maintain high relative humidity. Refrigeration systems that are oversized

result in temperature fluctuations as the system cycles on and off. Undersized systems result instead in continuous operation and the condensing of humidity from the air (lowering the relative humidity) and excess frost build up on the coils. This is the case in refrigeration systems that are not designed for fresh produce (e.g. domestic refrigerators) where the coils are often 6°C lower than the storage temperature, which results in high water loss.

Humidification systems can be used in cold rooms to increase relative humidity and reduce the vapour pressure difference VPD, to reduce water loss (but this will quickly end up as water or frost on the evaporator in an undersized system). The simplest way to raise relative humidity is wetting the floors, but it should be considered as an occasional solution, for safety and hygiene reasons. More advanced solutions include fogging or misting water spray systems. The transpiration coefficient can be reduced by any type of packaging, especially plastic packaging, waxes or coatings, careful handling to avoid mechanical injury, or removing leaves to reduce the surface area.

When moist air is cooled, relative humidity increases until it reaches 100% (the dew point), at which point the water vapour starts to condense. Condensation of water encourages microbial and mould growth and increases decay. At low temperatures and high relative humidity, very small differences in temperature (< 0.5°C) can result in condensation on the cooling surfaces. This compromise between minimising water loss and preventing condensation is notable in grapes where high humidity and free water encourage the growth of grey mould (*Botrytis cinerea*) while low humidity causes desiccation and browning of stems and pedicels. Both problems affect the grape quality and profitability.

Product management advice regarding Relative Humidity:

- Adjust relative humidity to 85 to 95% for most commodities to minimise water loss (see Subsection 2.3.3).
- Move harvested produce to shade immediately and keep out of the wind, preferably covered with a moist cloth.
- Move the produce to the cold room as quickly as possible.
- Remove leaves to reduce the surface area for water loss.
- Wet the floor of the cold room if the humidity is lower than optimum.

Cold room design advice regarding Relative Humidity:

- Ensure the system is designed to keep evaporator coil temperature close to the desired storage temperature (a few degrees temperature difference, for example, will result in high water loss and lower quality). This requires investing in a large evaporator size and accurate temperature controls (produce quality will be better; water/weight loss will be lower).
- Design the storage systems to achieve RH within the range of 85% to 95% for most product types to minimise water loss (see Subsection 4.9.4). Wetting the floor is cheap, while spraying or misting systems may be worth considering in larger cold stores. And design to minimise the difference between evaporating temperature and air temperature, e.g., by specifying a generously sized evaporator which will reduce tendency to dry the air (see Subsection 4.3.1).
- Design the cold room floor surface for easy and regular wetting. This means a non-slip (rough) walkway surface; flat to avoid puddles; slight gradient towards free-flow drainage; easy to clean.
- Provide a source of clean water and means to wet the floor in an easy but controlled way.
- Design the walls and all cold surfaces with high humidity and condensation in mind: cleanable surfaces; an allowance for condensation to drain; no crevices or features that will trap water, clog with dirt and grow slimy mould.

2.3.4 Management of fresh air exchange

The air exchange rate (the rate at which the existing air is replaced by fresh) reduces carbon dioxide (CO₂) that builds up from respiration and reduces the ethylene concentration in the cold room. Opening the door results in some air exchange, but generally, for low turnover applications, the recommendation is to design the WICR to allow one air exchange per hour by installing a passive exhaust and an air intake fan (Reid, 2002). This is reasonably effective in reducing ethylene accumulation in the WICR and allowing some exchange to reduce the CO₂ produced by respiration. The greater the air exchange, the lower the ethylene concentration, but this also means higher energy costs as cold air is exchanged with warmer outside air.

Product management advice regarding 'fresh air exchange':

- Be aware of the ethylene production and ethylene sensitivity of produce that is stored, and of likely respiration rates of the produce –use this to proactively manage ventilation.

Cold room design advice regarding 'fresh air exchange':

- To manage CO₂ and ethylene levels, design the cold room ventilation and/or door management to enable around one 'air exchange' per hour – if necessary, through an air intake fan and passive exhaust vent. Ideally, make the system controllable and based on sensor readings so that cold air venting (cooling cost) is minimised.

2.3.5 Ethylene control in the WICR

Managing a WICR includes avoiding the handling or storing of ethylene-sensitive commodities with those that produce ethylene during storage in the WICR. However, this may be difficult to implement especially in developing countries where cold storage is limited, and mixed loads in cold storage are common. In this case, enough fresh air should be introduced into storage rooms to keep the ethylene level minimal (Thompson et al, 1996). Ventilation with fresh air generates a heat load which must be accounted for in the design of the cooling unit (see Subsection 4.14.4).

For high ethylene-producing fresh fruit, viz. apples, ethylene can also be absorbed or scrubbed on commercially available potassium permanganate (KMnO₄) pellets or activated charcoal (Kitinoja and Kader, 2015). Ethylene is oxidised by KMnO₄ packed in sachets placed in boxes or via the use of filters placed in the air recirculation systems in cold rooms. The KMnO₄ must be changed regularly and disposed of safely. Ozone generators or photocatalytic converters have also been used to reduce ethylene concentrations in the cold room (Keller et al., 2013), and can be cost-effective if the ethylene build-up is causing issues with produce quality.

2.3.6 Compatibility of produce types in storage and three typical storage environments

While the ideal condition would be to store every item at its optimum storage temperature, that is not always possible, especially when storing a wide range of commodities together. To combine storage of fruit and vegetables, a compromise must be met on temperature and humidity levels and this compromise shortens the storage potential. In practice, it is possible to compromise by using one of three environments for short-term storage, for example:

1. Cold and humid (0-2°C; 90-98% RH) – most leafy vegetables, brassica crops, and temperate-origin fruit and berries.
2. Cool and humid (7-10°C; 85-95% RH) – citrus and subtropical fruits and many fruit-type vegetables.
3. Moderate (13-18°C; 80-95% RH) – root vegetables, squashes, and most tropical fruit and melons (26 Thompson et al., 1996).

Mixing fruit and vegetables that are high producers of ethylene with those that are moderately to highly sensitive to ethylene will have negative effects. For example, ripe tomatoes are high producers of ethylene while cucumbers are highly sensitive to ethylene (see Table 2.4). Storing them together results in yellowing of cucumbers. Nevertheless, stores operating a limited number of cold storage temperature levels and rooms will probably have to mix less compatible produce (e.g. tomatoes and cucumbers). In this case, fresh air exchange is particularly important to ensure that ethylene does not accumulate (see Subsection 2.3.4).

If only two environments are available for short-term storage, then all produce items that can tolerate cool storage and dairy items should be stored below 5°C and chilling-sensitive items should be stored at about 15°C.

Product management advice regarding 'compatibility of produce':

- Ensure that staff understand the three main temperature environments and the temperature regimes for different products. The pictograms or similar on display can be used to help the staff understand the concept and set up a daily or weekly decision process to manage the cold room controls in line with this.
- Protect produce that dries out the easiest, e.g. with plastic shielding.
- Avoid mixing produce with high ethylene production with produce that is ethylene sensitive, such as ripe tomatoes with cucumbers (see Table 2.4).

Cold room design advice regarding 'compatibility of produce':

- Ensure controls that are easy to set up to achieve each of the three main temperature environments.
- Give staff access to an indicator of both the set point and the achieved conditions.

2.3.7 Airflow and the importance of racking, container types, and packaging materials

Pallets of stacked containers are ideal for storage of a single type of produce that has been precooled. A WICR that is used for mixed loads should have racks or deep shelves to allow easy access and for good airflow around the produce. It is important to allow airflow to reach under the load, between pallet loads and over the top of the containers to achieve and maintain the target temperature uniform inside the cold room. For further guidance on design of racking for cold rooms, see Subsection 4.11.2. For further guidance on stacking for operation, see Subsection 7.7.5.

2.3.8 Design for seasonal variation of usage

For commercial exploitation, different products will often have to be stored over the course of the year because availability will change over the seasons. Most perishable crops will be stored for only a few days, weeks or perhaps as long as a month before the cold room is emptied and a new batch of produce is brought in for storage. It is rare to find a WICR that is used for only one type of produce over the entire year, and leaving the storage room empty will affect its economic feasibility.

If flexibility is needed and the extra cost of larger equipment for cooling and solar power is affordable and justified, then the WICR should be designed to function at a range of temperatures, ideally over the full range from 0°C to 15°C. Too often, cold rooms have been designed for cold storage of tropical crops and then they are unable to operate at lower temperatures needed for cold storage of temperate crops. Storage of temperate crops such as lettuces or cabbages at warmer temperatures will greatly reduce their potential storage life and lower their quality and market value. For further guidance on design of cold rooms for seasonality planning, see Subsection 4.3.5. For further guidance on operation for seasonality and maximising utilisation, see Section 7.6.

2.3.9 Cold storage for other fresh foods

A WICR can also be utilised for the storage of other types of fresh and processed foods. These may include fresh meats, fish/seafood, packaged dairy products (bottled milk, yoghurt) or bottled drinks (fruit juices), packaged fruit pulps or fresh-cut produce. To illustrate the differences, Table 2.6 provides guidance on the recommended temperature for successful cold storage for selected examples of fresh and processed food products. It is important to maintain the lowest storage temperature in the WICR and manage inventory on a first-in-first-out system since most of these foods have a very limited potential shelf life. If relative humidity is not specified, the packaging is moisture-proof and designed to protect the products from water loss during storage (indicated as “wrapped” in the table below).

However, this guide does not address the specific design and operation rules for storing these other types of food – other resource should be consulted to properly plan for addressing these.

Table 2.6

Recommended cold storage conditions for other fresh and processed food products.

Food product	Temperature °C	RH %	Storage potential
Meat			
Beef (fresh cut)	0	Wrapped	1 week
Beef (ground)	-2	Wrapped	1 week
Beef (ground)	0	Wrapped	3 to 5 days
Chicken (whole)	0	95	7 days or less
Chicken (fresh cut)	0	95	5 days or less
Eggs			
Eggs (in shell)	7.2	70-80	2 to 3 weeks
Eggs (in shell)	0	85-90	5 to 6 months
Fish/Seafood			
Fresh fish (whole)	0	Wrapped	8 to 10 days
Shellfish	0	Wrapped	5 days
Shellfish	2	Wrapped	2 to 3 days
Dairy products			
Bottled milk	2	Wrapped	3 to 4 weeks
Yoghurt	1	Wrapped	4 to 5 weeks
Cheeses (fresh, soft)	0	65	2 to 3 weeks
Cheeses (aged, hard)	0	65	6 months to 1 year
Processed fruits and vegetables			
Bottled fresh juice (citrus)	4	Wrapped	2 months
Bottled fresh juice (apple)	0	Wrapped	1 week
Bottled fresh juice (apple)	4	Wrapped	2 days

Sources: Meatscience.org, <https://www.foodsafety.gov/food-safety-charts/cold-food-storage-charts>, GCCA Commodity Storage Handbook (proprietary).

2.4 References

- Becker, B.R., Fricke, B.A., 1996.** Transpiration and respiration of fruits and vegetables, In: New Developments in Refrigeration for Food Safety and Quality (International Institute of Refrigeration).
- Biale, J.B., Young, R.E., 1981.** Respiration and ripening in fruits – retrospect and prospect. In: Friend, J., Rhodes, M.J.C., Recent Advances in the Biochemistry of Fruits and Vegetables, Academic Press, London, UK, 1–39.
- Blakey, R.J., Tesfay, S.Z., Mathaba, N., Bertling, I., Bower, J.P., 2012.** Some initial changes in 'Hass' *avocado* (*Persea americana* Mill.) physiology due to ethephon. International Journal of Postharvest Technology and Innovation, 2(4), 334–344.
- Cantwell, M., 2002.** Appendix: Summary table of optimal handling conditions for fresh produce. In: Kader, A.A., Postharvest Technology of Horticultural Crops. University of California Agriculture and Natural Resources Publication, Oakland, 331, 511-518.
- Domínguez, I., Lafuente, M.T., Hernández-Muñoz, P., Gavara, R., 2016.** Influence of modified atmosphere and ethylene levels on quality attributes of fresh tomatoes (*Lycopersicon esculentum* Mill.). Food Chemistry. 209, 211-219.
- Gross, K.C., Wang, C.Y., Saltveit, M.E., 2016.** USDA Handbook 66: The Commercial Storage of Fruits, Vegetables, and Florist and Nursery Stocks. 792.
- Hall, E.G., 1972.** Precooling and container shipping of citrus fruits. CSIRO Food Research Quarterly. 1(32), 1-10.
- Harker, F.R., Redgwell, R.J., Hallett, I.C., Murray, S.H., and Carter, G., 1997.** Texture of fresh fruit. Horticultural Reviews. 20, 121-224.
- Keller, N., Ducamp, M.N., Robert, D., Keller, V., 2013.** Ethylene removal and fresh product storage: a challenge at the frontiers of chemistry. Toward an approach by photocatalytic oxidation. Chemical Reviews. 113(7), 5029-5070.
- Kitinoja, L., 2013.** Use of Cold Chains for Reducing Food Losses in Developing Countries. PEF White Paper No.13-03, Postharvest Education Foundation, La Pine, OR, USA.
- Kitinoja L., Kader A.A., 2015.** Small-scale postharvest handling practices: a manual for horticultural crops, 5th Edition. Postharvest Technology Research and Information Center, University of California, Davis, CA, USA.
https://ucanr.edu/sites/Postharvest_Technology_Center_/files/231952.pdf. Accessed 30 March 2022.
- Lee, S.K., Kader, A.A., 2000.** Preharvest and postharvest factors influencing vitamin C content of horticultural crops. Postharvest Biology and Technology. 20, 207–220.
- Mahajan, B.V.C., Kaur, T., Gill, M.I.S., Dhaliwal, H.S., Ghuman, B.S., Chahil, B.S., 2010.** Studies on optimization of ripening techniques for banana. Journal of Food Science and Technology. 47(3), 315-319.

Paull, R.E., 1999. Effect of temperature and relative humidity on fresh commodity quality. *Postharvest Biology and Technology*. 15, 263–277.

Reid, M.S., 2002. Ethylene in postharvest technology. In: Kader, A.A., *Postharvest Technology of Horticultural Crops*. University of California Agriculture and Natural Resources Publication, Oakland, CA, USA: 331, 149-162.

Sastry, S.K., Baird, C.D., Buffington, D.E., 1978. Transpiration rates of certain fruits and vegetables. *ASHRAE Transactions*. 84(1), 237-254.

Tavallali, V., Moghadam, M.M., 2015. Postharvest application of AVG and 1-MCP enhance quality of 'Kinnow' mandarin during cold storage. *International Journal of Farming and Allied Sciences*. 4(6), 526-535.

Thompson, J., Kader, A., Sylva, K., 1996. *Compatibility chart for fruits and vegetables in short-term transport or storage*. University of California Agriculture and Natural Resources Publication, Oakland, CA, USA: 21560 (poster).

https://postharvest.ucdavis.edu/Commodity_Resources/Storage_Recommendations/Compatibility_Chart_for_Short-term_Transport_or_Storage/index.cfm

Thompson, J., Cantwell, M., Arpaia, M.L., Kader, A., Crisosto, C., Smilanick, J., 2001. Effect of cooling delays on fruit and vegetables quality. *Perishables Handling Quarterly*. 105, 2-5.

Thompson, J.F., Mitchel, F.G., Rumsey, T.R., Kasmire, R.F., Crisosto, C.H., 2002. Commercial cooling of fruits, vegetables and flowers. University of California Agriculture and Natural Resources Publication, Oakland, CA, USA: 21567, 59 p.



3.

Planning a cold room

3. Planning a cold room

3.1 A roadmap through the process of planning a walk-in cold room

This section provides a roadmap through the process of specifying and delivering a walk-in cold room, from both a technical and business point of view, to ensure it meets the needs of the community it serves. It provides an overview of the steps in the planning process - full detail can be found in the other parts of the guide. It starts from the specification (cooling tasks to be achieved, cooling technology, size of the cold room, site, power supply), and follows through to business aspects (business models, financing routes, procurement), finally to installation, commissioning, operation, and management. Whatever the size of the cold room, it is extremely important to create a clear specification of the needs of the purchaser and business at the start of the design process. Other parts of the guide provide detail and should also be consulted.

Consider getting independent advice: specifying a cold room and planning its integration into an agricultural or horticultural business is complex. A business solution that works in one geographical area and market cannot be simply 'copy-pasted' to work in a different area. Project managers should seek professional, trusted and preferably reasonably local advice on any aspects on which they lack confidence. This guide identifies the important topics that must be investigated, discussed and agreed and will help prepare for productive discussions with experts. It cannot provide a ready solution but will help the project manager prepare for meetings: what questions to ask, what essential information about the needs and situation must be shared so that experts they talk with can do their job well. Some advice will come from equipment suppliers, but they will not be able to appreciate the full context and even well-intentioned partial advice may not be well suited to the situation. Investment in an independent expert who comes recommended or with good references, who knows the local produce market and available technical services, who is paid to understand the full picture, working closely with the project manager to develop the solution, will usually provide value for money.

The steps in the roadmap are shown in the flowchart in Figure 3.1, Figure 3.2 and Figure 3.3 and are listed in simple terms below. Each step is described in the sub-sections that follow:

1. Is an electric powered walk-in cold room the right solution for this situation? (see 3.2)
2. Describe and quantify the cooling tasks (see 3.3)
3. Choose the most likely indicative size and type of cold room needed (see 3.4)
4. Identify a possible site for the cold room (see 3.5)
5. Select a power supply type (see 3.6 and Part 5)
6. Choose the most likely business model (see 3.7)
7. Identify financing routes (see 3.8)
8. Draw up the outline technical specification (see 3.9)
9. Go/No-go decision stage (see 3.10)
10. Run the tender or procurement process (see 3.11)
11. Installation and commissioning (see 3.12)
12. Operation and management (see 3.13)

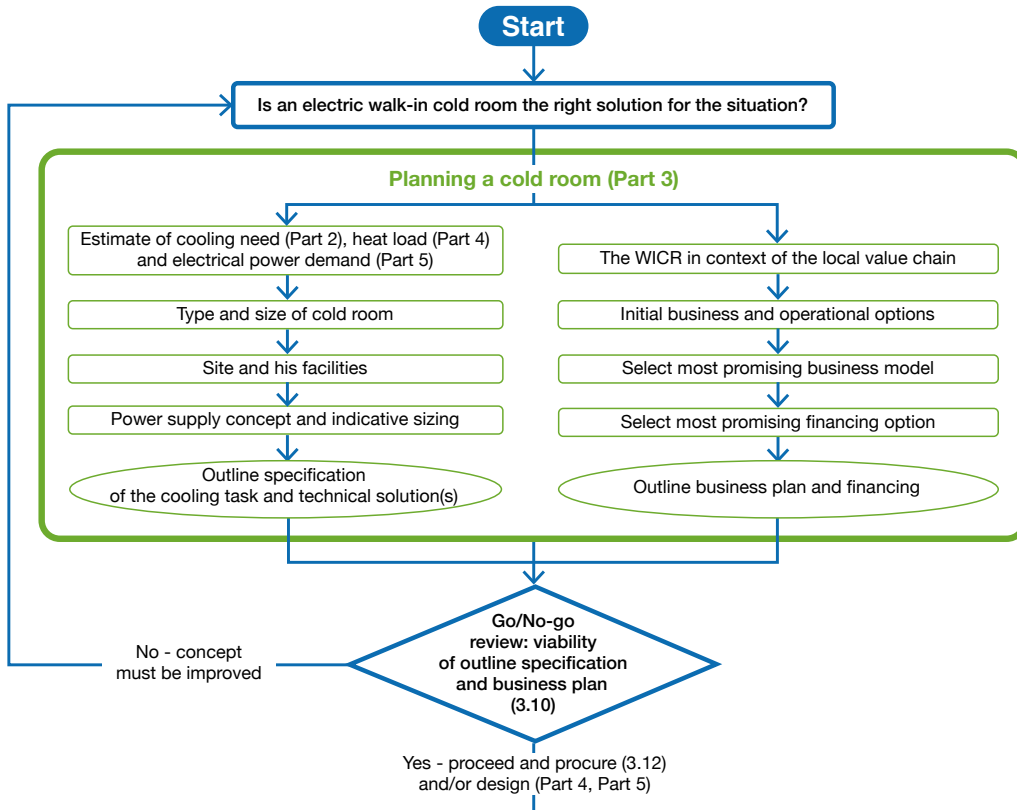

Figure 3.1

Flowchart illustrating the steps to develop the concept and outline design of a walk-in cold room business through to the Go/No-go review stage (first stage of three).

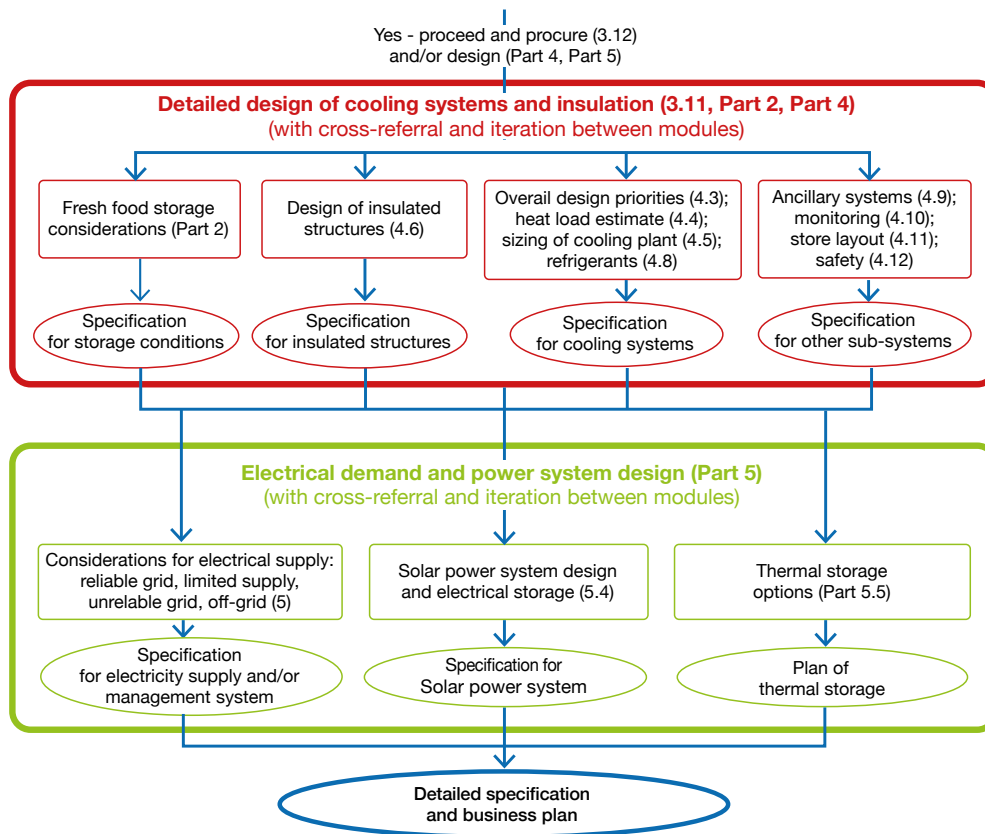

Figure 3.2

Flowchart illustrating the steps to develop the detailed design of a walk-in cold room through to the detailed specification (second stage of three).

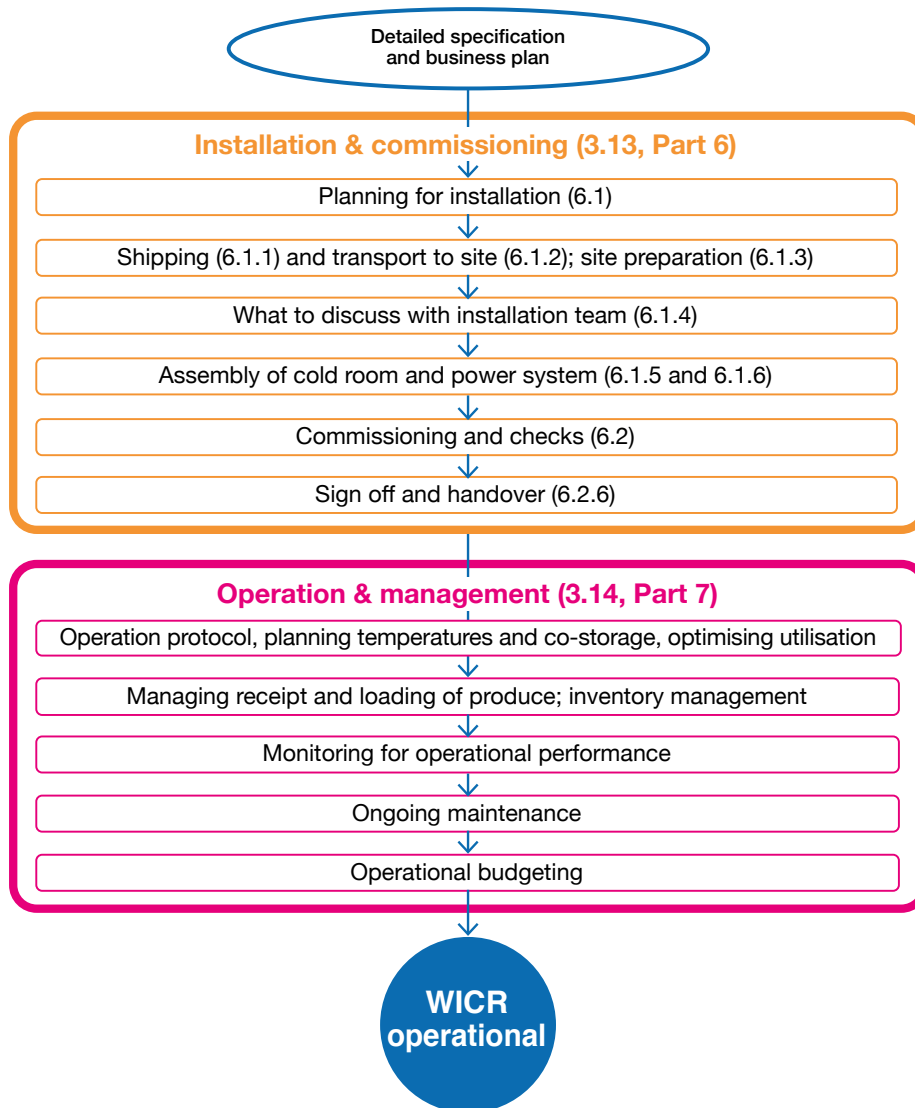

Figure 3.3

Flowchart illustrating the steps of installation, commissioning and then operation and management of a walk-in cold room business (third stage of three).

3.2 Is an electric powered walk-in cold room the right solution for this situation?

Cooling is an effective way to preserve postharvest quality of perishable products but before building a walk-in cold room it is important to assess whether it is the right solution for the problem. Cooling in agriculture is not always needed. But it is one of the means that, under the right circumstances, can reduce waste and improve quality and profitability, therefore it is important to review if electrical cooling is right for any given situation. Consider also how the cold room fits into the business plan (Section 3.7)

This guide is focused on electrically powered vapour compression cycle refrigeration equipment which is reliable if well designed and maintained but requires investment that may be beyond the reach of many small farmers and communities. Many other more affordable solutions are possible and could be more suitable in many applications.

If the goal is to improve food and nutrition security through accessibility, it can be less expensive to extend the production season, implement irrigation, preserve food by other means such as drying or improve market connectivity by other means, rather than cooling.

Cooling adds cost to the postharvest chain, and viable and sustainable operation of a cold room facility is only feasible if investments and operational cost can be earned back. Effective use of a cold room, where previously no mechanical cooling was used, almost always requires a complete re-design of how an agricultural business functions, plans its planting and its access to markets (see Section 3.7).

For this purpose, Wageningen University in the Netherlands has published the Postharvest Assessment Methodology (Oostweche et al, 2022). This method serves as a stepping stone in the development of business plans (Section 3.7) and access to finance for investments. Currently, the PHAM is used in multiple projects for donors and development banks, in collaboration with the private sector (Subsection 3.7.1).

Some alternatives to electrically powered WICR cooling are identified below – other resources are available to help on these:

- Passive cooling solutions and natural ventilation: Many types possible, including use of clamps (shallow burying), covering with straw in the field, use of shading, or storage sheds designed to allow air flow over and through stacked or crated produce and warm and moist air vents higher up the structure. This can be effective for produce that stores well under natural conditions such as potato, onions, sweet potato, garlic, pumpkins. Enhancements include store designs using a 'chimney effect' to accelerate air flow, and enabling higher ventilation when outside conditions are cooler, such as at night.
- Evaporative cooling: Evaporation of water offers low-cost cooling for small batches of product and can be achieved in clay pots or simply through water spray and air movement¹. Evaporative cooling is suitable for tropical/sub-tropical crops and is most effective in hot and dry climates which are known under the Köppen Climate classification as 'BWh' (dry/desert/hot & arid) and 'BSh' (dry/steppe/hot and arid)². Evaporative cooling can be used in low humidity environments, up to around 40% relative humidity. Temperatures can be reduced through evaporative cooling to 2-3 °C above the dew point at best.

¹ *Evaporative Cooling Best Practices Guide*, Eric Verploegen, Peter Rinker, Kukom Edoh Ognakossan, MIT D-Lab, June 2018. Available from: <http://d-lab.mit.edu/resources/publications/evaporative-cooling-best-practices-guide>.

² Areas with classifications BWh and BSh are identified on a world map at <http://hanschen.org/koppen>.

- Ice cooling: For produce immune to being wet and that is ice tolerant (not harmed by temperatures of around 0°C) – such as broccoli, cabbage, leek, sweet corn – ice can be crushed and layered on top of the produce in its crates. Cooling is achieved by the melting of the ice, by contact with cold water and by evaporative effects. Downsides include that cooling is effective for a limited time after ice is placed in the crates (several hours and highly dependent on ambient conditions); larger crates are needed; the crates are much heavier for transport with the ice; produce and its container and storage areas get very wet (risk of mould and pathogens).

3.3 Summary of cooling tasks and maximum electrical power

The storage requirements for fresh produce in terms of temperature, humidity, ventilation and more are described in Part 2 and translated into technical specifications in Part 4. Precooling to remove field heat immediately after harvest has specific requirements in terms of cooling power, and a dedicated chiller must almost always be used in order to avoid deterioration of quality of the produce due to a slow cooling rate (see design Subsection 4.3.4). If precooling is achieved in a cold room where other produce is already stored, quality deterioration will affect both.

Design of a refrigeration system and the power supply to drive it is inevitably an iterative process as cooling needs and aspects of the system design are refined. See Section 4.4 for full detail on how to quantify the cooling load, but this section sets that into context, outlining the cooling load and electrical power needs to help project managers discuss details with designers and suppliers as summarised in Figure 3.4:

- An estimation of the total heat load can be made by adding up the relevant elements identified in 4.4, including understanding how each load varies during a day and over seasons to determine a 'Design Day' cooling load. This is a compromise cooling demand and profile set somewhere above 'typical demand' but recognising the cost implications of trying to be able to meet the 'Peak-of-the-year' demand level.
- Once a base heat load is determined, the cooling capacity of the refrigeration system must match this heat load or the produce will spoil. This gives the designer a good basis to decide what level of baseload and higher cooling demand to design for, as explained in 4.5. Some or most of cooling requirements can be met using thermal storage so that the plant is sized to be smaller, less expensive and more energy efficient. Surplus cooling capacity of the unit can be used to load up thermal storage to meet subsequent higher cooling demands. Considerations for use of thermal storage are given in Section 5.5.
- If this cooling capacity is to be met by a packaged cooling system, the specification of the cooling system will indicate the electrical demand. If a bespoke system is being assembled, the Coefficient Of Performance (COP) of the system can be estimated to derive an estimate of the electrical demand of the compressor (Subsection 4.10.3).
- Then electrical demands of all other system components can be added to estimate the overall electrical demand (Section 4.7).
- Then the electrical system can be specified to deliver that electrical demand, with an associated cost estimate (Part 5).
- Then iteration can begin to reduce demand and/or optimise design and achieve a feasible cost.

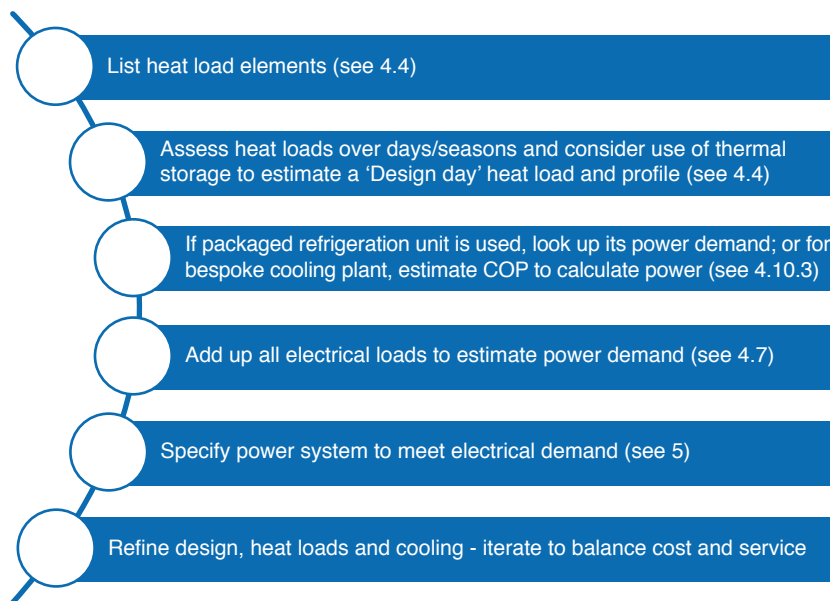

Figure 3.4

Overview of the process to describe and quantify cooling needs then estimate the electrical power needs of the cold room.

3.4 Type and size of cold room

This guide is focused on 'Walk-in cold rooms' (WICR), which means a type of cold room with at least one door that is large enough for a person to walk in to. Such stores serve cooperatives, fresh food suppliers, markets communities smallholder and SME farmers. The guide covers site-built and 'containerised' solutions, standalone structures and those within another building. Scope of power supplies covered are reliable grid, limited grid, unreliable grid and off-grid, with a particular focus on solar photovoltaic renewable energy source (see Section 3.6 and Part 5). Commonly seen types of cold room for these target markets are described briefly in this section. Bear in mind that any cooling and electrical system will need maintenance and therefore involving local technicians from the outset builds capacity to provide longer term service. Local assembly and manufacturing of cold rooms help create a more stable local supply chain and local jobs and should therefore be considered. A study published by the Efficiency for Access coalition in March 2023 examined the status and scope for increasing localisation of supply chains for WICR (Efficiency for Access 2023a). Amongst other positive outcomes found for increasing localisation of supply was the scope to reduce the overall cost of the WICR due to the reduction or avoidance of import tax duties and shipping.

3.4.1 Pre-assembled cold rooms

Most commercially available solar photovoltaic driven cold rooms are complete factory assembled units delivered to site as complete structures, with no on-site assembly required, see example in Figure 3.5. The shape and size tend to be similar to either a 20 ft or 40 ft standard shipping container to make them easier to handle and transport at reasonable cost. But these are usually specially made and are not reused ISO international shipping refrigerated containers. Self-contained designs minimise site work and most are installed at remote locations with the only site work being preparation of foundations or stable base, set up solar PV modules and providing shade to reduce solar heat gain into the cold room. This is sometimes achieved by placing solar PV modules on top of the cold room. Rooms of less than 30 m³ are generally self-supporting structures with insulated panels fitted into or inside a metal frame.



Figure 3.5

Example of a pre-assembled cold room that is shipped to site ready for use (*FreshBox*).

3.4.2 Prefabricated ('flat packed') cold room kits

These are kits made of prefabricated insulated sandwich panels, containing all components needed to construct the cold room. They are delivered to installation sites ready to lock together with mechanical joints between panels, with little or no rework of the sandwich panels, and can be with insulated floor or without insulated floor, example kit is shown in Figure 3.6. Site-assembled solar-driven solutions are available to standard designs, but few are sold due to being dependent on local specialist expertise and supply chains. Further details on the insulated sandwich panels and their installation are given in Section 4.6.



Figure 3.6

Example of 'flat-packed', pre-cut and jointed cold room insulation panels being unloaded for assembly (*Sonja Mettenleiter, Solar Cooling Engineering*).

3.4.3 Refrigerated ISO containers (reefers) and similar

Refrigerated transportation equipment such as reefers (refrigerated ISO containers), railway cars, highway vans or marine containers can provide extremely robust and reliable cooling. Many companies supply cold rooms based on shipping containers as they are simple to move where crane access is possible and do not require much on-site installation. Some are self-powered (e.g., diesel generator) or with auxiliary power unit or take electrical mains input. Many suppliers are now providing solar modules for off-grid or unreliable grid operation, instead of diesel generators which require refuelling and maintenance and are not sustainable from an environmental standpoint. They are especially applicable in locations where the users do not own the land where the cold room is located as it can be moved when necessary. Most reefers in stationary use are 20 ft container sizes (6.09 m long and 33.2 m³ internal volume) and offer fully flexible temperature control (chilled or frozen).

There are two main disadvantages to using any ex-transport vehicle for stationary cold storage:

1. Reefer doors are heavy and designed to remain shut for almost the entire usage time – they are not easy to open multiple times a day and can carry safety risk for users accidentally trapped inside. Some units are modified for stationary use with more suitable doors.
2. They are not designed for high relative humidity storage conditions. Wetting the floor or walls to increase humidity leads to corrosion, mould and reduced equipment life.

Stationary containers intended for cold room application are usually fitted with features such as thermal curtains, larger and more ergonomic handles, wider doors, emergency exit doors and flat floors instead of T-bar floor, whose failure is not uncommon in case of frequent loading operations, and whose repair is prohibitively expensive.



Figure 3.7

A reefer or refrigerated container as used throughout the world for shipping perishable produce.

3.4.4 Self-built cold rooms

Small WICR can be designed and self-built using locally available materials and traditional mechanical refrigeration systems. Or air conditioning units can also be adapted by artificially heating the air temperature sensor which tricks the unit into cooling the room to a lower temperature³. This can be effective for some simple types of produce and usage scenarios. Fully tailored designs built on site to suit a single situation are so far rare in the markets targeted by this guide (limited grid/off grid). But several training colleges in Africa now run courses in design and assembly of walk-in cold rooms and help make self-built projects viable, once the supply chain for equipment and spare parts is operational. This helps build local skills and capacity that will be invaluable to keep the cold room running for many years.

Further considerations on self-built cold rooms can be found in Subsection 4.6.6.

³ Project by Smart Villages Research Group in Uganda: <https://storage.googleapis.com/e4a-website-assets/Innovator-Series-SVRG.pdf>



Figure 3.8

Example of a cold room built primarily from locally available materials near Matugga, north of Kampala in Uganda (source: Smart Villages Research Group).

3.4.5 Shipping container cold rooms

The most easily available ISO shipping containers, also called freight, 'dry' or intermodal containers, are unrefrigerated and non-insulated but can be converted into cold rooms with considerable effort, with an example shown in Figure 3.9. The most common size by far in general shipping use is the 40 ft/12.18 m long (67.6 m³). Also, 20 ft/6.09 m (33.1 m³) and 10 ft (3.04 m) long ('cube') variants are available in smaller numbers. For most locations 20 ft containers are likely to be the most suitable as cold rooms with internal dimensions 5.9 m long x 2.35 m wide x 2.39 m high and internal volume 33.1 m³. A structure of this size is suitable as a starter cold room and as its units are modular, it is relatively simple to add additional units if required. ISO containers must be insulated and have a cooling system fitted: internal insulation is the most common with gaps between the container wall and insulation panels filled with expanded polyurethane foam. A refrigeration unit would need to be added and structural work carried out to fit the evaporator. Solar power system frames can be welded, or mechanically fastened to these ISO containers. The doors or at least the closure mechanism would have to be replaced to be easier to open and close and – most importantly – to be safe so that a person could never be trapped inside.



Figure 3.9

Example of an ISO shipping container converted into a cold room for use in rural areas (*Solarcool*).

3.4.6 Size of the cold room

The decision on size will depend firstly on the quantity of produce to be stored but also on layout of the room (racks and aisles), the anticipated product mix and weights, how accessible different products must be (short-term storage of a few hours needs much faster and easier access than longer-term storage for weeks), how uniform the size of cartons and pallets is, and the handling equipment to be used. The space occupied by produce depends on the packaging and product form, and aisle space must be sufficient for ease of movement of goods and for staff to turn whilst holding crates, etc. Generally, a higher percentage of space is required for aisles, which are most efficient if laid out in a straight line. Larger chambers allow closer control of temperature and relative humidity due to higher thermal inertia, as well as better use of storage space, but they also mean higher investment costs. Racks should have castor wheels to facilitate easy movement and cleaning, but wheel locks should be used.

3.5 Site for the cold room

Before moving to the development of detailed designs, important aspects must be considered such as infrastructure at the preferred location and availability of staff. Logistical access to the site must be checked, not only to transport the cold room components to site for construction but of course for all future produce that is stored.

A site survey should be done at the planning stage also to investigate the load-bearing capability of the subsoil and establish site work necessary to level and prepare suitable foundations. Checks should also be made to ensure no risk of flooding or earthquakes. Space should be available to store produce on arrival in shade to minimise heat gain. The cold room itself should also be shaded from direct sun, which could be provided by the solar module array. Finally, electricity sources should be assessed; if solar energy supply is considered, a shading analysis must be carried out on where photovoltaic modules are to be located. Shade on the solar modules should be avoided also by control of vegetation.

Approval of the planning authorities must be sought, which will depend on 'local' rules and regulations, and needs should be established at the start of the design process.

More detailed specifications for the purchaser before placing a contract with a supplier are outlined in Section 3.9.

3.6 Power supply type

This guide focuses on providing reliable electricity to sustain acceptable storage temperatures. Particular attention is given to overcome challenging electricity supply situations at both grid-connected sites and off-grid sites.

3.6.1 Power availability, quality and reliability. PV systems, backup generators

Cold storage is typically powered by electricity, or directly by fossil fuel (diesel) driven motor, or by a heat source in the case of absorption cooling. This guide will focus on electrically driven vapour compression systems that are the most common method of refrigeration. Electrically driven vapour compression systems require access to electricity. To design a power system for a cold room, first determine the access to electric supply for a specific location anywhere between

a remote off-grid village and a large population centre with reliable grid. With the electrical load specifications and energy storage autonomy given by the cooling system designer/supplier, site-specific project details are taken into consideration. Site-specific electricity supply options may exist and choosing the supply will be based on deciding which is the most reliable, most affordable, and most environmentally responsible option.

A *grid* is a 'network of power plants, substations, transformers, wires, sensors and poles that carry electricity sometimes hundreds of miles to be distributed' to electricity consumers. For this guide we define *off-grid* as 'any site not connected to the grid'.

The power supply at any site may be one or more of the following:

- Reliable grid, meaning an electrical grid connection with sufficient quality of voltage and frequency and continuity of supply so that the cold room can be operated reliably (few outages often with warning; reasonable voltage stability).
- Limited supply, meaning an electrical supply of reasonable or good quality but operating hours of less than 24 per day, and for which availability is usually known in advance so that cold room operation can be sustained (examples of limited supplies include solar arrays, renewable source such as wind or a mini-grid operating for limited hours per day, and in all of these cases battery or other back up measured can be part of the business and operational plan).
- Unreliable grid, meaning a connection to an electrical grid is available but power is subject to highly variable quality and reliability often without prior notice of problems, which prevents any reliable operation of the cold room – some form of backup power is essential.
- Off-grid supply, meaning that no electricity grid connection is available at the site and a standalone generation system is therefore required.

Further information to characterise these supply types is given in Subsection 5.2.1.

Electricity supply is most easily obtained by connecting to a public utility or a private reliable supply grid. Reliable grid systems are characterised by an organisation that provides electricity, distribution, operations and maintenance (O&M) services to a broad range of customers. Customers are often entirely dependent on these services and may have little input to the organisation operational decisions. Typically, when there is access to a reliable grid with at least 22 hours of electricity availability per day, it is advisable to consider connecting the cold room to that grid because of sustained supply of electric power coupled with low capital investment on the part of the cold room owner. However, backup energy may be advisable and thermal energy storage may even provide financial benefits by shifting electricity consumption to a time of the day when the grid has a rate structure that rewards electricity consumption occurring during off-peak times, when there is less demand. Grid electricity quality varies widely raising the consideration of grid power conditioning equipment (e.g. voltage stabilisers) to prevent damage and premature component failure.

When the grid is limited, that is, it is available less than about 22 hours per day (e.g. a village with few hours generator running) or can suffer outages unexpected or longer than 2 consecutive hours, an important design decision will be based on the need for sustained cold storage. Cold storage can be provided by a backup electrical system to provide continual cooling equipment operation or by incorporating cold thermal storage components to outlast a power outage – or a combination of both.

A valuable but temperature sensitive product may justify having a long duration cold storage backup to overcome an outage, while less sensitive products – or cases where alternate cold storage can be used – may justify shorter duration cold storage backup. Considerations for this are introduced in Section 3.3 and detailed in Part 5 and must be known to select the most appropriate energy supply.

For general grid options (reliable and limited grids) Figure 3.10 gives some supply strategies.

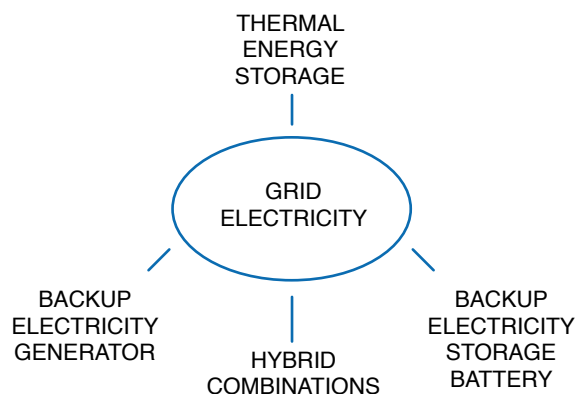

Figure 3.10
Grid electricity strategies for reliable and limited grids.

Where the site is off grid – or the grid is limited or unreliable –, there are options including on-site electricity generators, both fossil fuel-fired and renewable energy-driven. The options with fossil fuel-fired electric generators have several serious shortcomings (see Subsection 5.2.4.2), including high maintenance and repair burdens, ongoing fuel costs, vulnerability to fuel supply disruptions, as well as significant risk of fuel cost fluctuations and negative environmental impacts. Renewable energy resources (e.g., hydro, wind, biomass conversion) are all possible options; however, the most common approach for off-grid cold rooms appears to be the generation of electricity from solar radiation by photovoltaic (PV) systems (Figure 3.11).

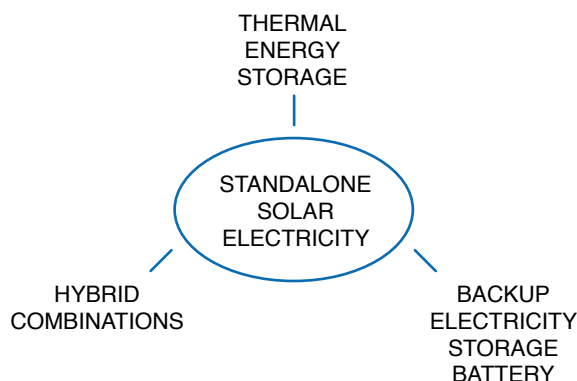

Figure 3.11
Electricity strategies for unreliable grid and off grid.

Solar PV systems have the advantage of using an environmentally clean, free energy input resource that is not vulnerable to artificial supply disruptions. The possible life span of quality solar PV modules is now widely recognized as 30+ years by industry and electric utility companies. A mature PV industry has developed over the last 40+ years and PV-powered industrial and cold chain installations are routinely occurring globally.

Historically, PV-powered systems have relied on electrical storage batteries to sustain load operation overnight and through periods of low solar insolation. However, electric storage batteries are initially costly and involve additional maintenance burdens and eventual replacement cost. Lifespan of the battery system varies by battery type, where even industrial quality lead acid batteries may last just five years or less in tropical conditions. Batteries and required system components were found to account for most failures of PV solar-powered vaccine refrigerators (McCarney et al, 2013). The high failure rate of battery-based solar vaccine cooling inspired the development of thermal energy storage (TES) systems that allowed the PV solar vaccine refrigerators of today to become ‘battery free’.

Cold room designs that minimise the need for electrical storage batteries will reduce a major obstacle to reliability and sustainability in all applications. The introduction of batteries brings on recurring costs and burdens for battery maintenance and replacement. The type and capacity of any energy storage system (thermal or electrical) will need to match the energy input source, the load needs and the estimated time of service. Minimising energy consumption requirements of the cold room structure, lighting, electronic and mechanical equipment will support minimising any energy storage system size and cost, as well as other mechanical and electrical components.

Once the cold room thermal and autonomy requirements are known, the cooling equipment supplier will estimate system requirements and provide the power system supplier with the required electrical loads. The power system supplier will need to also have details of any thermal energy storage systems to design an appropriate power system. Selecting the appropriate electricity source is detailed in Section 5.2. When the selection results in a solar-powered system, readers can see specific solar power consideration and details described in Section 5.3.

3.6.2 Phasing of cooling demand with power availability – Energy storage

Once the cooling needs and therefore the required electrical energy profile are known, this should be phased with the electrical energy supply. This is not a problem if the system is connected to a reliable grid, which can supply the required energy at every hour of the day. However, in the case of limited grid, or when solar energy is to be exploited at its best, the chances to phase energy demand and supply correctly are quite low. In this case, solar energy cannot be collected and made available during nighttime or in the event of cloudy days. That is why energy storage should be considered. Energy can be collected and stored both as electrical energy, before the refrigerating unit, or thermal energy, after the refrigerating unit. Hybrid systems, with both, can also be considered.

Electrical storage is performed by means of batteries, recharged when extra production of energy from solar PV panels is available. Electrical energy is then released when solar PV panels are not able to supply sufficient power to run the refrigerating unit.

Thermal storage is instead performed by storing thermal energy in high thermal capacity fluids or in Phase Change Materials (PCM). In the event of electrical power failure, discharging this thermal storage allows some autonomy to the system, supplying some cooling power previously stored.

Detailed information on both storage systems, their design and their costs and pros and cons are available in Section 5, specially devoted to energy supply and storage systems.

3.7 Business models

3.7.1 Introduction

Walk-in cold rooms are an advanced piece of technology, offering a significant potential for a wide range of cooling applications. But as with any other appliances, WICRs are designed for a specific purpose and their use is only sustainable if the entire process from the very first planning to the actual usage is well thought through. Following the use of good quality, high performance and highly efficient components and an overall system design that is fit for purpose, innovative and well-executed business models are the key pre-requisite to success.

Business models pursued by WICR operators can only become sustainable if they reflect both the customers and operators' needs and ability to economically sustain the investment. For example, it is evident that access to high-performing WICRs can contribute to income increase and stabilisation for farmers and market vendors, while reducing postharvest losses. Furthermore, access to WICRs enables farmers not to be forced to sell their agricultural produce and food at discounted prices in fear of food spoilage but choose to sell their produce when demand and prices are appropriate (University of Birmingham, 2017). Despite this transformational potential, smallholder farmer groups tend to be disaggregated and their volume of produce and revenues generated are usually not sufficient to afford the high investment costs for efficient, solar-powered WICRs. Therefore, business models targeting businesses with severe financial restrictions need to address this challenge replace, for example through offering service-based models.

In addition to overcoming the capital investment barrier, viable business models need to enable effective operations of the WICR. An example use case is a WICR operated by an aggregator, an entity that buys produce from various farmers and sells it in bulk, with the purpose of increasing the shelf-life of their produce or having a buffer capacity of cooled raw product before processing or off-take. Another use case is locating a WICR in a village market to store fresh fruits, vegetables, and other perishable foods, for small vendors who pay daily to keep their crates of produce fresh until it is sold. Viable business models for the same WICR technology can therefore look very different, which needs to be considered as one of the first steps in the planning process of deploying the WICR. Wageningen's Postharvest Assessment Methodology (Oostweche et al, 2022) could be used as a first check of economic feasibility and business model suitability.

Close collaboration between the public and private actors is key to ensure affordability and availability of WICRs. Despite the numerous benefits of better-quality, temperature-controlled environment for fresh produce, the high cost of acquiring, operating and maintaining a WICR can be challenging to sustain because consumers in emerging markets are often unwilling or unable to pay a premium price for it⁴. In addition, emerging economies often lack the cooling infrastructure and equipment, such as refrigerated storage and trucks, and most governments do not have the resources to plan cold chain investment projects. Therefore, it is essential to mobilise private capital to invest in the cold chain infrastructure and leverage philanthropic and grant funds to determine viable private sector-led business models to support more effective deployment in emerging markets. Governments have a critical role to play in creating the enabling environment for the mobilisation of private sector capital and may even take an active role through Public-Private Partnership models, as described in Section 3.8. It should be noted that the importance of cooling is becoming increasingly recognised by African governments, including Nigeria, Rwanda⁵ and Kenya⁶, who have all published their National Cooling Action Plans.

When choosing a viable business model, it is important to consider factors such as market demand, affordability of the service, available funding, and the level of technical expertise required for operation and maintenance. In this section, we discuss the most promising business models to accelerate and facilitate deployment of energy-efficient, solar-powered WICRs.

⁴ *Temperature-controlled logistics: Essential for Health and Growth*. IFC. <https://documents1.worldbank.org/curated/en/389091613394389779/pdf/Temperature-Controlled-Logistics-Essential-for-Health-and-Growth.pdf>

⁵ *Rwanda National Cooling Strategy*. https://www.rema.gov.rw/fileadmin/templates/Documents/National_Cooling_System_book_-_Print__1_.pdf

⁶ *National Cooling Action Plan for Kenya*. https://www.environment.go.ke/wp-content/uploads/2023/06/230607_NCAP-for-Kenya22high.pdf

The selected business model has a direct impact on most stakeholders within the WICR value chain. Figure 3.12 summarises the key roles across the WICR project cycle. However, it should be noted that some stakeholders hold multiple roles within the diagram. For example, some vertically integrated companies manufacture, develop and operate WICRs, whereas others specialise only in one or two of these roles. A more detailed taxonomy of WICR business model roles is outlined in the Efficiency for Access Assessment of the Cold Chain Market in India report (Efficiency for Access , 2023b).

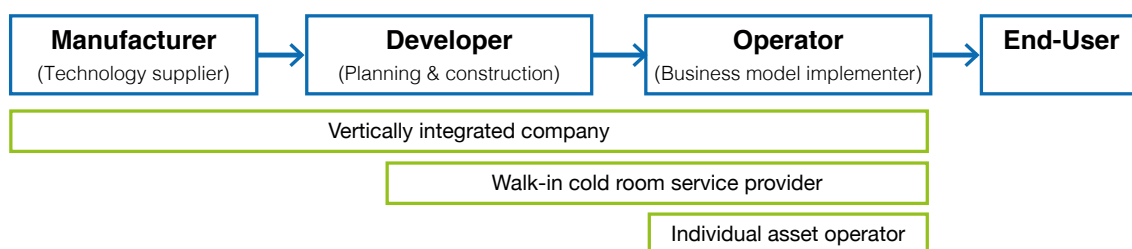

Figure 3.12

Key business model stakeholders across the walk-in cold room value chain.

3.7.2 Prerequisites for a sustainable walk-in cold room business

Identify value chains with the highest potential: Selecting appropriate value chain(s) is arguably the single most important prerequisite for a viable WICR business model. Detailed value chain assessment is complex and time consuming, but it pays off. The prospective WICR operator needs to consider climate conditions, type of produce suitable for the location, projected volumes, seasonality of supply and demand, and pricing plans, which all add up to the utilisation rate and pathway to profitability. Impact-driven WICR operators also need to consider how to reduce postharvest losses, improve food security, reach marginalised farmers, and reduce price fluctuations driven by market demand. Certain trade-offs are inevitable. For example, some value chains may suffer from higher postharvest losses, but the market price is too low to justify the capital investment in the WICR. Therefore, it is key to conduct detailed research to understand all the advantages and disadvantages of certain value chains. The value chain-driven approach is pursued by pioneering WICR organisations such as SELCO Foundation and SokoFresh, who often spend more than six months developing sufficient understanding of the local market dynamics and conditions before the decision on WICR deployment is made. Careful market development strategies with consideration of local production and value chain market patterns should underpin the WICR approach for long-term sustainability. As mentioned previously, following Wageningen’s Postharvest Assessment Methodology (Oostweche et al, 2022) could be useful for a robust value chain market analysis.

Ensure reliable market access to create good logistics and operations: The business model and market opportunity must support the requirement for cooling since WICRs are capital intensive and not always appropriate. If there is an economic need for cold storage, then success also requires the right channels to market with access to physical transport infrastructure such as roads and railways, and identification of produce buyers for local, national, and international markets to unlock business viability. It also includes operational aspects to serve certain market segments such as certification for export.

Design the operational and business model for high utilisation rates: To ensure an acceptable return on investment, the WICR operation must typically achieve a consistently high utilisation rate. This ideally means a strategic location as a supply chain node where there can be appropriate access to market. For seasonal produce, a high utilisation rate could also be achieved by moving the WICR to different locations depending on the season.

Guiding questions to identify a viable business model⁷:

- **Market linkage:** market type to sell the produce (local – village market; regional – large town market; export – shipping port, airport or large city), distance to market, type of road infrastructure, existing means of transport including type, cost and frequency – all these considerations are key to shape the price the farmer or marketplace vendors will secure, which will be a key determinant in their decision making as to whether they will sell their produce to the WICR operator (i.e. aggregator) or see value in using the WICR themselves.
- **Value chain related:** type of produce, seasonality, volume, precooling and cooling needs (preferred temperature and relative humidity), storage duration, farming practices.
- **Type of users:** farmers, farmer groups, producer organisations and cooperatives, marketplace vendors.
- **User profile:** number of users, type and diversity of users' income streams, actual income from farming/trading (e.g., per month/season, ideally cross-referenced with volume and value chain type including any price fluctuations).
- **Cold storage specific:** current or previous experience with WICR (important for capacity building planning), interest in using WICR, preference for lease-to-own versus service-based contracts, land ownership of the potential WICR site.
- **Competing forces:** recognising that WICR are part of a food system, it might sometimes prove to be more economical to keep products in ambient conditions rather than cooling them. Comparing WICRs with other technologies is also key. For example, extending the production season of certain value chains through the integration of greenhouse technologies can sometimes be more economical than cold storage. These are just two examples of competing forces, which need to be considered when validating the viability of the WICR business model.

3.7.3 Overview of the main walk-in cold room business models

Adopting a fit-for-purpose business model is key to ensure commercial viability and avoid the risk of default and stranded assets. Although a WICR developer may not always be directly involved in the interaction with end users, it is important for them to understand what business model will be pursued by the operator to avoid non-payment and reputational risks. The main types of business models relevant to solar-powered WICRs in the Global South are listed below, and their key advantages and challenges from a WICR owner perspective are summarised in Table 3.1. Each model is further explained with examples in Subsection 3.7.5.

- Rental model
- Pay-as-you-store model
- Aggregator model
- Lease-to-own model
- Upfront payment model
- Mobile services model

⁷ Interview with the SELCO Foundation

Table 3.1

Overview of the main walk-in cold room business models.

Business model	Brief description	Delivery model	Advantages	Challenges
Rental model	Monthly/seasonal fee	Service-based	<ul style="list-style-type: none"> • Provides services without the need for user ownership • Often includes remote monitoring <p>Incentivises high efficiency and performance</p>	<ul style="list-style-type: none"> • Substantial amount of capital financing required for the WICR operator (i.e. longer repayment period) • Users need to subscribe to a certain period even if they do not fully utilise their allocated cold room space • Training required for multiple users if they store the produce themselves • Often monocrop-focused and therefore highly dependent on seasonal market prices (i.e. exposure to market risks for end-users)
Pay-as-you-store model	Daily fee per use (based on kilograms, litres or crates)	Service-based	<ul style="list-style-type: none"> • Provides services without the need for user ownership – virtually risk-free for users • Small payments improving the users’ cashflows and credit history (particularly with mobile money) • Often includes presence of experienced staff who operate the WICR • Incentivises high efficiency and performance 	<ul style="list-style-type: none"> • Substantial amount of capital financing required of the WICR operator (i.e. longer repayment period) • Variable (and potentially unpredictable) income for the WICR operator, who relies on a regular customer base • Increased likelihood of fresh produce mixing in the WICR to increase the utilisation rate – requires training on how to store mixed produce within the same chamber • Clients might start negotiating the daily storage price – the WICR operator must have strict guidelines to ensure a profitable business • Running the operations without digital tools can be a challenge regarding storage optimisation and business scale-up

Business model	Brief description	Delivery model	Advantages	Challenges
Aggregator model	Farmers sell produce to the aggregator; cooling and market linkages managed by the aggregator	Service-based	<ul style="list-style-type: none"> • Farmers only focus on growing and harvesting without the need to interact with cooling and market linkages • Stable, pre-agreed price per kilogram of produce • Instant payment to farmers for their produce 	<ul style="list-style-type: none"> • Aggregators take on risks and diverse responsibilities, including WICR operations and market linkages • Substantial amount of capital required (i.e., longer repayment period), in addition to market knowledge and specialised skills • If mono-crop storage: highly dependent on seasonal market prices (i.e., exposure to market risks for the aggregator) • If multi-crop storage: requires training for the aggregator on how to store mixed produce within the same chamber • Running the operations without digital tools can be a challenge regarding storage optimisation and business scale-up
Lease-to-own model	WICR repaid over time; individual or shared use (in which case it is often combined with other models in this table)	Full ownership	<ul style="list-style-type: none"> • Increased income and value added to existing entrepreneurs or cooperatives • Improved quality and access to premium markets for the entrepreneur or cooperative • Capital required of the entrepreneur or cooperative to cover the deposit but significantly less than the overall upfront cost (usually around 15%) 	<ul style="list-style-type: none"> • Operations and basic maintenance are carried out by the entrepreneur or cooperative member • Risk of stranded asset sits with the entrepreneur or cooperative • Limited number of users who can achieve high utilisation rate on their own • Less incentive for the WICR supplier to focus on high efficiency and performance since they are not involved in the operations

Business model	Brief description	Delivery model	Advantages	Challenges
Upfront payment model	WICR is paid in full upon commissioning	Full ownership	<ul style="list-style-type: none"> • Short working capital cycle requirements for the WICR supplier • Little default or currency devaluation risks 	<ul style="list-style-type: none"> • Requires significant savings or access to finance from external sources • Low affordability for smallholder farmers and marketplace vendors • Limited addressable market • Technology and profitability risks sit with the WICR operator • Less incentive for the WICR supplier to focus on high efficiency and performance since they are not involved in the operations
Mobile services model	WICR regularly moving (i.e. on a daily or weekly basis) to buy and sell produce	Service-based	<ul style="list-style-type: none"> • High utilisation rate potential by moving closer to the customers • Can use the same cold room for storage and transport to markets • Potential for a wide geographical cover 	<ul style="list-style-type: none"> • Requires good road infrastructure • WICR unlikely to be fully solar-powered

3.7.4 The role of service-based models in walk-in cold room development and operations

Service-based models – namely rental, pay-as-you-store, aggregator, and mobile services models – are likely to play an important role in the widespread adoption of WICRs. They can address challenges associated with the high upfront cost of WICRs, limited access to finance for individual users, cooperatives and even enterprises, and competing priorities of governments preventing a rapid deployment rural cold chain infrastructure in the near future. Even if WICR operators can pay for the WICR upfront or secure a lease-to-own contract, most of them are likely to adopt service-based models to generate income from the WICR users. Adopting a sustainable pricing strategy that balances affordability for WICR users with the financial viability of the business is key for the long-term success of service-based models where end-users interact directly with the WICR (i.e., not the aggregator model where the operator is the user as well). The key advantages of service-based models are the following:

- **Reducing access to cooling barrier:** Customers only pay for the use of the service rather than purchasing and owning the equipment.
- **Building credit history:** Individual customers, such as smallholder farmers or marketplace vendors, can build credit history from their payments, which can in turn facilitate end-users’ access to finance from other lenders in the future.

- **Displacing diesel generators:** By shifting the asset ownership to the solution provider, service-based models bring incentives for the cooling service provider to keep operational costs to a minimum (i.e., using solar energy). This can be part of climate mitigation strategies, reducing the use of diesel generators and dependency on fossil fuels, possibly generating carbon credits (see Section 3.8 for further details), and yielding a more sustainable economic model.
- **Increasing energy efficiency:** As customers pay a fixed fee per service delivered, the more efficient the provider is, the higher their respective profit margin and market competitiveness are. Hence, the model promotes more economical solutions, such as encouraging the provider to use thermal storage rather than batteries only.
- **Reducing environmental impacts:** Service-based models enable companies to transfer reusable components to other WICRs or re-deploy entire systems to different locations based on demand. This in turn reduces the amount of e-waste, associated particularly with batteries and solar PV panels. The WICR owners are incentivised to optimise efficiency and reduce the maintenance costs, including the reduction of refrigerant leakage. Climate Finance Lab⁸ estimates that cooling-as-a-service can reduce emissions from electricity use and refrigerant leakage by up to 49%.
- **Optimising maintenance cycles:** Service-based models motivate companies to design components for long-term use that can be easily repaired, further increasing the profitability of the solution while delivering reliable cooling service to the WICR users. Manufacturers are therefore encouraged to design WICRs for optimised maintenance cycles to reduce the operations and maintenance costs.
- **Increasing utilisation rates:** Service-based models encourage the WICR operators to find strategic locations, which can achieve high utilisation rates. This approach incentivises WICR operators to make the most of the existing assets, while yielding a reasonable return on investment.

Although WICR service-based models deployed in rural areas have a lot of potential, they have not been proven at scale to date. Some of the key barriers are as follows:

- **Securing access to finance:** Companies offering service-based models need substantial capital to invest in the WICRs and recuperate the initial cost over time. Depending on the pricing strategy and the utilisation rate, this can take several years to achieve, which requires access to patient capital. The topic of WICR financing is further explored in Section 3.8.
- **Dealing with multiplied risks:** Most risks sit with the WICR operator when it comes to service-based models. There are various risks associated with the WICR operations, including asset malfunction, lower utilisation rate than anticipated, crop failure, end-users' fluctuating ability to pay, climate disasters, macroeconomic and market changes, and more. Some of these risks can be mitigated through contractual agreements or insurance but only if a robust risk management plan is developed from the outset.
- **Providing capacity building and training:** Service-based models rely on qualified workforce to operate, maintain and use the cold room effectively and safely. Owners of multiple WICRs need to establish a network of operators and technicians to provide reliable cooling service to their customers.
- **Being mindful of cultural norms:** The concept of not owning the product (in this case, a WICR) and paying someone for their services indefinitely can have adverse effects on the uptake. In certain contexts, asset ownership is strongly desirable, which WICR operators need to deal with through awareness raising campaigns and other customer-facing initiatives.

⁸ Cooling as a Service. Global Innovation Lab for Climate Finance. <https://www.climatefinancelab.org/ideas/cooling-as-a-service-caas>

- **Using digital tools:** Many WICR operators run their service-based models without using advanced digital tools which prevents them from tracking performance, better analysing customer data, optimising operating expenditure and providing valuable transparent data to financiers willing to invest in their business. The digital tools can include software for the WICR operators to optimise operations and collect payments as well as digital services for the customers, enabling them to remotely monitor the quality of their produce and build credit history.

3.7.5 Six main business models with examples

This section briefly introduces six main business models that are applicable in adding value to the agricultural produce, supporting low income and smallholder farmers and other vendors, accelerating the deployment of solar-powered WICR technology and minimising stranded assets.

Rental model:

In this model, the company operating the WICR leases or rents out the cold room space to customers who need cold storage facilities. The customers pay a monthly or seasonal fee to use the WICR, which covers ongoing maintenance and operational costs as well as investments costs and profit. This model can be particularly beneficial for smallholder and low income farmers who rely on a specific value chain for income generation but cannot afford to invest in their own cold storage infrastructure. The WICR operator can either rent out the space in the cold room to more users (e.g. smallholder farmers or marketplace vendors), or rent the entire unit to larger customers (e.g. agri-businesses or cooperatives).

CASE STUDY: RENTAL MODEL

FreshBox is a Kenyan WICR company that offers their customers to sign up to the rental model based on a fixed monthly fee, amongst other options⁹. Their target customers are smallholder farmers, farm produce organisations, retailers and marketplace vendors, with key value chains, including fruit and vegetables, and, more recently, dairy, meat and fish. FreshBox is shifting away from the pay-as-you-store model due to the number of contracts and challenges associated with daily revenue collection from many individual customers. The rental model allows FreshBox to contract a smaller number of larger customers and charge them monthly.

FreshBox offers customers three different products: monthly payment of USD 300 for 20 crates of produce (0.5-tonne WICR), monthly payment of USD 450 for 50 crates of produce (1.5-tonne WICR), or monthly payment of USD 550 for 100 crates of produce (3-tonne WICR). Although the rental model is slowly growing as part of FreshBox's offering, it is still a nascent and unproven business model since 55% of their customers have lease-to-own contracts over a period of 12 months and 30% of customers purchase the WICR upfront (Efficiency for Access, 2023b). These prevalent models enable FreshBox to sell WICRs to larger customers and recover costs quickly, while avoiding the need to manage the day-to-day operations of the asset.

Pay-as-you-store model:

As with the rental model, the WICR operator offering the pay-as-you-store model charges customers for using the WICR without the need for owning it. However, the payment is based on their actual use of the space rather than paying a monthly or seasonal rent (e.g. to sell produce in town markets). In the pay-as-you-store model, also referred to as cooling-as-a-service, customers can access cooling on a 'pay-per-use' basis by buying the service instead of paying upfront investments for the equipment. The pay-as-you-store model for WICR is equivalent to the servitisation concept – a business model where a product is replaced by a service – which has been gaining traction across various sectors from urban transport to printing.

⁹ Global Leap Awards Spotlight: Freshbox, the solutions provider. <https://medium.com/efficiency-for-access/freshbox-the-solutions-provider-ab0255576432>

The service provider keeps ownership of the assets and is responsible for operating, maintaining, and repairing the WICR in exchange for the fees from the customer contractually agreed upfront. Customers are billed accordingly, which incentivises them to use the WICR space efficiently and sell the produce as soon as they find a buyer. From an operator perspective, the pay-as-you-store model also encourages them to implement best practices even if it requires higher investment costs to keep the WICR users satisfied with the cooling service.

CASE STUDY: PAY-AS-YOU-STORE MODEL

ColdHubs¹⁰ is a Nigerian company offering farmers a flexible pay-as-you-store model. The company provides access to cold storage for smallholder farmers and marketplace vendors who pay a daily flat fee of 200 Nigerian Naira (equivalent of USD 0.26, August 2023) to store one 20 kg (44 lbs) returnable plastic crate per day inside the cold room on dedicated shelves. Their customers can renew the payment on a daily basis. The WICRs are operated by a woman Hub Operator, who monitors the loading and unloading of crates and collects the fees (currently in cash but digital payments may become available in the future), and a Market Attendant, who builds relationships with farmers and marketplace vendors. ColdHubs owns all the equipment with the assets on their own balance sheet, removing this barrier for small-scale operators who cannot afford the upfront investment¹¹.

The WICRs are located in farm clusters, produce aggregation centres, and outdoor markets to maximise the utilisation rate but also to reach new customers who see other farmers storing and preserve fresh fruits, vegetables, and other perishable foods, extending their shelf life from two days to more than 21 days. The pay-as-you-store model enabled ColdHubs to reach 6,317 farmers, retailers, and wholesalers through improved household income (~50%), improve food security and health outcomes, and create local employment including 48 new jobs for women. They have enhanced the penetration of clean technologies, saved close to 2.5 million tonnes of CO_{2e}, and reduced poverty and the dependence on diesel generators from inaccessible or unreliable grids¹². ColdHubs is part of the global Servitisation for Energy Transition Alliance Community of Practice¹³, which brings together WICR operators from different geographies to share best practices and lessons learned on the cooling-as-a-service business model.



Figure 3.13

ColdHubs walk-in cold room (photo: ColdHubs).

¹⁰ <https://www.coldhubs.com>

¹¹ *Cooling as a Service Case Study: CaaS Prize Winner ColdHubs Improves Cold Storage Access in Nigeria.* https://www.caas-initiative.org/wp-content/uploads/2020/08/200828_ColdHubs-2.pdf

¹² *How Coldhubs won 2020 global CaaS prize.* <https://www.coldhubs.com/coldhubnews/2020/9/9/how-coldhubs-won-2020-global-caas-prize>

¹³ *BASE launches the servitisation for energy transition alliance.* <https://energy-base.org/news/base-launches-the-servitisation-for-energy-transition-alliance>

Aggregator model:

In this model, the WICR operator buys produce from various smallholder farmers and sells it in bulk for higher prices. The benefit is that the aggregator can buy produce from smallholder farmers, who often struggle to find a buyer, aggregate over a period of days or weeks by using the WICR, and then supply much larger orders consistently to larger market players (e.g., supermarkets) to attract premium prices. In addition to operating the WICR, the aggregator can offer value-added services, such as sorting, grading and packaging or the provision of advisory services on postharvest handling and food preservation techniques. These additional services can attract more customers and create a diversified revenue stream.

CASE STUDY: AGGREGATOR MODEL

SokoFresh¹⁴ is a Kenyan social enterprise which focuses on reducing postharvest losses through off-grid cooling and market linkages. SokoFresh operates cooling hubs in rural areas where participating smallholder farmers can aggregate their horticulture produce. SokoFresh uses the aggregator model mainly for avocados, mangoes, and bananas but also other value chains such as limes or pineapples across various locations in Kenya including one of their first pilots in Embu (Food Flow, 2022). In Embu, SokoFresh buys avocados directly from farmers and pays them a consistent, above market price per kg, which enables the farmers to increase their income by 20-40% compared to the price they got paid by intermediaries in the past¹⁵ (Food Flow, 2022)¹⁶. Payments are made instantly through a platform called DigiFarm¹⁷, which is a major selling point for farmers. SokoFresh stores the avocados in the WICR and sells them to off-takers for export.

The key advantage of SokoFresh's business model is the ability to move the containerised WICRs between different locations to increase the utilisation rate based on the value chain(s) seasonality¹⁸. This approach would be more challenging with rental or pay-as-you-store models but with the aggregator model, SokoFresh can easily establish new relationships with a new set of farmers by paying them instantly for the produce.

In addition to buying avocados from the farmers, SokoFresh provides advisory services such as improved harvesting techniques and careful postharvest handling. This holistic approach enables farmers (and ultimately SokoFresh) to make more income, while reducing the amount of produce decomposition on the farm which has significant impact on greenhouse gas emissions due to the production of methane. With this model, SokoFresh avoids nearly all postharvest losses, from up to 50% losses across the average fruit and vegetable value chains in Kenya. By the end of 2022, SokoFresh reached 8,000 farmers, deployed 14 WICRs from Ecozen, stored 2,141 tonnes of produce and avoided 27 tonnes of CO_{2e} per year (Food Flow, 2022).



Figure 3.14

SokoFresh walk-in cold room¹⁹.

¹⁴ <https://sokofresh.co.ke>

¹⁵ From pilot to scale – how SokoFresh is making cold-storage more accessible for thousands of low-income farmers. <https://www.preo.org/from-pilot-to-scale-how-sokofresh-is-making-cold-storage-more-accessible-for-thousands-of-low-income-farmers>

¹⁶ The income increase range was validated through an email correspondence with SokoFresh in September 2023

¹⁷ <https://digifarm.io>

¹⁸ Off-grid cold storage for farmers in Kenya. https://www.caas-initiative.org/wp-content/uploads/2022/04/Case-Study-Sokofresh_April6.pdf

¹⁹ Cooling Services for Stable Income and Food Security <https://we4f.org/ea-rih/modular-refrigerated-containers-secure-income-and-food-security>

Lease-to-own model:

In the lease-to-own model, local entrepreneurs or agricultural cooperatives purchase the WICR room over time and use it for their own produce. They become responsible for operations and basic maintenance of the facility themselves. More substantial maintenance may need to be outsourced to experienced technicians. This approach is suitable for wealthier farmers, larger agricultural enterprises or cooperatives that have sufficient resources and knowledge to operate the WICR and grow enough produce to fill the cold room on their own, or work with extension schemes. Most entrepreneurs or cooperatives require enough capital or access to finance to cover the deposit which is often part of the lease-to-own contract. For example, InspiraFarms²⁰ offer lease-to-own contracts to eligible companies with a tenor of one to five years but require at least 15% deposit of the total invoice value.

One of the key risks for developers who offer lease-to-own contracts is a payment-default risk. This can be mitigated through contractual clauses, reallocating the equipment or interrupting the provision of cooling through remote monitoring, and the use of payment guarantees when available and applicable. Another important way of mitigating the payment-default risk is conducting proper due diligence and carefully selecting the first WICR clients, to build a successful track record. To diversify the systemic risks such as global pandemics, climate hazards, or economic crises, it is crucial to diversify the customer portfolio with respect to value chains and geography. In addition, the WICR operator needs to achieve high utilisation rates of their assets to yield an adequate return on investment.

CASE STUDY: LEASE-TO-OWN MODEL

Jungle Harvest is a Kenyan business that grows organic herbs for export to Europe and the Middle East. The 0.75-acre farm is based near Thika in a lush location with access to a small river. The farm employs up to 10 local people, predominantly young single mothers. The farm has gone through various iterations over the past two decades with the herbs business becoming the most successful endeavour. Jungle Harvest grows a wide range of herbs (mostly in dedicated greenhouses) including basil, coriander, mint, rosemary, sage, tarragon, and thyme²¹. Jungle Harvest purchased the WICR from Solar Cooling Engineering, which won the Global LEAP Off-Grid Cold Chain Challenge in 2022 for the best performing direct current walk-in cold room on the market. Although this particular WICR was subsidised through a grant, Jungle Harvest paid a small deposit and seven instalment payments, which is aligned with the lease-to-own model principle. Since acquiring the WICR, Jungle Harvest significantly increased their herbs production output, which enabled them to nearly double their income by accessing higher value export clients. To increase the utilisation rate during low season, Jungle Harvest buys vegetables in bulk and stores them in the WICR, before distributing them locally to earn extra income. Jungle Harvest is planning to use the additional income to lease land from their neighbours to grow more herbs, effectively doubling the farm size to nearly two acres.

The use of the WICR improved the quality of herbs that Jungle Harvest sells²². Prior to purchasing the WICR, Jungle Harvest paid for a truck service twice a week to transport the herbs from the farm to the airport. Due to the lack of access to cooling, the herbs lost their freshness between harvest and the pick-up. The herbs are now harvested early in the morning, processed in shade, and stored in the WICR. The refrigerated herbs are transported from the farm less frequently than before, which reduces the cost of transport while keeping the herbs fresh. Although using a WICR by a single smallholder farmer is rare, this example demonstrates that it can be done for premium products in certain contexts.

²⁰ <https://www.inspirafarms.com/financing>

²¹ *Locally grown herbs for global markets: how a Kenyan agribusiness is thriving on off-grid cold storage.* <https://medium.com/efficiency-for-access/locally-grown-herbs-for-global-markets-how-a-kenyan-agribusiness-is-thriving-on-off-grid-cold-82ad4efef649>

²² Source: Interview with Jungle Harvest in May 2022.



Figure 3.15

Solar Cooling Engineering walk-in cold room and basil production in Thika, Kenya (Efficiency for Access, 2022).

Upfront payment model:

Upfront payment is the most conventional business model, which leads to short working capital cycles for WICR suppliers. WICR suppliers typically require down payment when the order is placed, with the remaining amount being paid upon commissioning (payments can also be made in tranches depending on the contract). The main challenge with the upfront payment model is that the addressable market is relatively limited. Some customers may have enough capital to pay upfront, especially when it comes to large agricultural companies or projects that are funded via grants, but most customers, including local entrepreneurs, cooperatives and aggregators, are unlikely to have sufficient capital to pay upfront.

Mobile services model:

Offering mobile cold room services is an emerging concept where a small WICR is mounted on trucks or trailers, allowing them to be transported to different locations based on demand. This model can be particularly useful for serving remote or seasonal farming areas, as well as temporary food storage needs for days or weeks (e.g., to cover short-term peak supply at farm-gate or peak demand at markets). This model is common in urban areas to distribute refrigerated produce to customers but its use in rural settings is relatively new. Although the mobile services model has the potential to serve rural communities, this guide is primarily focused on stationary WICRs. Therefore, it is not further explored in this guide, but you can read further details about this business model through the Koel Fresh case study²³. Koel Fresh fabricates their mobile cold room with an insulated chamber, thermal storage system, and solar PV to connect horticulture farmers with customers in Rourkela, India. Mobile services can also be useful for precooling of fruit and vegetables before they are transported to larger storage facilities, which are often lacking in rural areas (Global Knowledge Initiative, 2017).

²³ Renewable energy powered cold-storage systems. <https://www.koelfresh.com/re-powered-cold-storage-systems/page-41026820>

3.8 Financing

3.8.1 Overview of the main walk-in cold room financing options

The importance of identifying and securing a fit-for-purpose financing option for WICR developers at the outset of project development cannot be overstated. It is one of the most important considerations to unlock a wide deployment of WICRs in the Global South. Many developers have been able to secure grant funding for a pilot WICR but only a small number of WICR companies have been able to secure larger commercial investment to scale up. It will require a significant shift in the financing landscape for market transformation since many commercial investors still find WICR business models too risky. For example, if a developer is to deploy 100 WICRs, they could require at least USD 3 million to meet their financing needs and repay the lender over the agreed period, which is likely to be considerably longer than financing smaller products such as off-grid solar lights, televisions, or productive use appliances such as solar irrigation systems or refrigerators.

In addition to the cost of working capital, developers who do not sell WICRs upfront will need to cover foreign exchange risks, default and late payment risks, costs associated with payments collection as well as transaction and other costs associated with asset financing as outlined in the Efficiency for Access Road to Zero Interest report (Efficiency for Access 2023c).

Different types of WICR developers will have different financing needs. For example, developers who sell their WICRs upfront will seek debt financing with relatively short tenor to meet their short working capital cycles. On the other hand, companies who offer service-based models will generally seek to finance fixed assets that remain on their balance sheet with equity, rather than debt, or secure lease-to-own contracts with the WICR supplier.

The off-grid solar WICR sector in the Global South is still emerging, which is also reflected in the financing options that are available to WICR developers today. The vast majority of WICRs deployed to date have been supported through grants or leveraged blended finance instruments to de-risk investment for the private sector. Although the sector needs to tap into fully commercial financing, grants and blended finance instruments will play a catalytic role, especially in the next five years until the technology and business models are proven to be fully commercially viable.

The main financing options for WICR developers are as follows (listed as most common to most speculative):

- Grants and other subsidies
- Blended finance instruments (typically offering a combination of grants, equity and/or debt)
- Equity
- Debt (i.e. loan to be repaid to the lender)
- Public-Private Partnership
- Carbon credits (not available for WICRs in 2023 but could become an option in the future)

Guiding questions to navigate the financing landscape:

- What is the required length to bridge the financing gap between procurement and full repayment (also referred to as the working capital cycle)?
- How much financing is required for your project or project portfolio and what is the breakdown between capital expenditure (CAPEX) and operating expenditure (OPEX)?

- What is the cost of servicing your source of finance and how does that align with your anticipated revenue or capacity to satisfy reporting requirements (in the case of public funds)?
- Are there any existing or potential partners to increase the ticket size of your project or portfolio?
- Who are your existing and potential finance providers? What are their risk profile and return on investment expectations?
- Are there any government, donor or philanthropic grant funding opportunities or other subsidies that you are eligible to apply for?
- How does the financing option align with your long-term strategy?
- What is your anticipated period to break even and repay the CAPEX costs of your WICR?

3.8.2 Summary of the main financing types for walk-in cold rooms

Grants and other subsidies:

Grant funding has been the most prominent financing pillar of the off-grid solar WICR deployment to date. Grants provided to WICR developers often target technology or business model innovation. In addition to upfront grants, there are other public funding mechanisms that could be applied to WICRs including results-based financing (RBF). The Designing Public Funding Mechanisms in the Off-Grid Solar Sector report by ESMAP²⁴ provides a deep dive into the topic of supply-side and demand-side funding mechanisms.

Most off-grid solar WICR grant funding has come from the Efficiency for Access Research & Development Fund²⁵, Powering Renewable Energy Technologies²⁶ and EEP Africa²⁷, whereas RBF is at the core of the Productive Use Appliance Financing Facility²⁸. WICR developers should monitor grant funding and RBF opportunities on a regular basis to identify relevant funding opportunities.

Blended finance:

Blended finance is a tool to mobilise private capital to de-risk investment into sustainable development projects or companies²⁹. It combines concessional financing from development finance institutions and/or philanthropic funds with commercial funding from private investors³⁰. Blended finance allows investors to choose different risk tolerances while participating in the same investment round³¹. The catalytic role of blended finance in the off-grid solar sector is further described in SunFunder's Scaling Energy Access with Blended Finance report³². Blended finance underpinned some major WICR investments already – equity investments have been secured by InspiraFarms from KawiSafi³³ and SokoFresh from Acumen³⁴.

²⁴ *Designing public funding mechanisms in the off-grid solar sector.* <https://documents1.worldbank.org/curated/en/0993300005162263450/pdf/P17515006776e102308e980bb2d798ca5c3.pdf>

²⁵ <https://efficiencyforaccess.org/grants>

²⁶ <https://www.preo.org/grant-funding>

²⁷ <https://eepafrica.org>

²⁸ *Innovative financing facility supports 18 productive use companies in Africa.* <https://www.clasp.ngo/updates/innovative-financing-facility-supports-18-african-companies>

²⁹ <https://www.oecd.org/development/financing-sustainable-development/blended-finance-principles>

³⁰ *What is blended finance, and how can it help deliver successful high-impact, high-risk projects?* <https://ieg.worldbank-group.org/blog/what-blended-finance-and-how-can-it-help-deliver-successful-high-impact-high-risk-projects>

³¹ *What is blended finance, and why it matters.* <https://about.bankofamerica.com/en/making-an-impact/blended-finance>

³² *SunFunder shares lessons on blended finance in white paper.* <https://www.sunfunder.com/post/sunfunder-shares-lessons-on-blended-finance-in-white-paper>

³³ <https://www.kawisafi.com/portfolio/inspirafarms>

³⁴ *New investment: SokoFresh reduces post-harvest losses for farmers.* <https://acumen.org/blog/sokofresh-reduces-post-harvest-losses-for-farmers>

Equity:

Larger equity investments will become an increasingly important financing option for WICR developers as the sector matures. The initial investment through a seed round is typically covered through founders' savings, support from family and relatives, or angel investors. The seed round is then followed by Series A, B and C, which include higher ticket sizes in each round. There is only one off-grid solar WICR company that reached Series C to date – Ecozen who secured USD 25 million in Series C in 2023³⁵.

The company journey is often defined by equity investment opportunities and ticket sizes. There is no one-size-fits-all solution, but all equity investors look for return on their investment. Some investors may be willing to invest in riskier ventures or younger companies with less track record, seeking positive social and environmental impacts. Although impact investors may provide patient capital with longer exit runway or have lower return on investment expectations, WICR developers still need to demonstrate a clear pathway to profitability to secure equity investment.

Debt:

Debt financing involves borrowing funds in the form of a loan, usually from commercial banks or other debt providers, and paying it back with interest. However, due to the risks (perceived and real) and uncertainties involved in investing in innovative technologies including WICRs and relatively unproven business models, commercial banks are often conservative and reluctant to provide debt financing for WICRs or propose high interest rates, to cover for the risk. Therefore, debt is more likely to come from international investors, or debt providers with expertise in energy access, in the short term – given their higher risk appetite and greater experience in related sectors.

The lack of debt financing from commercial banks could be overcome by asset-backed financing models such as sale-leaseback. Sale-leaseback³⁶ is a hybrid debt product in which the company that sells an asset can lease back that same asset from the purchaser to improve their balance sheet health, which can be useful for large expensive equipment such as WICRs. Setting up a special purpose vehicle allows multiple assets to be bundled, which in turn increases the ticket sizes of the investments and diversifies the risks. This can also reduce the costs of lending and de-risk investments. Organisations like BASE³⁷ are actively working to increase banks' interest in funding service-based cooling opportunities as it is vital to unlock commercial debt to scale up the adoption of WICRs.

Another way to overcome the lack of debt financing from commercial banks is the use of off-balance sheet financing, which is gaining traction across the off-grid solar sector³⁸. Off-balance sheet financing is an accounting practice to keep the debt-to-equity ratio low, which is important for most debt providers. In 2022, d.light and Frontier Capital announced a USD 238 million multi-currency debt facility – the largest off-balance sheet facility in the off-grid solar sector³⁹. It should be noted that an off-balance sheet facility needs to be in the tens of millions of US dollars to justify transaction costs, which is why there has been no equivalent facility focused on WICRs to date.

³⁵ Agri-focused cleantech Ecozen closes \$25 million in new funding round. <https://economictimes.indiatimes.com/tech/funding/agri-focussed-cleantech-ecozen-closes-25-million-in-series-c-round/articleshow/97277383.cms?from=mdr>

³⁶ <https://www.investopedia.com/terms/l/leaseback.asp>

³⁷ <https://energy-base.org>

³⁸ CAP Financial Innovation Challenge. A platform for scaling up off-balance sheet receivables financing for off-grid solar. <https://www.undp.org/climate-aggregation-platform/platform-scaling-balance-sheet-receivables-financing-grid-solar>

³⁹ D.light and SFC announce industry-leading USD 238 million multi-currency receivable financing Facility. <https://www.dlight.com/wp-content/uploads/BLK2-Press-Release-14-June-2022.pdf>

Public-Private Partnership:

There is no standardised definition of a Public-Private Partnership (PPP) but it typically involves a long-term contract between the government and a private company to provide public goods and services⁴⁰. In the PPP, governments partner with WICR companies to establish and operate cold rooms in areas with a critical need for cold chain infrastructure. PPP leverages the expertise of the private sector while ensuring access to essential services for the public. PPP often includes bulk procurement which can benefit from economies of scale, and therefore results in lower cost per WICR unit deployed. This model could improve food security and better nutrition amongst local communities who are unable to pay the full price for refrigerated fresh produce. There are very limited examples of the PPP model for WICRs deployed to date, although it may become more common as governments progress towards implementing their national cooling action plans as highlighted in Section 3.7.1.

The most notable examples of PPP in WICR infrastructure development have been pursued by the Government of India⁴¹, although mostly related to significantly larger projects rather than standalone solar WICRs. The success of cold chain within the smallholder dairy sector in India is a prime example of what PPP can achieve when deployed at scale⁴².

Carbon credits:

Monetising carbon credits could potentially play an important role in co-financing WICR developers' portfolio in the future. By adopting solar-powered, energy-efficient technologies and sustainable practices, WICR operators could earn carbon credits through the avoidance of greenhouse gas emissions. These credits could then be, in theory, traded or sold on the Voluntary Carbon Market⁴³. Carbon credits are commonly used for off-grid solar technologies such as lighting⁴⁴ and cooking⁴⁵, and recently piloted for refrigerators⁴⁶.

The calculation of carbon credits from the use of solar-powered WICRs could either be based on the replacement of diesel generators and/or avoidance of food waste. The latter is particularly compelling due to the high greenhouse gas emission avoidance potential (Efficiency for Access, 2023d) but further research is required to develop robust carbon credit accounting methodology. It should be noted that despite the growing interest, there have been no examples of carbon credits associated with WICRs to date.

3.9 Outline technical specification

This section summarises elements of an initial outline technical specification that should be drawn up in the planning process to ensure clear understanding of the requirements and focused discussion with potential suppliers and partners. These issues are discussed in this part and in more detail in the respective other parts of this guide as indicated in Table 3.2:

⁴⁰ About PPPLRC and PPPs. <https://ppp.worldbank.org/public-private-partnership/about-us/about-public-private-partnerships>

⁴¹ https://nhb.gov.in/online_application_nhb_scheme_2020_21.aspx?enc=3Z0O8K5CzcdC/Yq6HcdlxFfgWqd9Zpsh5GgGF2IJ/Sbjhzna+ksD2hsqVFnQhiDh

⁴² Dodla Dairy, Twiga Foods and Babban Gona: Three model farmer-allied intermediaries. <https://www.bain.com/insights/dodla-dairy-twiga-foods-and-babban-gona-three-model-farmer-allied-intermediaries>

⁴³ What is the Voluntary Carbon Market? <https://carboncredits.com/what-is-the-voluntary-carbon-market>

⁴⁴ <https://namenensolar.com/carbon-credits>

⁴⁵ Carbon credits, High integrity carbon offsets for people and planet. <https://mecs.org.uk/publications/the-role-of-voluntary-carbon-markets-in-clean-cooking>

⁴⁶ Promoting Sustainable Energy Access through Innovative Financing Models: Koolboks Pay-as-You-Go Freezer and Carbon Financing <https://www.thefuturelist.com/promoting-sustainable-energy-access-through-innovative-financing-models-koolboks-pay-as-you-go-freezer-and-carbon-financing>

Table 3.2

Summary technical specification elements for a walk-in cold room project, including site status, requirements and performance, with links to sections of the guide for full details.

Topic	Specification element	Examples of indicative key considerations (others will apply as well or instead, depending on the situation and needs)	Further details see section
Legal compliance framework	Local regulations and requirements	<ul style="list-style-type: none"> • Which are the national and local authority/authorities responsible for compliance issues for the locality? • Which mandatory standards and legal frameworks will apply to the type of building, its equipment and its site? And what are the implications? • What voluntary standards or other requirements are planned to be applied? And what are the implications? 	
Site	Where will the cold room be located (address, location)?	<ul style="list-style-type: none"> • Country, region, GPS coordinates (or latitude/longitude), elevation. 	3.5
	Place of installation	<ul style="list-style-type: none"> • Open air; inside another building (describe); proximity to other features (with indicative height and type if close by) buildings, natural features, trees; drainage in place. • Does the cold room need to be moved at some later time (e.g. if the cold room operators do not own the land it is located on)? 	3.5
	Nature of surface on which WICR will stand	<ul style="list-style-type: none"> • Material of the surface, outer dimensions and shape, how flat and level surface is, preparation work already done; preparation known to be required before installation. E.g., Levelled concrete floor; unsurfaced dirt hard packed. 	6.1.3
	Shading (for solar PV and heat gain)	<ul style="list-style-type: none"> • Is the site unshaded 8AM-4PM? • If shaded, describe causes of shading (source of shade; direction from WICR (bearing); proximity; height; size). • Note if solar modules could be/will be separately located (distance to WICR); if tree or plant shading is a risk to be controlled before installation. 	5.4.1
	Any special characteristics of the site with brief importance	<ul style="list-style-type: none"> • For example: site microclimate, windstorm risk, dust risk (for solar modules), seismic activity, marine environment (salt spray), need for extra security/ theft deterrence, etc. 	-
	Ambient temperatures throughout the year	<ul style="list-style-type: none"> • Ambient temperatures determine the system performance. 	4.4
	Solar radiation profile for the site		5.4.1.4
Infrastructure at the site	Grid (or mini-grid) electricity; off-grid	<ul style="list-style-type: none"> • Is supply considered: reliable/limited/unreliable/off-grid? • Indication of supply quality: any reports of outage frequency and duration; SAIFI and SAIDI indices; hours per day ‘guaranteed’; for public grid: quality benchmark such as IEC TS 62749 or EN 50160; for mini-grid: if supply meets NREL quality assurance framework (base / standard or high). • Is there an off-peak rate price structure (specify rates, times)? 	5.2

Topic	Specification element	Examples of indicative key considerations (others will apply as well or instead, depending on the situation and needs)	Further details see section
	Road access to site for delivery of cold room and equipment	<ul style="list-style-type: none"> Ease of access, quality of road surfaces, any height or weight restrictions on site and along the route 	3.5, 6.1.2
	Logistical access to site for produce when in operation	<ul style="list-style-type: none"> Ease of access, proximity to producers, markets, customers 	3.5, 3.7.2
Business and operational plan (only aspects that directly impact technical design)	Role of the cold room and usage	<ul style="list-style-type: none"> Short/medium/long term storage (hours/weeks/months) Single/dual vs. multiple types of produce stored Shared/public use vs. accessed by own staff Community asset/commercial venture Need for versatility, expansion, flexibility of internal arrangements 	3.7
	Evolution of needs	<ul style="list-style-type: none"> Is the use of the cold room likely to change in the future and does there need to be extra capacity to cope with changes? 	4.3.3
Cooling needs	Purpose of cooling	<ul style="list-style-type: none"> Is the system used for precooling, storage cooling, or both? This is extremely important for determining the system cooling capacity. Is change of cooling needs likely within a year or few years, and so how important is flexibility, modularity, ease of reconfiguration? 	2.3.2 4.3.3 4.3.4
	Estimate of precooling needs	<ul style="list-style-type: none"> What are the indicative quantities of throughput and produce types, temperatures at start and end of chilling? 	4.3.4, 4.4
	Product(s) to be cooled	<ul style="list-style-type: none"> What is known of the likely produce to be cooled? How will this vary by season? What are likely product compatibility requirements/risks? What is their average storage time, stock turnover? 	2.3.6 2.3.8 4.3.5
	Cooling temperature range	<ul style="list-style-type: none"> What is the temperature range of set points required for cooling the products? (This guide only covers chilled storage, not frozen storage) What level of temperature fluctuation is acceptable? Note that three generic temperature ranges/storage conditions are generally used. 	2.2.1 2.3.1 2.3.6
	Relative humidity during storage	<ul style="list-style-type: none"> Is humidity control needed, and if so to what range during storage? 	2.2.3 2.3.3 2.3.6
	Indication of the 'Design Day' cooling load for which the system is to be designed	<ul style="list-style-type: none"> How is the cold storage to be used throughout the year/week/day? How much product will be loaded into the cold storage per day? Before deciding the 'Design Day' loading conditions, consideration is needed of the 'Typical Day' and 'Peak Day' conditions, balanced against likely available budget (unlikely to be economically viable to design a system entirely for meeting Peak Day conditions). 	4.4

Topic	Specification element	Examples of indicative key considerations (others will apply as well or instead, depending on the situation and needs)	Further details see section
Cold room characteristics	System type	<ul style="list-style-type: none"> Pre-assembled, containerised (20' or 40', etc.), kit, custom-made, etc. 	3.4
	Size/inner volume of the WICR	<ul style="list-style-type: none"> Volume in cubic metres; floor area; shape Capacity in tonnes of produce Any limitations of outer dimensions (avoiding nearby features, etc.) Could a smaller size be tolerated, if the business case is marginal for economic viability? 	3.4.6
	System control	<ul style="list-style-type: none"> What is the indicative nature of control system needed? Which set parameters (temperature, humidity, air flow), on-site and/or remote operation and monitoring, alarms or automated cooling functions? 	2.3, 4.10
	Performance monitoring	<ul style="list-style-type: none"> How will cold room performance be monitored? And performance of the business operations (stock turnover, income, profitability, etc.)? 	4.10, 7.8
	Requirements of the refrigerant and insulation foam blowing agent	<ul style="list-style-type: none"> Refrigerants with a low global warming potential (< 150) should be the default choice though this is a complex and important decision in terms of environment, safety and efficiency – see 4.8. 	4.8
	Environmental and sustainability	<ul style="list-style-type: none"> What are the environmental sustainability priorities and minimum requirements? Consider: chemicals and components, GWP of refrigerant and insulation foaming agent, reparability, efficiency of operation, end of life provisions. 	4.3.6
	Layout, racking, crates	<ul style="list-style-type: none"> How will the cold room be laid out inside and with what racking and crates for produce? 	4.11
Solar photovoltaic parameters (if solar power is required)	Location for PV modules to be installed	<ul style="list-style-type: none"> PV modules to be installed on top of WICR, roof or on ground. This determines structures required. 	5.3.2
	Autonomy and type of energy storage	<ul style="list-style-type: none"> How much time of autonomy is required to keep the cold room at a certain temperature range? How should energy be stored: batteries, thermal storage, or a mix? 	5.2.1, 5.2.2, 5.2.3, 5.3.3, 5.4.3, 5.5
Maintenance	Maintenance requirements	<ul style="list-style-type: none"> How will servicing and maintenance be managed? How does the chosen location or type of facility impact maintenance planning (if at all)? 	4.3.2, 7.10
Procurement	Route to procure	<ul style="list-style-type: none"> What is the preferred route to procure or gain access to the cold room? 	3.12, 3.7
	Contract(s)	<ul style="list-style-type: none"> What hardware and which services are to be included in which contract(s)? 	3.12

3.10 The Go/No-go decision

Once a specification of the cooling need and an outline of possible solutions built around the local produce value chains are agreed, indicative pricings are obtained, and a good draft of the business plan and financing plan are prepared, then a decision can be made on whether the walk-in cold room proposal seems viable. This should be a clear and planned break point in the project. Write down the specification and details of the solution(s) covering a list of topics like that shown in Table 3.2 and make that available to the decision group beforehand. The staff involved in the Go/No-go decision should include those who understand all main aspects of the need, solutions and wider markets and value chain(s). Try and include at least one independent person who has had less or no direct involvement in the project, to be the 'fresh pair of eyes' and ask awkward but necessary questions. The Go/No-go decision process should not try and cover all aspects, as this would mean no time to dig into anything at all in detail. Instead, focus time on 'showstopper issues' that are crucial and cannot later be overcome or avoided, once in operation. Allow time to properly cross-examine the showstopper risks. Keep notes of challenges and questions raised to be addressed later. If showstopper issues have been properly addressed, it builds confidence that other aspects have too. Above all, trust the evidence presented, not bland reassurances, and listen to the views of independent expert(s) even if they are not always accepted. Be prepared to go back and rework problems or get more advice.

Considerations in the Go/No-go decision will vary by situation and many possible issues are identified in the chapters of this guide. But for a starting point and inspiration, below is a checklist to review whilst preparing for Go/No-go discussions – someone in the team should be able to provide a convincing explanation for each of these issues:

1. Choice of location

- How does the location relate to where farmers, potential customers and other players in the value-chain are? How easy are travel distances?
- Does the location have sufficient road or other connections for flow of produce and ease of access by customers? If it's a case of 'not yet but links are planned', what are the workarounds for delayed completion of those links?
- Is the location sufficiently safe for staff and equipment, or can it be made so within the available budget?
- Is it clear what legal permissions to build are needed, who has to be asked? What permissions have already been secured? What is the confidence level and timeline in remaining permissions being granted?
- Is sufficiently reliable electrical grid available? If not, is an adequate distributed renewable/solar system feasible within budget?

2. Choice of the cold room and refrigerating system

- How has the type and size of cold room been assessed as suitable for the application, given expected produce volumes and how they vary over seasons?
- How was the heat load (cooling demand) quantified and refrigeration system sizing carried out, including characterising the Design Day conditions? What is the confidence level that the cooling plant will be able to meet demands of a typical day and the Design Day?
- How has the solar PV and other backup electricity supply been specified and rated for capacity for the Design Day? What contingency is included? How can future change in demand be accommodated?

- What provisions are in hand for energy storage for limited grid or off-grid and how long could the plant continue to run in poor/no sunshine? How were thermal and/or battery storage specified?
- What feedback has been received from suppliers? Are specifications accepted?

3. Business model and financial plan

- What is the business model in outline, and is detail sufficiently planned? How has it been checked by experts and partners?
- How is the operation of the cold room linked in with local value chains? How does the cold room operation add value to the value chain and activity of the owners/users and how has that value been quantified against its costs?
- Are the necessary logistical links and transport equipment ensured with farmers and customers?
- What financing is in place and what are the timelines for that? Is the financing sustainable?
- If multiple crops are stored, do the operators have the skills to manage the different crops in the room to ensure a longer shelf-life?
- Customers' payments systems: are digital payments established in the country? If not, it is recommended to map the risks and challenges with paper payments and its impact on the business model.

3.11 Detailed specification and design

If a positive decision to proceed is made then the proposals can proceed to full detail specification and design, bearing in mind the feedback of the Go/No-go discussions. These issues are fully explained in Part 4 for design of the cold room and refrigeration plant and in Part 5 for the power supply system.

3.12 Procurement

The procurement process of a WICR can be lengthy and demanding, depending on the procurement policies of the institution financing the system. Whichever way it proceeds, it is important that both buyer and supplier have a common, clear and written understanding of what the need is, what hardware and services are included and when it will happen.

Decide which elements each contract should include. The list might cover these and more:

- Consultancy advice to draw up a full specification based on business and market needs
- Design of hardware
- Supply of hardware
- Shipping and import to the country of use, including insurance
- Transport from arrival port to site, including insurance
- Installation on site
- Commissioning of the equipment
- User training
- Ongoing maintenance

- Warranty
- Spare parts
- Service of remote monitoring

The other sections of this guide provide plenty of inspiration for details that must be considered for a successful outcome.

In the development sector a typical implementation consists of 3 parties: development organisation (procuring the system), supplier of WICR (supplying the system) and the recipient (operating the system). But other actors along the line could also be involved. The supplier might not be the manufacturer (designing and building the system), the recipient might not be the end-user (using the system to cool a product) and after project duration, the system might formally be handed over to public institutions (e.g., organisations, governments). Transportation, installation, maintenance or even commissioning might also involve other parties in the process.

The role of development practitioners lies mainly in the coordination of the above-named involved parties. In this section, the procurement process is described from a perspective of a project officer within a development organisation. Other institutions might have slightly different processes. Also, in this section, the business case of the cooling system itself is not further described (which in the planning process is obviously an important factor).

Once the needs of the end-user are written into the specification, discussions can move on to the available systems. It is the role of the development practitioner to assess and advise on the feasibility of the end-user's requirements with solutions available on the market. For this, it is important that the advising side has a good knowledge of different manufacturers of cooling systems and their main specifications.

The procurement process is usually in the form of a tender, public or restricted. Depending on the procuring organisation, different tender documents are required but a 'neutral technical specification' is usually a document that all do require. This document describes the required parameters and performance of the WICR in a neutral way, so that the process is open for all suppliers with matching solutions. Once the proposals are received, a technical evaluation takes place to see if the proposed specifications match with the required ones. This assessment is critical and should be done involving persons with the right technical and financial knowledge, after which the contract can be awarded.

3.13 Installation and commissioning

The questions and discussion points given in Part 6 should ensure that important points are considered, and a good understanding is developed between the buyer/manager and contractors so that the final installation is done well. 6.1 explains important considerations for installation, including:

- Import and shipping into the country, especially when handling components designated as hazardous such as certain refrigerants and batteries (Subsection 6.1.1).
- Transport to site, where the risks of damage are usually greatest, and effort on careful packaging and selection of experienced shipping agent(s) is paramount (Subsection 6.1.2).
- Preparation of the base/floor of the cold room that must be both smooth and level to avoid problems assembling the panelled structure of a cold room that has to achieve permanently vapour-proof seals in all joints (Subsection 6.1.3).
- Assembly of the cold room, ensuring plenty of workers with skills to handle not only the technical aspects but also the large fragile components (Subsection 6.1.4).

- Careful preparation and briefing of the installation team, to ensure that all tools and equipment are on site and safely stored before commencing. Key consideration is that breaching of the panel skins, seals and joints must be minimised, properly managed, filled and sealed to ensure minimal thermal bridging, mechanical strength and retained vapour seal (Subsection 6.1.5).
- Installation of the power system, for which extensive checklists are provided in Subsection 6.1.6.
- Finally cleaning and ventilating the new cold room (Subsection 6.1.7).

Section 6.2 covers commissioning of the cold room and identifies the critical components of the cold room that need to be checked, tested and measured. The commissioning process should be detailed in the contract between the supplier and the buyer/manager with the steps well defined. Key steps include:

- Structural checks (Subsection 6.2.1).
- Electrical commissioning (Subsection 6.2.2).
- Thermal commissioning (Subsection 6.2.3).
- Refrigeration system commissioning (Subsection 6.2.4).
- Other system checks, including spare parts and system safety (Subsection 6.2.5).
- Sign-off and handover of the cold room to its users, including provisions for training, documentation and use of log books (Subsection 6.2.6).

3.14 Operation and management

Availability of the right hardware is a step towards a successful cold room business, but the cold room must be well- operated and managed to be viable, with careful postharvest management of produce. For effective and sustainable operation of the cold room, understanding what farmers are producing, when they are producing it, and what volumes they should store for future sale at which point are all critical and should influence both the design and operation of the cold room.

Advice for successful operation and management of a walk-in cold room is given in Part 7 of the guide and several key aspects to address are identified in this Subsection:

- a. Develop with staff an operational protocol for the cold room, covering the basic rules and processes that all staff should follow (Section 7.2).
- b. Supplementary checklists can be created for actions on a daily and weekly basis – such as to clean and tidy (Section 7.3), checks for damage and for produce kept too long – plus actions covering specific events such as a delivery of a large batch of produce (Section 7.7). Through initial explanation, repetition and reinforcement in normal daily activity those practices should become automatic.
- c. Have a plan for temperature setting related to what is being stored (Section 7.4). This could be one of the three recommended compromise conditions for short-term storage (Subsection 2.3.6): 'Cold and humid' (0-2°C; 90-98% RH) – most leafy vegetables, brassica crops, and temperate-origin fruit and berries; 'Cool and humid' (7-10°C; 85-95% RH) – citrus and subtropical fruits and many fruit-type vegetables; or 'Moderate' (13-18°C; 80-95% RH) – root vegetables, squashes, and most tropical fruit and melons.
- d. Avoid co-storage of produce that requires a different temperature and humidity or might cross-contaminate with odours or ethylene (Subsection 2.3.6, Section 7.5).

- e. Monitor how temperature is being achieved using an automated system and using intermittent manual checks. Be clear about what temperature is monitored, i.e. spot temperature of the surface of produce or a fitting, product core temperature (using a probe), air temperature of a fixed sensor, or finding coldest or warmest location using a hand-held thermometer. Decide also if measurements should be at a particular instant of time or an integrated average over an hour or day (from an automated system). Keep records of both automated and manual checks.
- f. Plan to keep the cold room active, earning and reasonably full through as much of the year as possible. This requires planning, creative thinking and contact with many local producers and sellers.
- g. For receipt of produce deliveries, have a shaded area to briefly store produce whilst the receipt checklist is being completed. This would include a quality check, registration (Subsection 7.7.2), labelling of crates, taking details of owner/contractor and the produce. Large batches should be graded and sorted before storage (Subsection 7.7.3). Precool produce before it is placed with other produce in the cold room (Subsections 7.7.4, 2.3.2 (science), 4.3.4 (technology)).
- h. Careful loading and stacking is essential to avoid damaging produce and to ensure good airflow through the room and through the produce. Allow at least 10 cm airflow space against walls; use racks rather than crates on the floor; allow at least 25 cm around any fan unit and between top of stacks and ceiling; avoid 'short circuit' routes. Discuss with staff how to ensure good flow of cooled air. Use a loading diagram to record where produce is.
- i. Beware overloading the cooling system. This means respecting the loading limits so that airflow is good; also ensuring produce is precooled before storing. Without precooling, even a half-full cold room may be severely overloaded and be unable to achieve correct temperatures.
- j. Have a system for monitoring technical performance of the cold room: air and produce temperatures; ambient temperature and humidity; energy consumption (and production) (Section 7.8).
- k. Have a system for monitoring operational performance: how well the WICR is operating with respect to the intended business model, meaning food quality, throughput, utilisation, costs and profit (Section 7.8).
- l. Have a system for tracking and managing the inventory: what is stored, where and for how long (Section 7.9). This could be an app (Subsection 7.9.2), digital or paper-based, but should record stock type, in and out dates, quantities and owner/contractor. Ideally, it should monitor market price to prompt good sales opportunities.
- m. Preventive maintenance keeps plant running and efficient. It avoids unexpected failures that are otherwise bound to happen at the busiest time. There should be a weekly maintenance checklist and one every three or six months as agreed with the supplier. One of those checks should be to calibrate temperature sensors (Subsection 7.10.3) by dipping each into an insulated container of water and crushed ice that is well mixed, replacing with a new sensor any that show more than 0.5°C variation from the 0.0°C of the water/ice mixture.
- n. Track the operational expenditure (Section 7.11), covering both inevitable baseload costs that are constant regardless of what is happening (such as rent, staff costs, lease or hire, insurance, etc.) and costs that vary with usage of the cold room and are therefore more directly controllable by staff (such as energy, transport, extra staff, consumables and packaging). Review over time and against the budget from the business plan.

3.15 References

- Efficiency for Access 2023a.** Examining Fiscal Environments for Increased Localisation of Solar Products. A study on solar refrigerators and walk-in cold rooms in India and Kenya. Efficiency for Access, 2023.
<https://efficiencyforaccess.org/publications/examining-fiscal-environments-for-increased-localisation-of-solar-products>
- Efficiency for Access 2023b.** Assessment of the cold chain in India. Efficiency for Access, 2023.
<https://storage.googleapis.com/e4a-website-assets/Assessment-of-the-Cold-Chain-Market-in-India.pdf>
- Efficiency for Access 2023c.** The Potential Role of Concessional Consumer Financing in Energy Access. Efficiency for Access, 2023.
<https://efficiencyforaccess.org/publications/the-road-to-zero-interest>
- Efficiency for Access 2023d.** Life Cycle greenhouse gas emissions assessment of off-and weak- grid refrigeration technologies. Efficiency for Access, 2023.
<https://efficiencyforaccess.org/publications/life-cycle-greenhouse-gas-emissions-assessment-of-off-and-weak-grid-refrigeration-technologies>
- Food Flow, 2022.** Food flow impact report.
<https://foodflow.enviu.org/impact-report-2021/foodflow-impact-report-2022>
- Global Knowledge Initiative, 2017.** Innovating the future of food systems.
<https://globalknowledgeinitiative.org/wp-content/uploads/2018/01/GKI-Innovating-the-Future-of-Food-Systems-Report-October-2017.pdf>
- Oostweche R.J.A., Verschoor J.A., Pereira de Silva F.I.D.G., Hettterscheid S., Castelein R.B., 2022.** Postharvest Assessment Methodology: conceptual framework for a methodology to assess food systems and value chains in the postharvest handling of perishables as a basis for effective interventions. Report 2359 / Wageningen Food & Biobased Research.
<https://doi.org/10.18174/582556>
- Mc Carney et al (2013).** Using solar-powered refrigeration for vaccine storage where other sources of reliable electricity are inadequate or costly, McCarney et al, Vaccine, Volume 31, Issue 51, Dec. 2013
- University of Birmingham (2017).** *India's Third Agricultural Revolution*. Available at:
<https://www.birmingham.ac.uk/Documents/college-eps/energy/Publications/india-third-agricultural-revolution-birmingham-energy-institute.pdf>

HEAT AND TEMPERATURE

SOLAR COOLING

Thermo Box Dimensions			
H [m]	W [m]	L [m]	Volume [m ³]
0.5	0.3	0.4	0.06

Volume to Mass Calc	
Air	
Volume	0.06 m ³
Average density	1.224 kg/m ³
Mass	73 g

Mass to Volume Calc	
Water	
Mass	73 g
Volume	0.7 dl

4

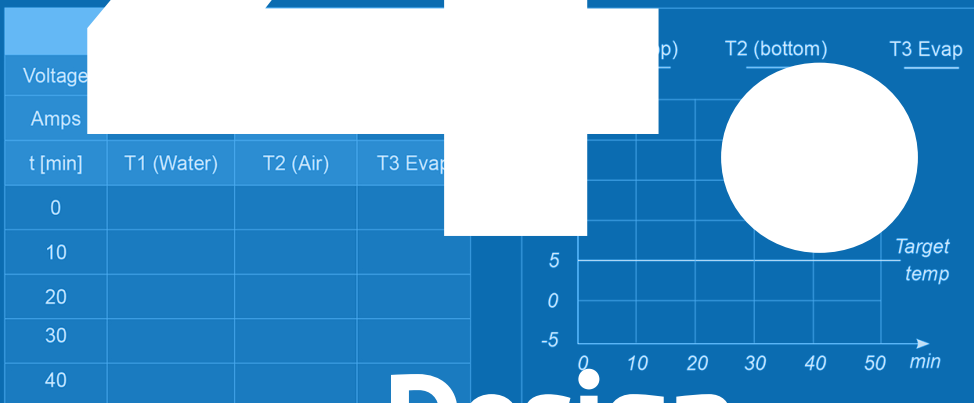

Design of the cold room

Tab.5 Heat Capacity

	c	ΔT	m	Q
	Specific heat capacity	Temperature difference	Mass	Heat
	kJ/kgK	K	kg	kJ
Air	1.004			
Water	4.175			

Note: 3,600kJ are equal to 1kWh

4. Design of the cold room

4.1 Introduction to the design of a cold room

The detailed design stage should not start until an outline business plan and careful specification have been written down and agreed. The specification must quantify the cooling needs necessary to make the cold room business viable and is addressed in Part 3, so read that before the detail on design. A well-specified cold room should achieve what is needed, and, if well designed can not only be energy-efficient and cost-effective to operate, but will also operate more reliably, need less maintenance and achieve a longer service life. The cost to purchase the cold room plus its lifetime operating costs must be balanced against what can be achieved with the equipment, in terms of increased revenue from the produce, reduced food loss, etc. A cold room that has a low initial cost is not economical if it costs far more to operate every day of its life or is unable to deliver the needed cooling. The business plan must balance how much value is added to the produce and the lifetime cost of ownership for the cooling equipment.

This chapter covers design of the refrigerated facility, which should be considered alongside the business model and finances available for the build. This may be an iterative process where the best options for a particular situation may need to be adapted to find the best financial and technical option for the owners, end users and operators.

Generally, most small cold rooms and chillers will be supplied by a single supplier who provides all components and installs the facility, often based on a 'standard' design. As a result, the scope for a buyer or owner/operator to change the specification or design may be limited. However, some modular adaptive solutions are also available. An example of a flexible, modular refrigeration system approach is described in the box below.

One supplier has developed a 'plug-and-play' refrigeration unit for off-grid cooling applications including cold rooms. It is based on the concept of a hermetically sealed refrigeration circuit that includes a DC-compressor condensing unit and copper pipework to an evaporator plate that can be used in different ways, supplied with matched solar modules. The small solar-powered cooling units can be configured to cool air or liquids or make ice baths for thermal energy storage. Units can be used singly or multiplexed with six or more driven by a single controller when higher cooling capacity is needed. One application example is generating ice in a water reservoir for energy storage (Figure 4.1). The cold energy stored can, for example, be used through water circulation to a fan coil unit mounted in the cold room. The thermal storage allows meeting high peak demand even when the power supply is intermittent.

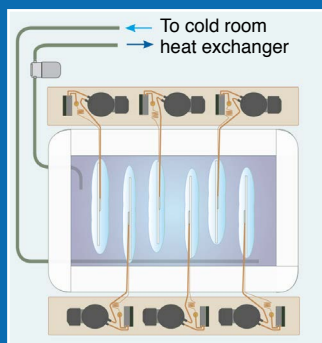

Figure 4.1

Diagram of a modular cooling unit with ice storage, showing six refrigeration circuits, each with a condensing unit piped to an evaporator plate mounted in the water bath, with all six multiplexed together under one controller (*Solar Cooling Engineering*).

in a water reservoir for energy storage (Figure 4.1). The cold energy stored can, for example, be used through water circulation to a fan coil unit mounted in the cold room. The thermal storage allows meeting high peak demand even when the power supply is intermittent.

The modular and flexible system approach enables reconfiguration and expansion as the business or application demand changes, working with other locally available components as needed. Use of hydrocarbons as refrigerant promotes sustainability reducing to almost zero the in-use CO₂ emissions.

Two reasons why the details in this section are worth reading:

1. There is a competitive market and advice in this section will help identify which cold room product is the best for your situation.
2. The information enables much more focused and effective discussions between customers and suppliers, so that better solutions become more widely available to all.

The chapter explains the hardware that is needed to provide the cooling and care of produce that is described in Section 2 of the guide. This chapter covers:

- Basic components and working of a generic refrigeration system (4.2)
- Priorities to have in mind as the design proceeds (4.3)
- How to quantify the heat load that the system must address (4.4)
- Sizing the refrigeration unit (4.5)
- Design of the insulated structure (4.6)
- Quantifying the electrical demand of the system (4.7)
- Considerations for refrigerants (4.8)
- Design of specification of ancillary systems needed for the cold room to function (4.9)
- Options for monitoring system performance (4.10)
- What to put where and why – layout of equipment (4.11)
- How to ensure safety of users and plant (4.12)
- List of references for more detailed reading

Finally, there is an appendix for a more detailed analysis of the heat load. Note that technical guidance associated with thermal energy storage (TES) is addressed in Part 5, although this Part does consider where TES should be situated in the cold room under section 4.11.

4.2 Basics about refrigeration

4.2.1 Types of vapour compression system and how they work

A refrigeration system transfers heat from a low-temperature reservoir (the cooled space) to a high-temperature reservoir (outside air). Most small walk-in cold rooms use monobloc units for which the whole refrigeration system is in one 'through the wall' package (air cooler part of the unit hangs inside the room; compressor, condenser and controls hang outside) with commercially available capacity range between 1.5 and 22 kW. Larger cold rooms tend to have a split system with the condensing unit outside joined by pipework to one or more air coolers located inside the room (see Figure 4.2).

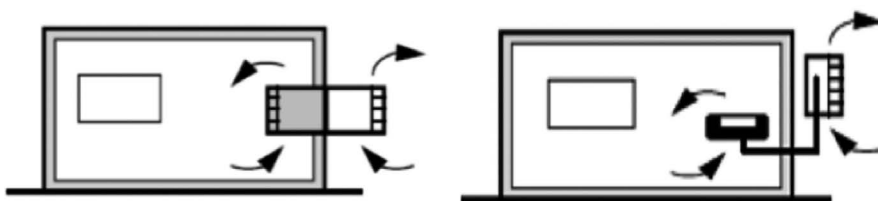

Figure 4.2

Through the wall packaged unit or monobloc (left) and split type unit (right).

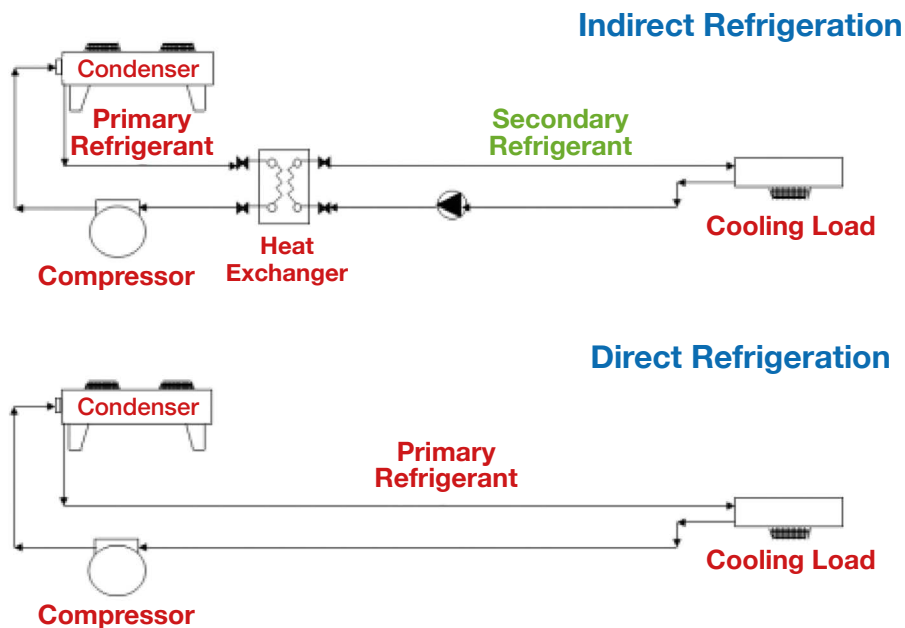

Figure 4.3

Comparison of the basic configuration of indirect refrigeration (top) and direct expansion (bottom) refrigeration systems.

Split systems are either 'direct expansion' type with refrigerant piped to the air cooler unit or 'secondary refrigeration' (or 'indirect') type with brine or another secondary fluid carrying the heat from the air cooler to the refrigeration unit (see Figure 4.3). A variant of the indirect system is also commonly used with thermal energy storage (TES) in the form of an ice bank or other phase change material (PCM). In such a system, the primary circuit can store its cooling output in the TES in times of surplus power (i.e. freeze the ice bank) and the secondary circuit can subsequently take cooling from the TES or from the primary circuit, or from both, to meet peaks in power or continue to operate through periods with zero or low power availability.

This guide is focused on systems with a particular cooling technology. These account for the vast majority of currently installed walk-in cold rooms. A vapour compression cycle consists of an evaporator, a compressor, a condenser, and an expansion valve (Figure 4.4) and uses a refrigerant or a secondary working fluid to transfer the heat. Most systems include other key components:

1. Dual (high and low) pressure controls
2. Service valves
3. Service access points, typically Schrader valve connections
4. Liquid receiver
5. Filter drier
6. Solenoid valve
7. Sight glass
8. Electronic controls

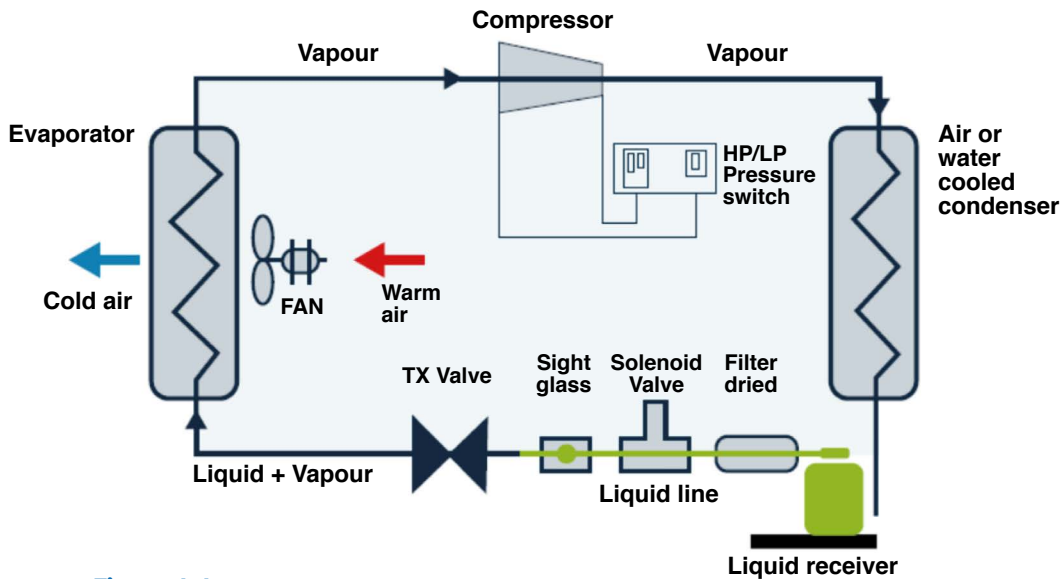

Figure 4.4
Typical single-stage vapour compression refrigeration system.

Compressor: Compressors are generally the most expensive single component of the plant. Reciprocating type compressors are generally used in smaller cold rooms, usually hermetic or semi hermetic which contain the motor within the sealed refrigerant system. Refrigeration compressors can be fitted with either fixed or variable speed electric motors. Conventional compressors run on AC power but compressors that run on DC input power are increasingly available and becoming widely used on off-grid refrigerating equipment. Variable speed compressors ('inverter driven') are being more widely applied for off-grid use as they do not incur the in-rush currents during start-up that are problematic to some electrical supplies. DC compressors also have this benefit. Variable speed compressors can also match capacity more closely to the cooling demand and so operate more efficiently.

Condenser: For most small systems, dry air-cooled condensers are used. Selecting a condenser of the correct size for the application is very important for capacity and efficiency and for operation during hot weather.

Expansion valve: The expansion valve controls the flow of refrigerant to the evaporator. Thermostatic or electronic valves are used in most small stores.

Evaporator: Most evaporators used in walk-in cold rooms will be finned coils. Evaporators are sold generally in complete units, with suitable fans, casings and defrost drip trays incorporated. Most examples will be made of copper tube with aluminium fins.

Refrigerant: The refrigerant is a working fluid used in the refrigeration cycle with repeated phase change from liquid to gas and back again, extracting heat from the cold room, or from the secondary fluid in an indirect system, and rejecting the heat outside. Refrigerants are regulated due to toxicity, flammability, ozone depletion and global warming impacts. More detailed info on the selection of the most appropriate refrigerant can be found in Section 4.8.

Fans: Fans are used to force air through the evaporator and generate a circulation of air around the cold room. In general, larger fans with lower speeds are more energy efficient than small and high-speed fans. The energy used to run fans ends up as heat in the cold room, so their efficiency is important. Electronically commutated motors (ECMs) are speed controlled, highly efficient across most of the speed range, quieter, and extend the life of the motor.

4.3 Overall design priorities for the cold room

These are the key points to discuss with your system supplier.

4.3.1 Design priorities and achieving good energy efficiency

Design priorities are crucially dependent on the specification and how the cold room is planned to be used, so ensure that Part 3 is completed before focusing on design in this part. For example, if produce can be harvested and loaded into a solar powered cold room in the morning, then the maximum benefit of solar power can be achieved as cooling is driven throughout the day; whereas a solar-powered cold room usually loaded in the evening will need critical amounts of stored energy or thermal storage. For energy efficiency, investment to reduce heat loads and use an efficient refrigeration system means less solar panels and thermal storage is needed and operational costs are lower when operating from the grid. The impact of operating costs versus capital expenditure needs to be assessed when specifying and designing a chiller/cold room facility. Further details of aspects that should be considered include (further details of each are provided in the sections below):

1. It is essential to provide precooling for foods as soon after harvest as possible according to the specific needs of each type of produce, to uphold food quality and safety. Cooling achieved in the first hour after harvest has the most benefit to reducing food loss and upholding quality (see Sections 2.3.2 and 4.3.4). Produce harvested in the early morning requires less precooling due to the lower plant physiological activities and lowest daily ambient temperatures.
2. Ensure shading for the cold room to prevent direct solar radiation heating up the outer walls of the room; and provide good free flow of air for the condenser to allow the best possible heat exchange. Solar panels can be placed above the cold room to provide shade while capturing solar radiation (see 4.14.3, 5.4.1).
3. Consider using renewable energy sources as they can reduce operating costs. As these resources are not available continually, thermal or electrical energy storage must be integrated. Thermal storage has great benefits as it is generally less expensive than electrical storage, has a longer life span and is more environmentally sustainable than using electrical batteries (see Part 5 on Energy supply and storage systems).
4. Low price components may be available but often represent a false economy. For example, undersized evaporators and condensers, or compressors that are incorrectly sized for the facility will all lead to higher running costs, lower reliability and often poorer performance, which reflects food quality. Trying to save money through using low price and less effective insulation (thinner, lower quality) is usually a false economy as it makes it harder to achieve correct temperatures, increases system losses and cost of operation. Remember that every additional degree of temperature difference between the evaporating and condensing temperatures increases energy used by 1-2%.
5. In terms of the critical system components:
 - **Insulation:** Check insulation thickness, also for the floor thermal conductivity and expected degradation of the material over time. Assessment should be based on 'aged state' thermal conductivity, not on the properties at the time of the manufacture. Most chilled cold rooms should use at least 100 mm thick insulation with an aged thermal conductivity of $\leq 0.02 \text{ W.m}^{-1}\text{.K}^{-1}$. Where blown foam insulation is used, the blowing agent must not be CFC- or HCFC-based

and other important environmental impact considerations should be taken into account for the insulation, as explained in Section 4.6.1. At the time of installation, it is crucial to work precisely and seal all corners and edges to prevent heat bridges and associated heat losses.

- **Door:** The door must fit precisely and must be able to close without air leakage. It is recommended to use a PVC strip curtain behind the door to reduce loss of cold air and entry of humidity when the door is open (see Section 4.6.3).
 - **Compressor:** Variable speed compressors match load to power demand and are generally more efficient. DC compressors are now widely available, efficient and highly suitable for solar direct drive and other small- to medium-sized off-grid system types. Capacity control by switching the compressor off and on, accepting a slightly wider tolerance on cold room temperature, may in some cases also be an efficient way to operate.
 - **Condenser:** Condenser sizing has a big impact on efficiency and running cost and is especially important in high ambient temperatures. Although manufacturers' standard data often includes a condensing temperature 17°C above the ambient air entry temperature, a lower difference is highly recommended, preferably between 10°C and 15°C above the ambient air entry temperature. Energy efficiency is better and running costs lower if a 10°C or less temperature differential is used. Since this means needing a larger surface area of condenser, the initial capital cost will be higher, but this is usually cost effective and gives a system better able to cope in higher ambient temperatures as every additional degree of temperature difference between the evaporating and condensing temperatures increases energy used by 1-2%.
 - **Evaporator:** Equipment should be sized to minimise the difference between the evaporating temperature and the temperature of the cold room, which means selecting evaporators with a larger surface area (unless, for some reason, there is a need for low humidity in the cold room, see Subsections 2.2.3 and 2.3.3). Generally, 13-14 m² of evaporator surface area per kW of cooling load is sufficient (evaporator manufacturers usually quote the surface area in their technical specifications). Surface area of the evaporator includes fin and tube surfaces, it is not the frontal area.
 - **Fans:** Choose larger diameter fans which give better air distribution over the coils and low power consumption. Consider specifying variable speed, high efficiency fan motors for better temperature control, higher efficiency, quieter running, lower running costs and longer working life of the motor – the additional costs can certainly be worthwhile for many applications. This means use of permanent magnet (PM) motors with electronic switching circuits that could be brushless DC (BLDC), or other types of electronically commutated motors (ECMs). Motor efficiencies of 70% are achievable with these.
6. Make sure that the refrigeration system is designed to operate using refrigerants with zero Ozone Depletion Potential (ODP) and low Global Warming Potential (GWP) (see Section 4.8 on refrigerant choices). An initial assessment needs to be made of availability of refrigerants within the local area and their price. However, best practice would be to use a refrigerant with zero ODP and a GWP of less than 150. Consider a refrigeration unit that comes prefilled and sealed, which virtually eliminates refrigerant leakage (except by damage) and thus avoids maintenance refills.
 7. Ensure that facilities are designed to be easy to maintain as this is crucial to efficiency (see the following Section 4.3.2). Ensure that materials and components are selected to be available within the local area for future repairs. Install a temperature monitoring system, preferably remote.

4.3.2 Design for reliability and ease of maintenance

Cold rooms are required to operate in harsh conditions, often far from easy sources of spare parts and specialist technicians. This makes design for reliability and design for ease of maintenance important priorities.

A modular approach to the system design should be considered, in which two or more smaller systems are operated in parallel to deliver the total cooling demand; if one refrigeration unit fails, the other unit(s) can provide cooling. At times of low demand, only one unit needs to operate at a higher (and so more efficient) loading level; and the modular approach lends itself better to reconfiguration as business needs evolve (see Section 3.3).

A maintenance protocol for the refrigeration plant is essential and fully integrated operating manuals should be provided (see Section 7.10). These should identify components, operating and maintenance data, procedures to be used for testing items that may need replacing during the life of the plant and commissioning and testing documentation.

The plant can be designed to make diagnostics, maintenance and repair as easy as possible¹. Key considerations are:

- Provide a troubleshooting guide and instruction manual and update when modifications are made.
- Use commonly available components for which spares are accessible.
- Make components easy to locate with clear labels, wiring and plant diagrams, enclosures that allow plenty of space for components and hands to access. Keep the design and installation tidy.
- Make components easy to access by use of common types of reusable screws and fasteners; no welding or glued access for components that may need replacement. Eliminate or greatly reduce the need for specialist tools in repairs and access.
- Provide a list of the toolkit needed for repairs; and design the system to keep that tool kit list as short and simple as possible.

4.3.3 Design for reconfiguration

At the start of a project, consideration should be given to the future needs of the facility – how usage and cooling needs might change in six months, one year, two years or longer. Generally, the facility should be designed to cope with adverse weather conditions and have some spare capacity. If it is not clear at the start how future needs for the facility might evolve, it may be worth considering a modular design where additional cooling units and storage space can be added. These could be based on a modular refrigeration system so that additional cooling systems and evaporators are added, and insulated panels that can be reconfigured. It is also worth considering whether the facility will need to be moved at any stage (e.g. due to change of ownership of land). Modular containers are an ideal option if this is the case, as they can be moved to a new location.

¹ EN 45554 General methods for the assessment of the ability to repair, reuse and upgrade energy-related products; also Pathways to Repair in the Global Off-Grid Solar Sector, October 2020, Efficiency For Access Coalition & The University of Edinburgh (<https://efficiencyforaccess.org/publications/pathways-to-repair-in-the-off-grid-solar-sector>).

4.3.4 Design for precooling of produce

The need for precooling and the main ways in which this is achieved are described in Subsection 2.3.2. Essentially, a dedicated chiller should be used to remove heat from the product after harvest, separate to the cooling system keeping stored produce at the correct temperature. Without a chiller dedicated to precooling, the rate of temperature reduction of produce can be slow and the temperature (and quality) of the produce already in the cold room will be compromised by the heat brought in with the warm produce.

Whilst hydrocooling (with chilled water sprays or bath) is fast (< 1 hour), it is more expensive and resource-intensive to implement with a need to constantly sanitise re-used water to minimise build-up of decay organisms. This means that most produce in the target markets for this guide are chilled by forced airflow. Forced airflow precooling can be batch-by-batch in a separate or combined blast chiller that takes up to a few hours, or in a part of the storage area that is curtained or walled off from the main storage space and would take several hours to days to reach target temperature.

Good design for precooling includes to:

- Set up a shaded holding area near the cold room for short term storage of produce as it arrives from the field.
- Design in a separate or partitioned space for precooling in or near the store, so that previously stored produce does not get re-heated with each new delivery.
- Generate good airflow in the precooling space, including through racks and packaging (see Subsection 4.11.2).
- Allow a higher pro-rata proportion of refrigeration cooling capacity for the precooling space.

Achieving airflow is a major challenge for forced air cooling, often overlooked by system designers and operators: it is essential that produce is loaded carefully for airflow and that air is prevented from bypassing the produce (finding a 'short circuit'): open spaces around the produce should be deliberately blocked to force air through the stack of produce. Crates should be used or 'spacers' can be placed between layers of produce to distribute air as evenly as possible.

Research and practical ideas for design of small-scale precooling systems are given in a paper published by Kitinoja and Thompson, 2010. Sketches of a simple precooler are given in Figures 4.5 and 4.6 that creates the fast airflow directly over produce that is needed for rapid forced air cooling: the fan draws air through the crates containing warm produce and into the tunnel between the two crate stacks then out through the fan. The reinforced canvas cover must seal down to the floor level at back and to the board on which the fan is mounted at front; gaps between crates on outside must be covered so that air is forced through holes in the crates. Further simple constructions for precooling equipment are published by NC State University in the USA².

Chilling can be faster as air temperature is lowered and/or air speed is increased. But higher air speed requires larger and more powerful fans (which use significantly more energy and put more heat into the circulated air – electrical power of a fan increases with the cube of velocity). Heat transfer is also limited by the size and proportions of the produce and its stacking – smaller or thinner produce cools faster; produce with deeper cross-section or densely packed takes longer, even with high air speed. There is a practical upper limit of around 1 metre depth of crated produce through which air can be drawn before fan power needed becomes excessive³.

² NC State University, *DIY Postharvest Equipment*.

<https://ncfreshproducesafety.ces.ncsu.edu/ncfreshproducesafety-postharvest-diy-postharvest-equipment>

³ NC State University, *Forced-Air Cooling, Postharvest Technology Series*, M. Boyette, L. G. Wilson, E. Estes, July 1, 1989, AG-414-03. Available from: <https://content.ces.ncsu.edu/forced-air-cooling>

It is best to cool in stages with high air velocity at first, reduced once the product surface is close to the air temperature. This reduces weight loss and dehydration and cuts the energy requirement.

The forced air can also be saturated with water to reduce the drying effect on produce (Figure 4.7), with air recirculated over ice-cold water so that air leaving the cooler is at 0 to 1°C and virtually saturated (100% RH). This can be achieved using an ice bank chiller with an evaporator (plate or coil) immersed in a tank of water. During times of low load and either cheap or free (solar/wind) electricity a store of ice is built up on the evaporator that subsequently melts to maintain temperatures during forced air cooling. An economic analysis is needed to determine value for money from such a system. Also using large coils may allow keeping high RH.

Note: If precooling is not available at a cold room site, then it is important to set a suitable limit for the rate at which warm produce can be loaded into the cold room to avoid overloading the cooling system and ending up with the cold room totally unable to achieve the temperature. The supplier or designer should be able to suggest a suitable limit – but this can be checked and refined by experience.

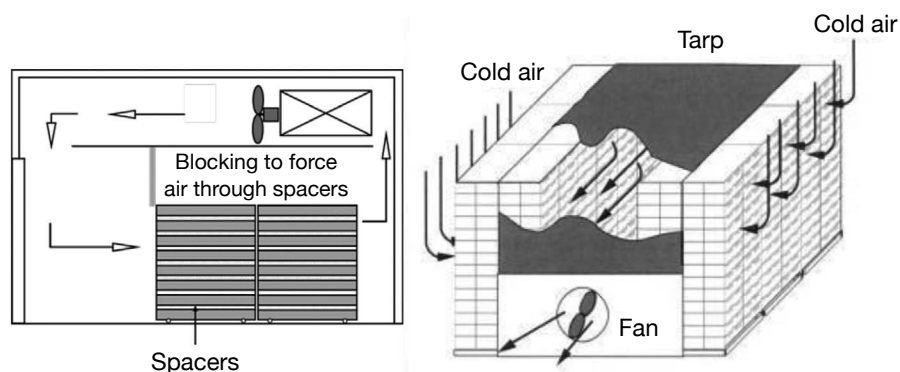

Figure 4.5

Air blast chiller designs showing spacers and block or tarpaulin to force air through stack of product (Kitinoja and Thompson, 2010).

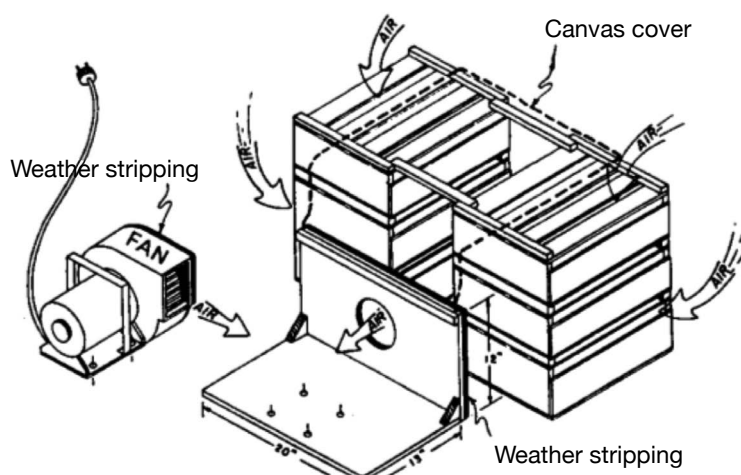

Figure 4.6

Sketch of a simply constructed and portable forced air cooler that can handle around 6 crates at a time (Parsons and Kasmire, 1974).

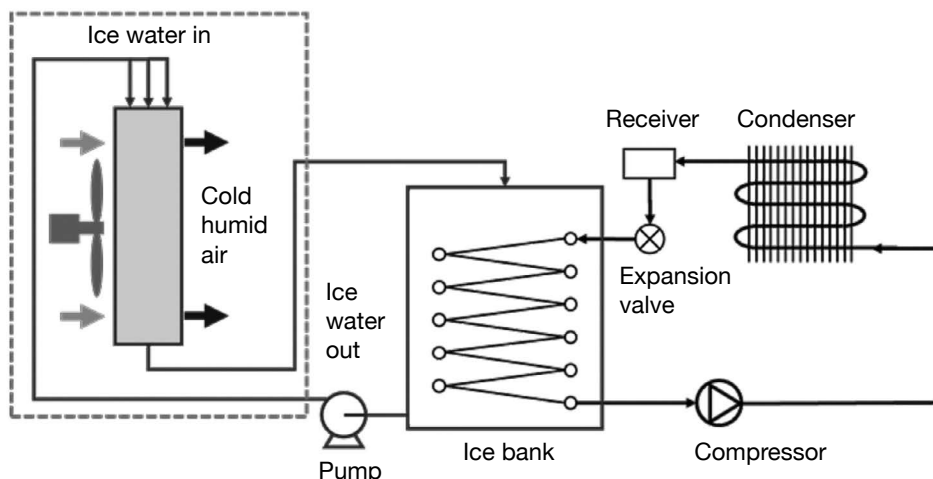

Figure 4.7
Diagram of a wet air chiller utilising an ice bank refrigeration system.

4.3.5 Design for flexibility and seasonality of loading

If the heat load estimate (explained in Section 4.4 below) suggests large variability in the heat load due to either seasonal or daily loading cycles, then this can be factored into the design of the cooling system to ensure good efficiency. Cooling systems with fixed capacity that are forced to run at below half of full load (e.g. at quieter times or if significantly over-sized) run less efficiently and will start/stop cycle regularly, which reduces reliability and can cause premature failure. Discuss two aspects of this with your supplier: firstly, whether a variable speed (variable capacity) system would be appropriate and affordable, which can match capacity to the heat load. Such systems can generally achieve good efficiency at anywhere between 25% and 120% of their nominal cooling capacity. They also enable closer control of the storage temperature and have reduced in-rush current (see Subsection 5.2.3). Bear in mind that initial cost is higher due to the variable speed control and drive system and some types of electrical interference can be caused in the power circuit. The second option to consider is a modular system design which can either be 2, 3, 4 or more separate integral cooling systems that can be switched in and out as needed (see Box in 4.1) or a more traditional dual compressor system. In either case, one unit can be sized to deliver a baseload and could be variable capacity if efficiency and control justify the extra investment. Others are introduced as needed for periods of higher demand and can be fixed capacity if in rush currents are managed. Thermal energy storage can also be designed into the system to address variable demand (Figure 4.8) (see Box in Section 4.1, Section 4.5 on sizing of cooling systems and Section 5.5 on thermal energy storage).

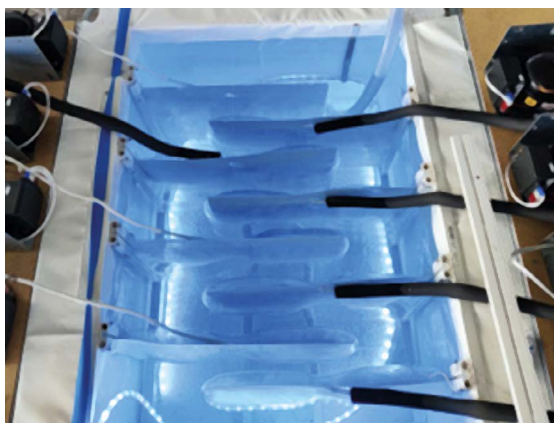

Figure 4.8
Ice-based thermal storage with separate evaporators and cooling units.

4.3.6 Design to minimise environmental impact

Each relevant section of this guide provides advice to minimise environmental impact of walk-in cold rooms and their usage. Those impacts to minimise include impacts of electricity use, chemicals and materials used in building the unit and those left over after it is decommissioned. The impacts from manufacture of components must also not be forgotten and can be considered in their selection through information on manufacturing processes and selecting longer lasting and repairable components. A study published by Efficiency for Access⁴ provides an overview of the life cycle greenhouse gas (GHG) emissions assessment of two types of 20 cubic metre solar powered walk-in cold room. The study considers direct and embodied GHG emissions linked to raw material production, manufacturing processes, transportation, operations, and end-of-life phases. The broad conclusions are that embodied GHG emissions from manufacturing of the cold room, cooling equipment, solar PV, and energy storage account for over four fifths of the total life cycle impact. The main components with embodied GHG emissions include refrigerants, blowing agents used for insulation, solar PV panels, and batteries. The use phase of these solar powered units accounts for less than 2% of the life cycle impacts, as they are driven by 100% renewable energy. Careful design and choice of components can enable recovery of materials at end of life which offset up to a quarter of the life cycle GHG emissions (but of course only if recovery is achieved when that time comes).

4.4 Heat load assessment

This section gives an overview of how to estimate each of the twelve or more anticipated heat loads to enable a detailed discussion with your system designer. The total heat load gives rise to the cooling load, which is used to size the refrigeration plant as shown in Section 4.5 on sizing of the cooling plant. A reasonable estimate of the heat load is worth spending some time on because if the cooling system does not have sufficient cooling capacity to meet the typical daily loading of the store, then produce quality will suffer and the investment in the cold room will not be worthwhile. But the heat loads accrue from many sources (listed below), which all vary by time of day, ambient and sunshine conditions, type of business or operational plan (i.e. mass of produce added, how the product is loaded, and the time of day and season), and this must be factored into heat load estimates. For a cold room, peaks in demand are likely to occur when a large amount of warm produce has been placed in the precooling zone (see Subsection 2.3.2), when ambient conditions are warmest around midday (depending upon shading of the store) and when doors are being opened often.

This section of the guide helps quantify the heat load with which the refrigeration system will be designed to cope, with judgements needed on what conditions might be on a 'typical day' as well as what the highest (peak) conditions might bring. The larger the cooling capacity of the system, the more expensive the system will be but the cheaper it will be to operate. Therefore, a compromise must be made between the purchase and running costs of a system with the chosen cooling capacity versus the business revenues that the system enables. Higher cooling capacity means better quality control of a higher volume of produce, but will cost more to buy and (generally, but not always) more to run and maintain.

Through preparing an operational plan that includes estimated produce volume throughputs and discussing this with your supplier, it should be possible to agree on a 'Design Day' load,

⁴Life cycle greenhouse gas emissions assessment of off- and weak-grid refrigeration technologies, April 2023, Efficiency for Access Coalition. Available from: <https://efficiencyforaccess.org/publications/life-cycle-greenhouse-gas-emissions-assessment-of-off-and-weak-grid-refrigeration-technologies>

around which decisions on capacity and other functionality can be made. The overall Design Day conditions are built up from judgements on each of the heat loads in turn. It might be worth running the calculations a few times, starting with what you estimate as a typical or average day in average conditions – an 'Average Day' – then a day with the toughest conditions that would be anticipated during the year (high summer, high harvest load, lots of throughput etc) – this would be a 'Peak-of-year Day'. The 'Design Day' conditions would be somewhere between the Average and the Peak: in the mid-zone between the two if costs are tightly constrained; closer to the peak if the business is able to invest for higher resilience, keen to ensure good service on busy days and looks further ahead to future expansion. In any case, you will want your Design Day conditions to be a good deal tougher than the average day so that you have spare capacity most of the time.

Bear in mind that the impacts of poor weather for generating solar power are separately addressed in Subsection 5.4.1 – this section only addresses safety margins for the cooling load.

Topics to research and consider, then discuss with your suppliers include:

- What is the maximum likely product load to be cooled and stored (kg per day), and what types of produce?
- What are the highest average monthly ambient temperatures (which are indicative of the temperature that produce may have when entering the cold room)? Note that the temperature of some of the produce can get much higher than the ambient air if left in direct sun, so keep it in the shade.
- Consider carefully how precooling will be achieved – see Subsection 2.3.2, and section 4.3.4 above.
- Is there a significant fluctuation or seasonality in the cooling demand on the refrigeration system?
- In what ways can the impacts of varied cooling demands be mitigated? For example, by increasing utilisation in low periods, use of thermal storage to meet some of the peak load, limiting the amount of produce permitted to be added at peak periods (to protect produce already there), using a variable speed or modular system that can more closely match operational costs with loading levels.

These considerations should be part of the specification for the facility. The main components of the heat load on a cold room are illustrated in Figure 4.9, with a more complete list below and further detail given in Figure 4.10:

1. Transmission through room walls, ceiling and floor, including effect of solar gain (radiation) on the outside shell. This depends on orientation and geographical location, shading and time of day, which all influence the surface temperatures experienced, with K-values of surfaces and conductivity of the insulation impacting the transmitted heat load.
2. Air change load: infiltration of warm air whenever the door is open and ventilation through fresh air exchange for dispersing ethylene and CO₂.
3. Heat from fans used to move air around inside the cooled space.
4. Any heat used to defrost evaporators (Ideally it should be passive).
5. Assuming that a precooling provision is made in the system design, heat from warm product and its packaging that is being pre-cooled prior to being loaded into the storage area, removing the field heat as rapidly as possible (see Subsection 2.3.2 on precooling produce).
6. Any residual heat in produce that is placed in the store, either from inadequate precooling (perhaps under time pressure) or for any produce that is not pre-cooled and brought straight into the cold room (this should be avoided if possible!). To this must be added the heat generated by respiration of the produce after it reaches the correct temperature (see Subsection 2.2.2 on respiration).

7. Heat from lights.
8. Heat from equipment or machinery brought in from outside and used in the store.
9. Warmth added from people working in the store.
10. Heat from any door, window or floor heaters.
11. Any cooling of thermal storage packs, including any used externally for delivery vehicles.

Some of the loads in the list above may be constant; others only operate for short periods that may or may not overlap. This needs to be considered in the estimation of Design Day loading to only include loads occurring all at the same time. For example, if the facility lights are never on when the refrigeration system defrosts then those loads do not need to be added together to estimate the Design Day load.

The analysis must consider how the facility will operate to accurately estimate the heat load.

As cold rooms for frozen commodities are not within scope of this guide, heat extraction to freeze products (latent heat) is not considered (but can account for a significant part of the total when cooling from ambient to a frozen temperature). Note that production of ice is beyond the scope of this guide.

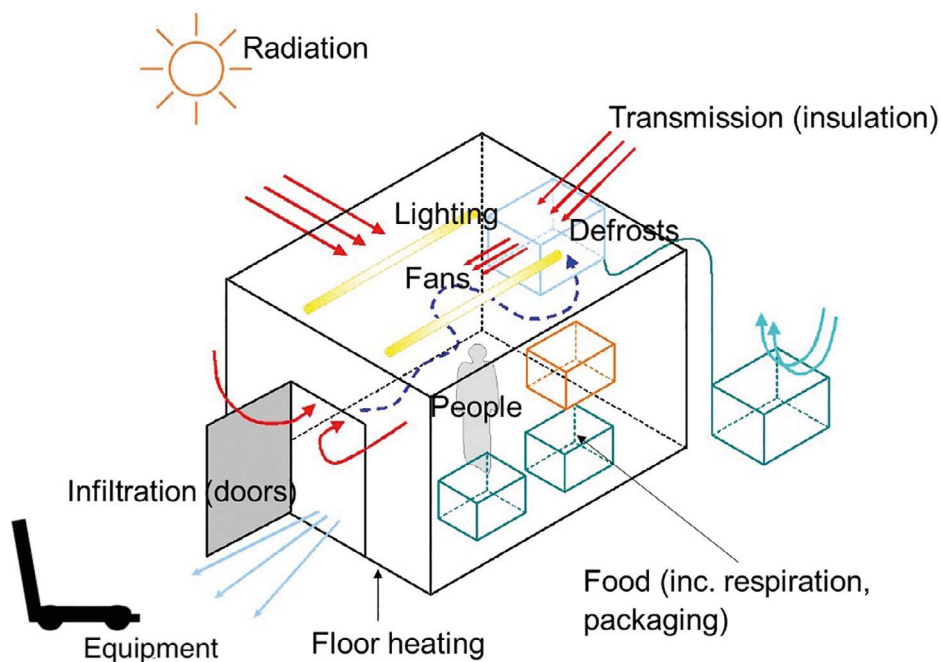

Figure 4.9

Illustration of the main heat sources contributing to the total cooling load (and cost of cooling) for a cold room.

Two further heat loads are considered in addition to those shown in Figure 4.9:



1. Cooling of thermal storage packs: Cooling need can be estimated if the following is known: number and mass of packs per day, starting temperature (presumably equal to ambient) and target cold temperature, specific heat capacity of the packs (energy extracted per degree temperature change), as well as the latent heat of fusion of the packs if a freezing of the fluid is to occur (happens at 0°C for water but may occur at higher or lower temperatures for other fluids). See Section 5.5 on Thermal Energy Storage.

2. Other processing needs could include:

- Drying of food, making use of waste heat from the condensers.
- Pre-heating of water for washing by making use of heat from condensers or a desuperheater heat exchanger, although cost-effectiveness for small systems is challenging.

Formulae and calculation methods to make full assessment of these are given in Appendix 1. Alternatively, there are free issue spreadsheet tools and commercial software available to help users and designers calculate heat loads. For example:

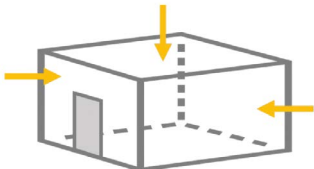
- The ICE-E model is free and simple-to-use with both steady state calculations or variable ambient conditions to calculate heat loads dynamically over a whole year. Its analysis of energy saving measures enables assessment of the impact of improving fans, lights and insulation. Whilst the effect of door opening is considered in a simplistic way, its validity for walk-in cold rooms is not good (it overestimates loads). If data on the refrigeration plant is entered, the model can calculate the energy used. Peak heat loads can be checked against the capacity of the refrigeration plant.
- Information on local ambient conditions can be obtained (usually free) from local weather stations. Otherwise, RetScreen⁵ is a good source of information on ambient conditions and includes information on solar radiation and wind speeds. RetScreen is also useful as it can calculate paybacks and return in investment for a project based on either user input information or standard available costs within the model. EnergyPlus should also be mentioned for heat load calculations.

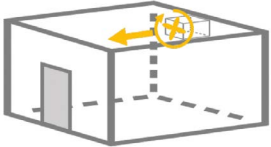
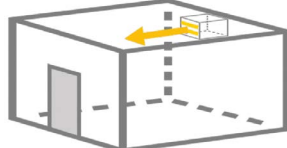
 <p style="text-align: center;">Transmission</p>	<p>Heat load transmitted through the cold/chiller room fabric due to the temperature of the outside air in contact with the insulation (see also solar gain below).</p>
 <p style="text-align: center;">Infiltration</p>	<p>Infiltration of warm and moist air through open doors, faulty seals and joints around doors and between wall panels.</p>
 <p style="text-align: center;">Fans</p>	<p>Heat introduced by fans. Most fans in cold rooms are used on evaporators to distribute the air around the cold room. Occasionally additional fans are used to distribute air in low air velocity areas of a cold room (most usual in produce stores). All of the electrical energy used by the fan is dissipated into the cold room as heat.</p>
 <p style="text-align: center;">Defrosts</p>	<p>Heat from defrost systems. This is primarily related to electric and hot gas defrost (active) systems. Chilled rooms may operate using a 'passive' or 'off-cycle' defrost which does not introduce additional heat but relies on redistribution of warmth already present in the cold room to melt the ice.</p>

⁵ RetScreen can be accessed at: <https://www.nrcan.gc.ca/maps-tools-and-publications/tools/modelling-tools/retscreen/7465>



 <p>Food</p>	<p>Heat load from the stored produce: a) any precooling for removal of field heat to reach the required storage temperature (unless a completely separate system provides that function); b) heat from respiration and packaging, as paper-based packaging is hygroscopic (absorbs water) and causes a latent load when moisture condenses and is absorbed into it.</p>
 <p>Lights</p>	<p>Heat load from lighting can be assumed equivalent to the total power demand of the lights since all of that energy will end up as heat.</p>
 <p>Machinery</p>	<p>Heat load from any machinery in or entering the cold room. In larger stores, the heat load from an electric forklift is between 2 and 6 kW.</p>
 <p>People</p>	<p>Heat and moisture from people using the cold room.</p>
 <p>Radiation</p>	<p>Solar heat gain. Direct sunshine causes big variation in the temperature of the outside surface. White cladding or painting is best as it reflects radiant heat (see Subsection 4.6.5).</p>
 <p>Floor heating</p>	<p><i>Only for freezer stores:</i> Floor heating is essential if placed directly on the ground as water in the ground below the cold room may eventually freeze and cause 'frost heave' (cracking and buckling of the cold room floor).</p>
	<p>Heat load from the cooling of thermal energy storage packs.</p>

Figure 4.10
Heat loads on a cold room.

4.5 Sizing of cooling plant

Refrigeration plant must be sized for the needed cooling capacity by understanding the cooling load of the cold room, as explained in Section 4.4, adding the various heat loads. Sizing must consider how to address peak loads, and check that the total load over a 24-hour (or longer) period can be met during periods of power availability (assuming energy is not available continually, see also Subsection 5.5.2 on thermal energy storage and its recharge).

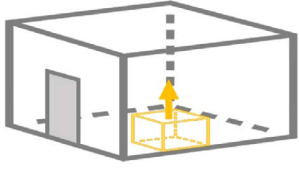
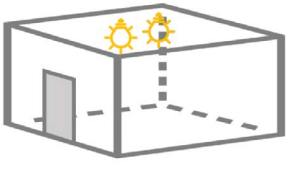
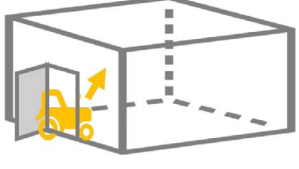
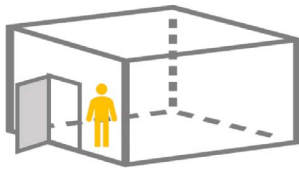
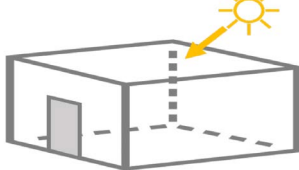
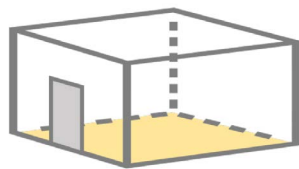
In terms of peak load, a decision is needed on how much of the estimated daily, seasonal and throughput related peak loads the cooling plant must be able to meet. That decision is a trade-off with investment cost and whether the business and operational model enables staff to limit or manage the demand at peak times (e.g. by preventing overloading when temperatures start to stray outside limits). It is possible to use thermal energy storage to meet some of the peak loading (see Section 5.5) as long as there is time beforehand to charge the thermal/energy storage. The variation in cooling demand must be matched with the available stored energy. Use of thermal storage must also consider timing: for example, whether stored energy is used overnight when solar panels are not operational and/or used to meet peak daytime loads – it will not be able to do both unless designed for that. A cooling unit sized to meet peak load may then operate for long periods at a low loading, which makes variable capacity an attractive option to avoid on/off cycling and poor efficiency. Solutions to discuss include using a variable speed (variable capacity) compressor (see Subsections 4.2.1 on system components and 4.3.1 on efficiency considerations), or a modular system with one compressor or cooling unit to meet the baseload and other(s) switched on to meet higher and peak loads.

The total heat demand over a 24-hour (or longer) period must be met during the time that the cooling unit is able to run. The design 'run time' is an important factor in plant sizing. For example, if the unit is only able to run 12 hours per day and the total cooling load is estimated at 48 kWh/day, then the required cooling capacity is 48 divided by 12 hours, which means the refrigeration unit needs to have a capacity of at least 4 kW to meet this total cooling load in the available time. If it is a solar-powered system, the variation of available solar power over that period must be considered in the sizing, and the solar PV modules have to be sized consistently with the power demand of the compressor (see Subsection 5.5.3). The power demand of the refrigeration system is the most important component of the total electrical demand of the cold room, as described in Section 4.7.

This detailed balancing exercise should be discussed with suppliers and consider how cooling demand varies, the cost of components and the operating costs.

Some indicative cooling capacity figures are included in Table 4.1. The refrigeration capacity figures are influenced mainly by the climate in which the cold room operates: lower numbers apply for moderate climates; higher numbers for warmest times of year and in warm climates of lowland tropics or semi-arid regions.

Table 4.1

Approximate refrigeration capacity for small scale cold rooms. *Source: Thompson J.F. and Spinoglio M., 1996.*

Size of cold room (m ²)	Storage capacity (MT)	Range of refrigeration capacity (kW)	
		Target = 1°C	Target = 13 °C
10	3	3.5	2.6
20	6	5.3-8.8	3.5-5.3
40	12	12.3-14.1	7.0-10.6
60	18	17.6-22.9	10.6-14.1
80	24	22.9-29.9	14.1-19.4
100	30	26.4-35.2	15.8-24.6

4.6 Considerations for design of the insulated structure

4.6.1 Design of the insulated envelope

A well-insulated cold room requires less electricity to keep produce cool, reduces running costs and increases the chances of maintaining optimum temperatures. The rate of heat gain depends on the thickness and type of insulation and there is an economic trade-off between the thermal performance, integrity of the room and the operating cost of the refrigeration system – this section introduces ways to quantify that. There are also direct environmental impacts of most commercially produced insulating foams (see below).

Leave a clearance of at least 100 mm between the walls of adjacent cold rooms and other structures so that air can circulate and dry any condensation. Otherwise, moisture will degrade materials and cause future problems. If separate cold rooms are needed close to one another it is better to use a partition wall inside a larger insulated enclosure (see Part 6, “Installation and commissioning for more advice on siting the structure”).

The minimum recommended specifications for the thermal resistance of walk-in cold room structures are:

- Insulation panels for walls, ceilings and doors are to have at least 4.5 m²K/W, which equates to 100 mm polyisocyanurate (PIR) or thicker than 140 mm expanded polystyrene (EPS).
- Minimum thermal insulation ratings on floors of at least 4.9 m²K/W for all cold rooms.
- Any transparent windows and doors to have double-glazed insulating glass units (IGUs) on cold rooms; all IGUs to have heat-reflective treatment and gas fill.
- Proper non leaking sealing of joints of insulation panels, types of doors and door gaskets.

Insulated structural sandwich panels for commercial cold rooms are typically made of expanded plastic foam (often expanded polystyrene (EPS), but others are available) covered on either side by hot-dipped zinc-coated steel sheeting with a food-safe plastic coating (Figure 4.11). Examples and the thermal conductivities of materials are given in Appendix 1, Table 4.4.

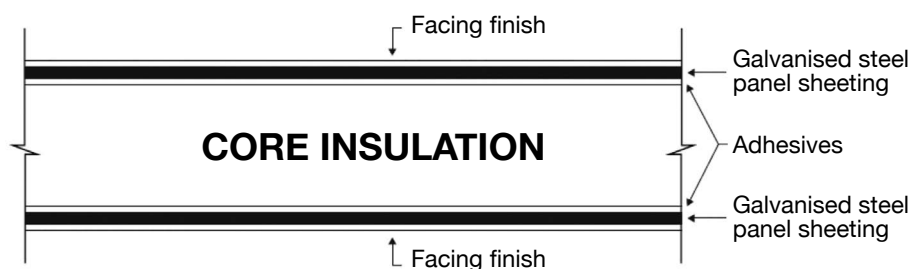

Figure 4.11

Typical insulated sandwich panel cross-section.

Traditional commercial insulation materials contain bubbles filled with air or other ‘blowing agents’ to reduce their thermal conductivity. Some blowing agents still in use in developing economies contain molecules classified as Ozone Depleting Substances (ODS) and have a medium to high GWP such as the R-141b (GWP₁₀₀ 860; ODP 0.11). The blowing agent gases are slowly released to the atmosphere as the plastic material of the foam structure breaks down. The released blowing agent contributes to global warming and, if an ODS, will damage the ozone layer.

The only way to avoid total release of these blowing agents to atmosphere is by processing them in a safe foam destruction facility at their end of life. But there are few, if any, such facilities in emerging economies and collection of foam materials is extremely challenging at scale.

As an example, the insulation foam of one standard small cold/freezer room with storage volume 14 m³ could contain 6.3 kg of the blowing agent R-141b, equivalent to around 4.9 tons of CO_{2e} direct global warming impact, as well as ozone depletion impacts.

Climate-friendly insulation materials use no ODS with ultra-low to zero GWP blowing agents, most commonly cyclopentane (C₅H₁₀), which has GWP₁₀₀ 11. Other ultra-low to zero GWP blowing agents include pentane, isopentane, water-blown or liquid CO₂. Many foam producers have already converted or will convert in near future. Some newer generation insulation panels contain blowing agents like R-1234ze, with an ultra-low GWP but potentially harmful impacts from chemical decomposition (see Section 4.8). As cheaper alternatives to prefabricated structural insulation panels, ordinary expanded polystyrene sheets are often chosen or natural materials can be used if the circumstances are right or there is a significant ambition to reduce waste-related environmental impacts (GIZ, 2019). Natural materials such as straw bales, wool or rice husk can rarely match the thermal and structural performance of prefabricated insulated panels and so must be thicker to achieve the same insulation effect; other considerations apply including how rapidly insulating properties degrade over time, protection from moisture and (for some materials) insect or mould infestation. Annex 1 also includes some natural materials for comparison.

Key considerations for the insulated envelope are:

- Insulation must be kept dry to be effective, so the vapour barrier is very important (see Subsection 4.6.2). Sealing against water used for cleaning is essential.
- Specify thermal performance according to the recommendations above.
- Paint the roof and exterior walls white or a light colour (Thompson, 2001) (see also Subsection 4.6.5).
- Design the roof to shed water and dirt; ensure no puddles of water will remain there as these will find ways to penetrate and ruin the insulation.
- Concrete floors should include a layer of insulating material, and be thoroughly sealed against water from floor puddles, washing and efforts to increase humidity. Water ingress can greatly increase heat leakage (HIA, 2022).
- The internal ceiling of the cold room should completely seal off the roof space to protect against dust and pests.
- Avoid or minimise thermal bridges (ways for heat to enter the structure) such as via any metal components (pipes/cables/brackets) and air paths that pass through the insulation. There are well-established good practice ways to avoid thermal bridges, advice is available from panel suppliers and the codes of practice of refrigeration professional associations (notable sources include the UK Institute of Refrigeration, ASHRAE in the USA and AIRAH in Australia).
- If panels are stored on site, they should be protected from wet, heat and sunshine.

Instead of using self-supporting panels, larger cold rooms (depends on design and shape, but indicatively over 80 cubic metres) may be constructed with a separate structural support as either:

- An internal insulation system with partial external wall cladding. The insulated panels are fitted to the inside of a structure, which also supports the roof and such wall cladding as may be required. Where the insulated wall panels are integral with a weatherproof outer covering, separate cladding is not required.

- An internal insulation system with full roof and wall cladding. The insulating panels constitute either a self-supporting structure to form the complete chamber or insulating panels are fitted to a structure which supports the panels. Such cold rooms are constructed within much larger buildings or, externally, under a weatherproof cover.
- An external insulation system. The panels are fitted to the outside of the structure or racking system and are suitably protected from the weather. The panels also form the base for the roof weather protection which may comprise the panels themselves with all joints fully weatherproofed or roofing materials applied directly to the panels. This system is often called a Clad Rack Design.

See also Subsection 6.2.3 for advice on practicalities of assembly of the insulated panel structure.

4.6.2 Vapour seal of the insulated envelope

The vapour barrier must prevent moisture getting into insulation panels and structure as this rapidly degrades thermal properties and can cause corrosion leading to structural failure. Water ingress will increase the load on the refrigeration system and reduce its efficiency. As insulation is difficult and expensive to repair, especially as the cold room is out of action during repairs, effort to ensure a good vapour seal is a good investment.

The insulation envelope should be vapour sealed on its outside (warmer) surfaces so that water vapour in the atmosphere is not drawn into the panels to condense due to the cooled space inside. Design of joints varies but a typical arrangement is shown in Figure 4.12.

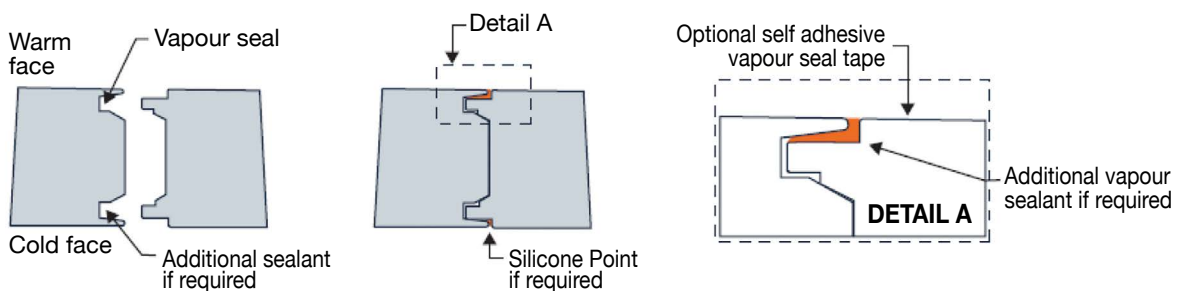

Figure 4.12

Typical panel-to-panel joints.

The panel areas with sheet metal facing are impervious to water vapour and the types of joints shown in Figure 4.12 should be sealed but an additional vapour barrier tape may be applied along the outside of the joint line. Joints to other walls or ceiling panels or floor should be carefully sealed. A very high standard of sealing between panels is required.

The inside of the insulated envelope should not be sealed as any water vapour that does infiltrate the external barrier can be drawn from the insulation into the cold room where it will do less harm. There may be a hygiene requirement to have smooth waterproof and cleanable surfaces on interior walls but ceiling panels are normally exempt from this.

If pipes, cables, cooler supports, light fittings are passed through insulation panels, then the holes must be sealed, as well as holes for surface-mounted equipment such as conduit, cable trays, etc. None of those features should pass through any panel joints or supporting structure. Understanding of this must be ensured for all technicians working on the store.

The joint including the vapour seal must:

- Accommodate movement of the structure (e.g. from thermal expansion and contraction) without compromising the joint.
- Use a sealant with good adhesive and ageing characteristics; suitable for the temperature range of the store; compatible with the materials used in the panel and joint; and does not taint food.
- Be repairable without dismantling the panels.
- If exterior, be resistant to ultraviolet degradation.

4.6.3 Minimising heat loss through the door(s)

The way cold room doors are designed, managed and maintained has a large impact on energy use. The duration, width and frequency of door opening, all lead to greater heat load entering the room. Most walk-in cold rooms will have one access door which may be hinged, sliding, swing or a roller shutter. Key considerations are:

- Consider transparent plastic strip curtains to reduce heat ingress (Figure 4.13). Curtains must be cleaned regularly, especially if unwrapped food is moved through the strips as dirt will get transferred to food. Strip curtains may get condensation forming on them and can soon become scuffed and difficult to see through or broken.
- An electrically driven air curtain can be effective if very regular or almost constant access is needed. Air curtains provide a jet of air, generally from the top, but can also be from the side. Air curtains must be correctly specified and fitted to achieve good effectiveness as a badly fitted or non-suited air curtain can be worse than an open door by pushing air where it is not wanted.
- Monitor door openings to help spot problems and raise staff awareness, using a leaf switch or similar.
- Mechanical devices or springs that assist self-closing and prevent the door remaining ajar reduce energy losses and help maintain temperature.
- A door switch device can control power to installed devices such as pausing fans when the door is open and cutting main lights when the door is closed (emergency lighting must remain).



- Specify good door seals and insulation of the door itself, using panels of the same thickness or thermal performance as the cold room walls.
- Doors may need heaters to stop condensation which can form around the seals and lead to hygiene concerns.
- Damaged door seals, poorly maintained door protection and poor door discipline all add to energy use and can easily be improved by regular maintenance and operator training.

Figure 4.13

Transparent plastic strip curtain applied to a cold room door (*Solarcool*).

4.6.4 Protect insulated panels from impact damage

Most types of insulated sandwich panels can be easily damaged or punctured by impact of heavy and sharp-cornered boxes, machinery or trolleys. This leads to water penetration, less effective insulation and, potentially, mechanical failure of the panel. Plan how to protect panels from scuff and impact damage during construction and in operation when moving goods and boxes around inside and outside, especially if trolleys or trucks are used. Consider kick-plates on lower parts of wall panels and/or kerbing so trolleys do not hit walls. This should be incorporated into the standard operating procedure.

4.6.5 Design to minimise solar heat gain

A hot outer surface drives more heat through the insulation. Figure 4.14 shows how the temperature of a black roof surface might be over 80°C in 37°C air temperature under clear skies, whereas a white roof surface would be at only 45°C. This is due to a combination of how the surface reflects solar energy (reflectance) and how it emits the solar energy that it has absorbed (emissivity)⁶. These can be combined into a Solar Reflectance Index⁷. Whilst many factors affect the actual

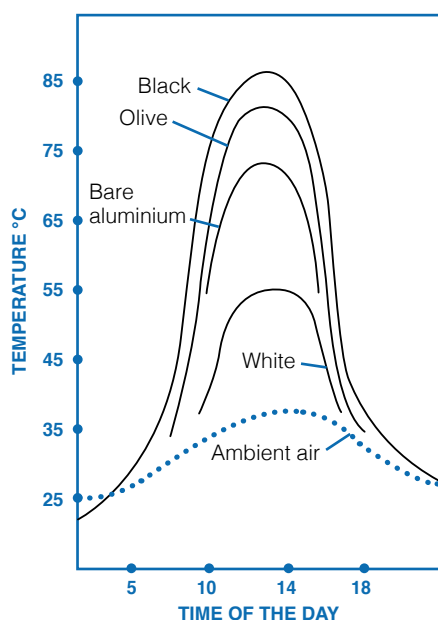

Figure 4.14

Typical panel surface temperatures arising due to solar exposure (Source: ASHRAE Handbook Fundamentals).

impact of the situation, since heat gain is directly proportional to temperature difference across the panels, this could mean in theory that the white surface gives as little as half the transmission losses of the black one for the panels facing sunwards when at peak solar gain, given a 5°C storage temperature. In addition, solar gain and day/night temperature variations cause expansion and contraction of panels and stress the joints to cause vapour barrier leaks.

Hence, in tropical and hot climates sun shading on top and sunward sides of a cold room is essential. This is often provided at least partially by any photovoltaic panels. Shiny white is an excellent choice for the colour of the outer skin of the cold room due to low emissivity and reflecting radiant heat.

4.6.6 Considerations for self-built cold rooms

Prefabricated cold room kits are relatively easy to assemble and should perform reliably if they are properly specified for the location and application but they are generally expensive and may not be available for delivery far from large towns. Locally available materials might be used to self-build small cold rooms for specific use cases and are excellent ways to use local skills and materials.

⁶ Surfaces with low solar reflectance absorb a high fraction of the incoming solar energy and some of that is conducted into the insulation panels. Surfaces with low emissivity cannot effectively radiate to the sky and, therefore, get (and stay) hot.

⁷ See ASTM E1980 Standard Practice for Calculating Solar Reflectance Index of Horizontal and Low-Sloped Opaque Surfaces. Available from <https://www.astm.org/e1980-11r19.html>

This should be feasible for short term storage applications at down to 10°C, with lower temperatures possible but challenging maintain without experience and a good design. Considerations for self-built systems include:

- The outside surfaces of the cold room can be made of galvanised steel or aluminium. Selection depends on needs for toughness, brightness of colour, ease of cleaning, or perhaps some requirement to satisfy local sanitation standards.
- Fast-acting doors that slide horizontally help minimise opening and closing time consequently reducing the heat load. This can be paired with vertically hung plastic strips.
- Quality of panels should be checked for uniform shape and appearance, tight joints, surface coatings, latch mechanisms, and homogeneous insulation.
- All lining materials for the insulated enclosure should be food grade.
- Semi-hermetic compressors, when available of the right size and affordable, are easier to maintain than hermetic compressors since their interior is accessible.
- Capillary tubes are a simple and reliable expansion device to use in small refrigeration systems.
- All fire protection matters should be discussed with and approved by the local Fire Prevention Officer.
- Air conditioning units can be adapted and applied to cool a small cold room as a low-cost way to provide cooling. There are kits commercially available to 'trick' conventional AC controls into operating for longer periods, enabling achievement of lower temperatures⁸. However, by doing this there is a greater chance that the evaporator will ice up. Modified air conditioner systems tend to lack the cooling capacity to remove heat from products – a separate precooling system with higher cooling capacity would thus be essential – but can be adequate for maintaining a chilled temperature if cold room insulation levels are good.

Bear in mind that any cooling and electrical system as well as the monitoring one will need maintenance; involving local technicians in a self-built cold room project from the outset builds capacity to provide longer term service. Capacity building can be combined with college-based training as increasing numbers of colleges and training centres are offering such courses. Local assembly and manufacturing of cold rooms helps create a more stable local supply chain, providing jobs to the community, and should therefore be considered.

4.7 Estimating the electrical power requirements of the whole system

To size the grid connection, solar photovoltaic system or other sources (which is explained in Part 5), it is necessary to estimate both the average electrical load (kW) and the average daily electrical energy use (kWh). In a similar approach to that of the heat load estimate (see section 4.4), it is necessary to estimate the electrical load associated with the 'Design Day' loading as well as the 'Peak of the year' loading. As explained in section 4.4, the 'Design Day' is a judgement of loading that balances the available cooling capacity against the investment cost. It is also worth checking that the system can properly address the 'Average Day' and 'Low Day' demands.

⁶ See for example the project by Smart Villages Reseach Group in Uganda: <https://storage.googleapis.com/e4a-web-site-assets/Innovator-Series-SVRG.pdf>

The electrical loads that contribute to the total are listed below; as with the heat loads, consider carefully which could be simultaneously in use and so contribute to a total maximum load at any given time:

1. Consumption of the refrigeration system itself. This could be either:
 - a. Monobloc cooling unit(s), in which case, look up the rating plate or technical specification to find the maximum rated input power. If variable capacity, then the data sheet should show power at various proportions of full capacity so that an average could be estimated using the heat demand profile which is dependent on the produce being stored. Or:
 - b. If a custom system is being specified, then add up the power of cooling equipment components:
 - Refrigeration compressor, compressor pack or condensing unit. Look up the rated input power for the envisaged temperature duty from the technical specification; use the rated electrical input power of the condensing unit at the envisaged temperature and duty. Alternatively, the power can be estimated using the cooling capacity and an assumed or calculated coefficient of performance (COP), knowing that $COP = (\text{delivered cooling capacity, kW}) / (\text{input power, kW})$.
 - Condenser fan motors if not included above, adding up the total peak input power of the motor(s).
 - Evaporator fan motors.
 - Electrical defrost heaters, if fitted/used (see Subsection 4.9.1).
 - Other loads directly associated with the cooling plant.
2. Any door seal heaters, anti-condensation heaters.
3. Lights (see Subsection 4.9.1).
4. Control systems, monitoring equipment such as temperature and humidity sensors, data loggers, PC, readout screens, communication equipment for data transmission (see Section 4.10).
5. Charging of electrical batteries, if any.
6. Other loads such as sockets used by staff and others for computers or phone charging, other battery chargers, power tools, lifting equipment, scales for produce weighing, etc.

Most electrical loads can be simply identified from the manufacturer's information or labels on the components. Generally, the refrigeration compressor accounts for most of the electrical load (at least 60%).

Ideally, the information given to the electrical system engineer would include:

- Load name (e.g. compressor).
- Quantity of identical loads (e.g. 3 identical LED lamps).
- Voltage required (e.g. 230 VAC, 48 VDC).
- Required number of phases (i.e. single phase, three phase).
- Required input frequency (e.g. 50, 60 or 50/60 Hz).
- Electrical power (i.e. kW, Watts, $V \times A \times \cos(\phi)$).
- Current in amps (A).
- Starting current or peak inrush current for motors or compressors in A (e.g. quote the full load current and, if available, locked rotor current, or surge power requirement in VA).
- Power factor of the equipment.

The load to charge electrical batteries would be significant if batteries are used for full autonomy of the system during periods without power input (i.e. powering the refrigeration system and all equipment). If batteries are only used for monitoring equipment and boosting power for motor start-up, this load will be minimal (a few tens or hundreds of Wh per day). The battery capacity and its typical daily (dis-)charging cycle is decided after calculating the required system autonomy (see Subsection 5.3.3). Once that is decided, a more accurate figure for the battery charging electrical load will be known.

This information is needed to specify the electrical supply system properly to ensure the right supply at optimum cost (see Part 5).

4.8 Refrigerant selection

Refrigerant selection is an important issue in terms of environment, safety and efficiency. This section summarises the main types of refrigerant on offer and the factors to be considered when requesting or specifying refrigerants. The decision on which refrigerant is a compromise based on many criteria that vary by application. Whilst some suppliers may provide a system designed to operate on any one of two or three different refrigerants (perhaps enabling a late choice depending on local availability), the design should ideally be optimised for a specific refrigerant to get best efficiency and performance – achieving that flexibility inevitably means making compromises.

All greenhouse gases (GHG) are classified by their Global Warming Potential (GWP), which is an index of the radiative forcing of the GHG following its emission, accumulated over a chosen time horizon, relative to that of carbon dioxide (CO₂). The GWP figure thus represents the combined effect of the differing times the substance remains in the atmosphere and its effectiveness in causing radiative forcing (IPCC, 2021). Due to the urgent need for effective action in the short term, policy focus is shifting from the previously used GWP on a 100-year horizon (GWP₁₀₀) and onto GWP₂₀ on a 20-year horizon.

In general, options fall into one of two classes of refrigerant, synthetic containing fluorine and natural.

4.8.1 Synthetic refrigerants containing fluorine

Among synthetic refrigerants containing fluorine, the most widely available are HFCs (hydrofluorocarbons). Commercially available walk-in cold room units that serve both chilled and frozen applications have historically used R-404A, which is an HFC blend with very high GWP. R-404A is now a poor choice, given the widely available alternatives. Some HFCs are single component fluids (e.g. R-134a, R-125 and R-32); many are blends of other fluids (e.g. R-404A, R-410A). Most HFC refrigerants have an A1 safety classification (non-toxic, not flammable, see Figure 4.15) but many have high or very high GWP (Figure 4.16 and Table 2). HFC use is regulated in many developed countries and is increasingly regulated in developing countries. HFCs or HFOs with lower GWPs are available but many are mildly flammable (A2L category, see Figure 4.15) and need safety assessment and careful system design. A potential factor against HFOs is that some of them might convert into trifluoroacetic acid (TFA) in the atmosphere, a highly durable chemical that can have negative effects on organisms, ground and drinking water and human health, according to recent studies (UBA 2021). Note that synthetic refrigerants containing chlorine (CFCs and HCFCs) are no longer a sustainable option due to their ozone depletion impacts (they are ODS) and are being phased out worldwide under the Montreal Protocol. HCFCs are now banned in most developed countries, both for the manufacture of insulation and in refrigeration

systems, and they should not be used as much better alternatives are available. CFCs include R-11, R-12, R-502; HCFCs include R-22. The ozone depletion potential (ODP) of any refrigerant specified should be zero.

4.8.2 Natural refrigerants

These match chemical compounds that exist in nature. The most common being a range of hydrocarbons including propane (R-290), propylene (R-1270) or isobutane (R-600a). Hydrocarbons are efficient and non-toxic, but they are flammable and so generally classed as A3 in Figure 4.15. Their major benefit is an ultra-low GWP of less than 3 (Figure 4.16). Generally, due to flammability and safety issues, hydrocarbons are more suited to smaller refrigeration systems such as household and small commercial systems, including ‘monobloc’ (single package) refrigeration systems used on most small walk-in cold rooms, since these have refrigerant charges of only up to a few hundred grams. Charges up to 5 kg of hydrocarbons are used in water chillers or heat pumps mainly for outdoor installations, with specific safety controls. Other natural refrigerants include carbon dioxide, used in commercial systems in mild climate conditions, which requires complex engineering to improve its intrinsically lower efficiency, and ammonia, which is used in large and industrial refrigerated stores but requires careful design and operation due to its toxicity.

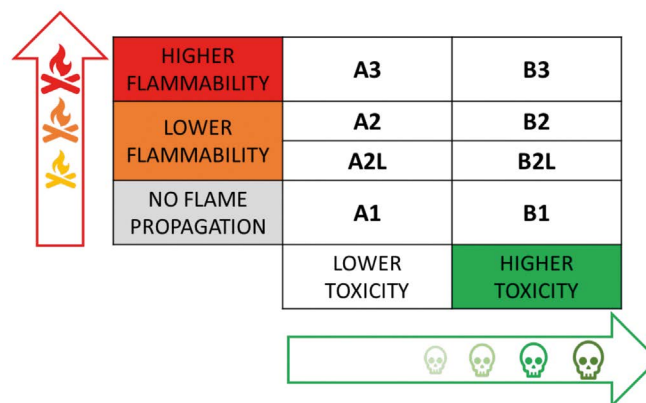

Figure 4.15

Illustration of how categorisation of refrigerants by flammability and by toxicity is organised A2L refrigerants have lower flammability with a maximum burning velocity < 10 cm/s. (ISO 2014, ASHRAE, 2019).

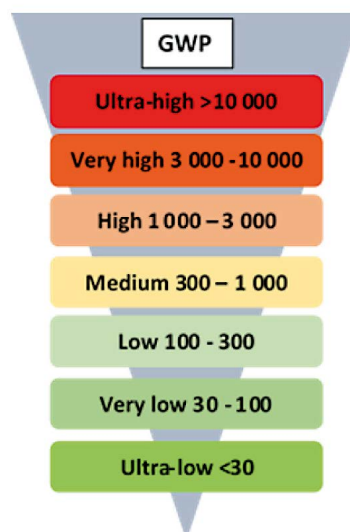

Figure 4.16

Classification of common refrigerants according to their level of global warming potential (GWP). (Source: UNEP OzonAction Kigali Fact Sheet 3).

Considerations in choice of refrigerant include:

1. Refrigeration system availability: HFC based systems are freely available. Virtually all suppliers can provide equipment with HFO or natural refrigerants with low to ultra-low GWP and transition to these is encouraged, subject to meeting safety and maintenance requirements. All major manufacturers of monobloc cooling units have R-290 (propane) models in their ranges – these are not complicated and technicians can be trained for their installation in a few hours.
2. Capital cost of the system: Systems for natural refrigerants are currently slightly more expensive than for R-134a to address safety and other issues but have mitigating factors as below. The costs of HFC refrigerants will rise as their phase-out proceeds and quotas start to restrict availability.
3. Energy efficiency in operation: Higher efficiency means lower running cost for grid power usage, or, for solar powered systems, smaller batteries, possibly a smaller PV module array and more cooling per kW of solar irradiation. R-134a enables around 10% better energy efficiency than R-404A but natural refrigerants enable a further 5% to 10% better efficiency.
4. Environmental and climate impact: In terms of the direct impact of their chemicals on the environment, refrigerants with long term sustainability should be selected that have zero ODP, low or ultra-low GWP because pipework and connections in a refrigeration system have potential to get damaged and leak, or refrigerant is released when the system is decommissioned. However, in almost all systems that draw power from a grid, far greater global warming impact is caused from generation of the electricity to run the equipment than from direct impact of the refrigerant. This means that energy efficiency (see above) is a major factor in overall impact for those systems, as demonstrated by calculation of Total Equivalent Warming Impact (TEWI) of refrigeration systems, which combines the direct and indirect impacts into a single figure (AIRAH 2012). Note that in many cases, natural refrigerants with ultra-low direct impacts also offer very good energy efficiency of the cooling unit.
5. Access to top up refrigerant: HFC refrigerants are freely available in almost all countries; R-600a is available in around 95% of countries (because of its use in almost all household refrigerators); R-290 is not so widely available but in countries that already have commercial refrigerators using R-290 will be generally accessible. Sales representatives in most countries will have natural hydrocarbon refrigerants or can get them when needed. Bear in mind that typical, small cold rooms that are the subject of this guide use monobloc cooling systems which are hermetically sealed and should not need any top-up of refrigerant unless pipework or sealed components are damaged and the refrigerant leaks out.
6. Safety considerations: The refrigerant selection must take account of local safety regulations. Other than asphyxiation if released into confined spaces, there are few direct safety implications for HFC refrigerants but hydrocarbon refrigerants such as R-290 and R-600a are highly flammable, and design and use restrictions usually apply.
7. Any restrictions on shipping equipment with flammable refrigerants: Monobloc systems using natural refrigerants most often used for small walk-in cold rooms contain only around 150 g of R-290; thus, shipping rules are similar to those for household refrigerators with R-600a. There is generally no problem for transportation of these by road, rail or ship, although some expectations seem to persist that local interpretation of rules can vary. Air shipment is far more likely to bring complications for natural and many low-GWP refrigerants as the refrigerant may need to be removed before the flight and then recharged in the destination country. Shipping companies will know the local rules, which vary for each country. (See also Part 6 Installation and commissioning on shipping of equipment).

8. Planning constraints: Local authorities may place restrictions on use for some system types; seek local guidance.
9. Total cost of ownership: A calculation should be made to combine system purchase cost (taking account of smaller battery and PV systems for highly efficient plant) with lifetime running costs, including maintenance and availability of refrigerant, and spare parts into the future. Comparison can then be made on a fair basis.

Detailed guidance on refrigerant issues is available from the following sources:

- UNEP Ozonaction initiative.
- Proklima Green Cooling Initiative.

Table 4.2

GWP values for relevant conventional and climate-friendly refrigerants for solar cooling systems (adapted from IPCC 2021).

Refrigerant	Type	GWP20	GWP100
R-22	HCFC	5690	1960
R-32	HFC	2690	771
R-134a	HFC	4140	1530
R-404A	HFC blend	7208	4728
R-410A	HFC blend	4715	2256
R-452A	HFC blend	4273	2292
R-449A	HFC-HFO blend	3321	1435
R-717 (ammonia)	Natural	<1	<1
R-744 (carbon dioxide)	Natural	1	1
R-290 (propane)	Natural – Hydrocarbon	0.072	0.02
R-600a (isobutane)	Natural – Hydrocarbon	0.022	0.006
R1270 (propylene)	Natural – Hydrocarbon	<1	2

4.9 Considerations for ancillary systems

4.9.1 Defrosting

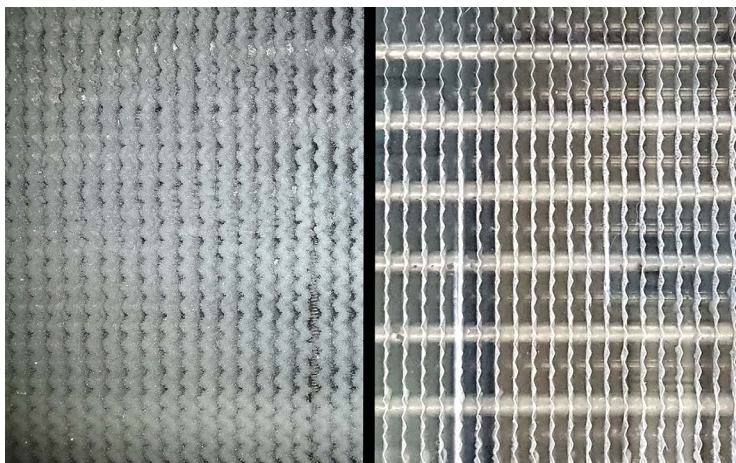

The evaporator surface is subject to frosting when humid air is cooled and the surface temperature is below 0 °C (Figure 4. 17).

Figure 4.17

Comparison between frosted (left) and defrosted (right) evaporator surface (air cooling coil).

If removal of frost from evaporators is required it can be done by passive means, electric heaters or using hot gas piped from the compressor discharge, or by reversing the refrigeration cycle. Passive off-cycle defrosting can be used in chillers. The refrigerant flow to the evaporator is stopped but the evaporator fans continue to operate. Provided the air passing over the evaporator is above 0°C, the frost and ice can then melt, depending on sufficient temperature difference between the air and the frost/ice. Frequent off-cycle periods and defrosts are required to enable such a system to be effective. Electrically operated resistive heaters are often used to defrost smaller cold rooms but are not efficient and represent a heat load on the cold room (see Section 4.4). Hot gas systems use heat from the compressor that would otherwise be wasted and are a smart way to defrost with gas passing through the evaporator pipes to melt ice.

Water melted during defrost need to be drained to outside of the facility. This is achieved by pipes connected from the defrost drain pan (under the evaporator) to an external drain.

For chilled rooms the cheapest and simplest option is to operate a passive defrost. However, care must be taken to ensure that the ice is melted at each defrost. Ideally the refrigeration system should operate cyclically, and the ice should be melted during each off cycle. The defrost itself should be a safety feature and should not really be required (as the defrost should be terminated on a temperature and not a time the actual defrost will be relatively short if ice is not present). If the off-cycle period and defrost are not sufficient ice will gradually build up and block the evaporator. This will prevent air being distributed within the store. Under some circumstances this could cause issues with liquid refrigerant not being boiled off in the evaporator and returning to the compressor (which will result in damage to the compressor). The number of defrosts required per day will depend on the produce stored (e.g. its transpiration rates), the level of infiltration of outside air into the cold room and its humidity content. When operating a passive defrost system it is preferable to schedule regular defrosts. Defrosts should be controlled using a temperature sensor embedded in the evaporator block. The termination temperature should be set in the controller to a value > 0°C and this value should be checked by manual examination to make sure all ice is being removed from the evaporator. If ice is present after a defrost, the defrost termination temperature should be increased.

For chillers that do not operate continually a defrost can be applied once the food has been cooled and moved into a cold store. Often some level of ice will be present on the evaporator, but if the chiller is switched off for several hours, this is not an issue as all ice can be removed during the off period.

4.9.2 Lighting

In cold rooms the lighting energy is paid for twice, first in the power used by the lights to illuminate the room and, second, in the energy required by the refrigeration plant to extract the heat generated by the lights (see Section 4.4). LED lighting is very efficient, generates far less heat and, because light is instant even in cold conditions, can be switched on and off as needed (most other types need time to warm up before they give full light output). Sensor-controlled LED lights that operate only when staff are nearby are worth considering.

4.9.3 Pipework

Site-built refrigeration systems require liquid and suction lines to be connected. These join to direct expansion outdoor condensing units or consists of hydronic pipework in the case of secondary refrigeration systems between the chillers and indoor room coolers. Quality of brazed or mechanical joints is critical to eliminate refrigerant leakage. In direct expansion systems, only the suction lines returning from the evaporator to the compressor require insulation.

For secondary refrigerant pipework, both supply and return lines must be insulated (Figure 4.18). Insulation of pipework reduces energy loss and improves compressor efficiency. Insulation is ideally flexible, closed-cell nitrile rubber with thickness typically:

- For 15-20 mm pipes: 25 mm insulation.
- 28-40 mm pipe: 32 mm insulation for pipes at < 2°C and 25 mm of insulation for pipes > 2°C.



Figure 4.18
Pipework insulated with flexible foam.

4.9.4 Pressure relief for the cooled space

When air is cooled its pressure drops, and if the pressure cannot equalise in an enclosed volume (such as a well-sealed cold store), it can result in high loads on the panels and structure, plus the door may become difficult to open. In extreme cases, the internal panels or cladding may detach or collapse. All cold rooms should allow pressures to be safely equalised using purpose-designed pressure relief valves and/or door gaskets.

The size of the vent area can be calculated by using the following equation:

$$A = \frac{0.063 Q}{\sqrt{(T + 273) \Delta P}}$$

Where:

A = Required vent area (m²)

Q = Rate of heat production or extraction in the chamber (kW)

T = Temperature in chamber (°C)

ΔP = Allowable design pressure difference between interior and ambient.

A typical value of ΔP is 125 N m⁻².

Vent needs might be equivalent to a circular diameter of 40 mm up to 120 mm or beyond, depending on the factors in the formula. For small stores, especially in humid or tropical climates, the vent area should be increased from the formula by a factor of around 2 to account for greater cooling/heating rate relative to the room volume and fewer doors.

4.9.5 Ventilation

Ventilation may be necessary because fruits and vegetables respire and metabolise which generates carbon dioxide, ethylene and heat. The level of respiration depends on the product type, storage temperature and maturity of the produce. Without ventilation oxygen levels can drop, which can result in anaerobic respiration and quality problems; small quantities of ethylene (the ripening hormone) can also have significant impacts on the quality of produce. For these reasons, ventilation is essential to maintain the quality of produce. Whereas excessive ventilation adds additional heat load to the room and should also be avoided (see Subsection 2.3.4).

4.9.6 Control of ethylene gas levels

The sources and impacts of ethylene are described in Subsection 2.2.4. For high ethylene producing fresh fruits and vegetables, ethylene can also be absorbed or scrubbed on commercially available potassium permanganate pellets or activated charcoal (Kitinoja and Kader, 2015). Ethylene is oxidised by potassium permanganate (KMnO_4) packed in sachets placed in boxes or via use of filters placed in the air recirculation systems in cold rooms. The potassium permanganate must be changed regularly and disposed of safely. Ozone generators or photocatalytic converters have also been used to reduce ethylene concentrations in the cold room (Keller et al., 2013), and can be cost effective if ethylene buildup is causing issues with produce quality.

Separate storage of ethylene sensitive commodities from those that produce ethylene may be difficult to achieve where space is limited and mixed loads are common. In this case, enough fresh air should be introduced into storage rooms to keep ethylene level minimal. Unless outside temperatures are very low or very high, ventilation is an inexpensive method of reducing ethylene levels in the storage room (see Subsections 2.3.4 on management of fresh air exchange and 2.3.5 on ethylene control).

4.10 Monitoring systems for performance of store, cooling plant and the business

4.10.1 Overview of the approach to monitoring

Monitoring of the condition of stored produce and equipment performance is essential to run an effective, efficient and reliable cold room business. This section describes the technical monitoring options for which hardware is needed as part of the system design and this is mostly used to assess the technical performance of the cooling plant. The qualitative and other monitoring tasks (such as produce throughput) are addressed in Part 7 and in particular in Section 7.8.

A good monitoring regime brings these benefits and more:

- Confirmation to staff and customers that produce is well cared for.
- Predictive maintenance so that component and performance problems are spotted and fixed in a planned and cost-effective way before produce quality is hit (avoiding expensive failure panics).
- Better management of business running costs.
- Historical records enable analysis of historical trends to make good planning decisions on improvement and expansion and valuable in case of breakdowns and optimising the operation of the system, indicating possible savings.
- Accurate and fair invoicing for cooling-as-a-service type business models.

Monitoring reveals the performance of a WICR in two main dimensions:

- 1. Technical performance** (addressed in this section) – how well the WICR performs the function of cooling, i.e. engineering and technical performance of the refrigeration plant and insulated envelope, including energy consumption, achieved air and produce temperatures, autonomy, etc. Particular in-depth monitoring would be valuable during commissioning and subsequent monitoring should compare against the baseline from commissioning, but the main focus is on day-to-day monitoring of the cold room and plant.

2. Operational performance – when combined with business planning, it shows how well the WICR operates in situ and to what extent it is in sync with the intended business model. This requires understanding the operational temperatures and humidities for food quality and business effectiveness; throughput of produce, usage levels, door opening management, costs of running the plant, types of produce stored (to match with temperatures and humidities). And in the case of users being charged per crate of produce per hour or per day you must examine by whom, in what quantities and for how long. Operational performance and monitoring is addressed in Section 7.8.

Note that a third dimension to performance would be to evaluate the impact of the cold room on users and the local community. This is beyond the scope of this guide but would address how well the WICR has delivered its intended socioeconomic benefits to users and the community, avoided food waste, created jobs, boosted revenue of its users, etc. Analysis of this would involve surveys, qualitative investigations, and analysis of produce flows, quality and value.

4.10.2 Technical monitoring of the refrigeration plant and its performance

Two parameters are essential to gauge walk-in cold room performance:

1. Temperature in the cold room for produce quality. The most basic monitoring requirement is regular temperature checks to maintain the quality of the stored produce. Easy-to-read and accurate thermometers are needed that must be placed at locations representative of the main body of circulating air (e.g. away from corners) and, ideally, should be calibrated annually (at the least, by immersing in an ice/water mix and verifying 0°C is shown (see Subsection 7.10.3). Dial thermometers are generally reliable and easy to read but have no data logging capability. Three of the approaches are shown in Figure 4.19.
2. Energy consumption of the cold room equipment to assure economic sustainability and warn of technical problems. Sub-metering of selected subsystems or components may be worthwhile.

Keeping records of measurements is essential for optimising performance and quality. If staff are on site, pen chart recorders (daily/weekly logs) are one option to manage and interpret them. Electronic portable data loggers of widely varied sophistication and price are available⁹, which enable local and remote access (depending on data connections)¹⁰ (See Subsection 4.10.5). Many suppliers offer remote phone app-based control and monitoring software which enable users to check performance of the facility and adjust setting remotely.



Figure 4.19

Temperature monitoring equipment takes many forms: a computerised system (left, *Inspirafarms*); occasional manual monitoring of core temperature of produce (centre, *Inspirafarms*); simple and reliable analogue dial thermometer (right, *Solarcool*).

⁹ *Field Testing of Appliances Suitable for Off- and Weak-Grid Use, Generic guidance on appliance performance monitoring in the field, Efficiency for Access, January 2022. Available from <https://efficiencyforaccess.org/publications/field-testing-of-appliances-suitable-for-off-and-weak-grid-use>. See section 3.2.2 Data Logging Strategy: How and Where the Data is to Be Stored.*

¹⁰ *Examples include: VARCODE smart tags (www.varcode.com), wi-fi enabled sensors (www.sensoscientific.com) and FarmSoft monitoring systems (<https://www.farmsoft.com/traceability/fresh-produce-temperature-control-ripening>).*

4.10.3 Metric for efficiency of the refrigeration system

Theoretical efficiency

The performance of a refrigeration system can be assessed at the design stage to compare alternative designs by calculating the coefficient of performance (COP). The Carnot COP is the theoretical maximum possible thermal efficiency of a 'perfect' system (i.e. thermodynamic transformations are all reversible, which is not feasible) but actual achieved efficiency is always less, due to losses and inefficiencies. Actual COP depends on the equipment selected, the refrigerant used, system efficiency, its design, how the plant is operated and more.

Carnot COP is calculated from:

$$\text{Carnot COP}_{\text{Cooling}} = \frac{Q_c}{Q_h - Q_c} = \frac{T_c}{T_h - T_c}$$

Q = quantity of heat transferred

T = temperature (in degree Kelvin)

h = heating (condensing)

c = cooling (evaporating)

Worked examples:

Carnot COP for condensing at 313K (40°C) and evaporating at 263K (-10°C):

$$\text{COP}_{\text{Cooling}} = \frac{T_c}{T_h - T_c} = \frac{263}{313 - 263} = \frac{263}{50} = 5.26$$

Carnot COP for condensing at 313K (40°C) and evaporating at 253K (-20°C):

$$\text{COP}_{\text{Cooling}} = \frac{T_c}{T_h - T_c} = \frac{253}{313 - 253} = \frac{253}{60} = 4.22$$

A rough estimate of the actual COP can be calculated from:

$\text{COP}_{\text{actual}} = \eta_r \times \text{Carnot COP} \times \text{Isentropic efficiency of the compressor}$

Isentropic efficiency of the compressor varies but is usually within the range 0.5-0.8.

η_r = efficiency of the refrigeration cycle: $\eta_r = 1 - \frac{T_h - T_c}{T_c}$

Worked examples:

For condensing at 313K (40°C) and evaporating at 263K (-10°C):

Carnot COP was 5.26

Taking an isentropic efficiency of the compressor of 0.7

$$\eta_r = 1 - \frac{313 - 263}{263} = 0.81$$

COP actual = 0.81 x 0.7 x 5.26 = 3.0

For condensing at 313K (40°C) and evaporating at 253K (-20°C):

Carnot COP was 4.22

Taking an isentropic efficiency of the compressor of 0.7

$$\eta_r = 1 - \frac{313 - 253}{253} = 0.76$$

COP actual = 0.76 x 0.7 x 4.22 = 2.3

'Real life' efficiency

The coefficient of performance (COP) of the cooling system is most useful when calculated for the whole system which includes fans, lights, pumps, etc. COP is calculated from:

$$\text{COP}_{\text{Cooling}} = \frac{Q_c}{W}$$

Q = useful cooling effect, or heat removed by the system (kW)

W = power demand of all energy using parts of the system (kW)

It is possible to measure the real COP of a system (and compare this to the theoretical value) but this requires detailed knowledge of the system and components, with a pressure sensor on the suction line and temperature sensors on the liquid and suction lines and ideally mass flow should also be measured or estimated. For most situations, this should be discussed with the refrigeration system designer and contractor.

For further reading on efficiency and performance, these publications may be useful:

1. Air-Conditioning, Heating, and Refrigeration Institute (AHRI): 2014 Standard for Performance Rating of Walk-in Coolers and Freezers - [https://www.ahrinet.org/App_Content/ahri/files/standards%20pdfs/AHRI%20standards%20pdfs/AHRI_1250_\(I-P\)-2014.pdf](https://www.ahrinet.org/App_Content/ahri/files/standards%20pdfs/AHRI%20standards%20pdfs/AHRI_1250_(I-P)-2014.pdf)
2. WHO Performance, Quality and Safety (PQS) Specification E001/CR-FR01.4 Cold rooms and freezer rooms.

4.10.4 Technical parameters to be monitored

To optimise the system, the operational performance must be tracked over time using a schedule of daily, weekly and monthly checks and analysis of relevant parts of the data – and taking any corrective action. Important performance parameters to track for WICR are presented in Table 4.3. For guidance on how often temperature and other measurements should be taken (see Section 7.8). Many options for hardware to achieve monitoring of the other parameters are described in the Efficiency for Access guide to field testing off-grid appliances¹¹. Systems can be remotely monitored via GSM data connections or cloud-based technology for system performance and health. Signs of faults or failure trigger efforts to resolve the issue.

¹¹Field Testing of Appliances Suitable for Off- and Weak-Grid Use, Generic guidance on appliance performance monitoring in the field, Efficiency for Access, January 2022. Available from <https://efficiencyforaccess.org/publications/field-testing-of-appliances-suitable-for-off-and-weak-grid-use>

Table 4.3

Parameters for operational monitoring that have hardware needs as part of system design.

Parameter	Description	Key considerations
Internal dry bulb temperature (0C)	Average temperature of the air inside the unit	Sensor location is crucial for useful measurement: Measure at point with free airflow (> 10 cm from corners, 2 cm to 5 cm from wall surface); away from direct blast of the evaporator and not close to the door. Hourly tracking is usually adequate.
Temperature of stored produce at its core (°C)	Actual core temperature inside the items of produce that are stored	This is the most important temperature to estimate, and occasionally measure. Can be achieved using ‘simulated produce’: a thermocouple inside a plastic block or water container of similar size to produce items.
Internal relative humidity (%)	Amount of water vapor present in the air inside the unit	Sensor location and timing of measurements are crucial if data is to be useful. Locate in free airflow. Low humidity can lead to higher drying effect, loss of produce weight and freshness. Hourly tracking is usually adequate.
Ambient dry bulb temperature (°C)	Temperature of the air surrounding the unit	Critical impact on heat load and efficiency of the cooling system – thus useful to indicate changing energy demand.
Ambient relative humidity (%)	Amount of water vapour present in the air surrounding the unit	Higher humidity means more condensation and latent loading on evaporators – this can exceed the ‘sensible heat load’ (temperature drop) under some circumstances. When humidity is high it is even more important to minimise door opening.
Number of door openings per day	How many times a day and for how long the unit’s door is opened	For walk-in cold rooms of < 40m ³ door openings are a critical source of heat and humidity load. Measure them and minimise them.
Voltage applied to refrigeration system (Volts)	Maximum, average, and minimum voltage applied to the system over 24-hour period	Variation of voltage impacts system efficiency and can lead to accelerated motor failure (when more than 10% from nominal). Solar array and battery voltage variations can aid in electricity system troubleshooting.
Current drawn by walk-in unit (A)	Current drawn by all the components that are necessary for the operation of the unit	Necessary to calculate energy consumption (kWh meters automatically measure current and voltage, integrating the energy consumption measurement over time)
Daily energy use (kWh)	Cumulative energy consumption at the end of each 24-hour period	Track how this varies by day and by season to scan for faults and management/workflow problems.
Daily RE energy supply (kWh)	Natural cumulative energy supplied by the renewable energy system	Useful to monitor cost effectiveness of renewable source and scan for faults.
Weather patterns	Daily temperatures, solar radiation, rainfall etc.	These influence plant performance and thus help explain variations in performance.
Ethylene concentration	Ethylene concentration meters can be purchased	Rarely used on small cold rooms (cost effectiveness is limited unless for dedicated storage of produce highly sensitive to ethylene, e.g. kiwi fruit)

4.10.5 Data capture strategy and data loggers

This section contains only a brief overview of these issues. Detailed guidance on data capture, approach to analysis, choice of sensors for monitoring temperatures, voltages, power, etc. is given in example publications by Efficiency for Access Coalition – these are not specifically about cold rooms, but include useful insight on monitoring in the field:

- Field Testing of Appliances Suitable for Off- and Weak-Grid Use, Generic guidance on appliance performance monitoring in the field, January 2022. Available from: <https://efficiencyforaccess.org/publications/field-testing-of-appliances-suitable-for-off-and-weak-grid-use>.
- Designing and implementing field testing for off- and weak-grid refrigerators, Guidance on refrigerator performance monitoring in the field, June 2022. Available from: <https://efficiencyforaccess.org/publications/designing-and-implementing-field-testing-for-off-and-weak-grid-refrigerators>.
- Evaluating appliance performance in the field, results from refrigerator testing, April 2023. Available from: <https://efficiencyforaccess.org/publications/evaluating-appliance-performance-in-the-field-results-from-appliance-testing>.

Once performance parameters to be monitored are decided, the data recording interval or frequency of measurement must be decided for each parameter. Data can be instantaneously measured at regular intervals, at precisely known intervals and times, event triggered or cumulative. This affects the sensor types chosen, data storage, cost and ease of analysis. Choose the lowest frequency consistent with needs to avoid high equipment costs and time for data processing. For temperature monitoring a reading every five or ten minutes should be more than adequate, but consider having several temperature sensors to monitor heat distribution vertically and horizontally, plus outside ambient (sensors are relatively cheap).

The main elements of a monitoring and logging system are:

- Sensors: to measure performance parameters and transmit for storage.
- Communications: to receive data from sensors and deliver it to storage.
- Data Logging: how data is recorded, dated/time stamped. Can be in person from the site, at intervals or at end of the monitoring period; remote collection using data loggers with data network access and cloud storage; local storage, for example on microSD card – or a mix of these (Figure 4.20).

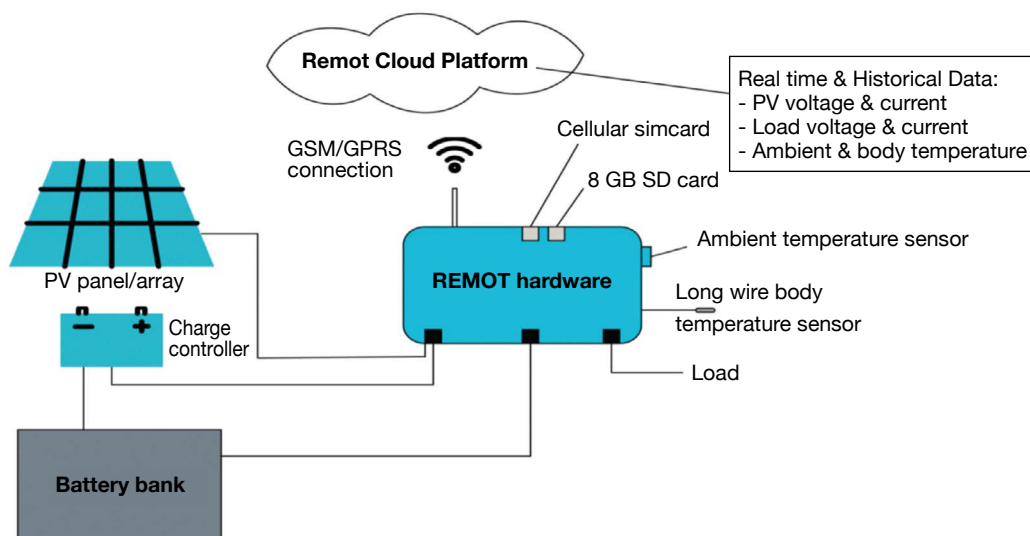

Figure 4.20

Example of solar powered data logging system with SD card storage combined with mobile data connection to a cloud platform (Source: Innovex, <https://innovex.org/remot>).

Remote monitoring is increasingly offered as part of a cold room leasing, purchase or as a subcontracted service. Considerations for remote monitoring include:

- Focus also on what system status and performance information is necessary for local users to see easily. Sophisticated remote systems have been seen that had no local readout at all without a laptop – to which local users, of course, did not have access. All commercial data monitoring systems have phone apps (see example in Figure 4.21) but users on site should in any case be able to easily see the temperature and humidity in the cold room as an absolute minimum.
- Consider whether local users and/or those monitoring remotely should have control over system settings (and which settings).
- Subscription costs for remote monitoring.
- Have a contingency plan if the GSM network fails intermittently or completely.
- Consider using remote monitoring to help plan for maintenance.
- For higher level of business management, a third-party remote monitoring hardware/software system may be worth considering that includes market analytics and a crop management platform (see example in Figure 4.21). Such apps monitor the overall system performance in a cloud-based management platform. Its database can monitor the status of thermal or battery backup as well as compressor operation with algorithms to trigger use of stored energy if the storage temperature rises, for example if warm produce is loaded or the door is open for long. The systems can also record power generated by solar panels to evaluate overall system performance.

The Efficiency for Access guides mentioned above provide extensive information on sensors of many types, their specifications, sources and indicative price ranges.

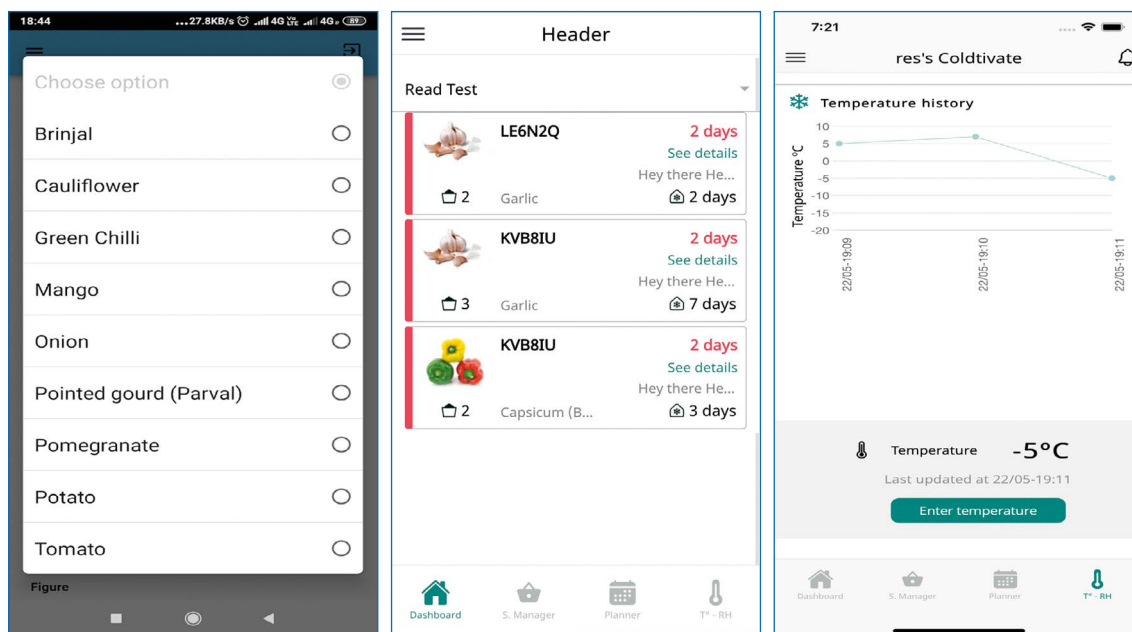

Figure 4.21

Example screen shots from smartphone apps for monitoring a cold room and managing the produce (*CoolCrop*, *VCCA Coldtivate*).

4.11 Considerations for siting of equipment (cold room layout)

4.11.1 Layout for ease of loading: access paths, racking and lighting

Include use of containers (cartons or crates) and produce packaging and stacking as part of the design plan from the outset:

Pallets of stacked containers are ideal for storage of a single type of produce that has been pre-cooled elsewhere, if space and access enable use of palletised loads. But a WICR that is used for mixed loads of different types and sizes of containers should have racks or deep shelves to allow easy access and good airflow around the produce.

Design of racking:

Specify racking for the intended usage pattern but that is also flexible for optimisation and to allow for seasonal changes in produce and future business development.

Racking should be constructed from a rust proof metal that has the strength to support the maximum likely stored product and be secured so it cannot fall over.

Provide racking with deep shelves with plenty of separation that will not only accommodate the planned types of boxes or containers but also allow good airflow between boxes and through the shelves or racks (see Subsection 2.3.7). Achieving high capacity for storage by densely packing the boxes and shelves is pointless if it results in poor airflow: the produce will simply not get cooled adequately and will spoil much more quickly than necessary.

Ensure that racking is installed to leave a gap between racks and walls, also for airflow reasons.

Consider using shelves or racks with a lip at rear to prevent boxes being pressed against the wall – the airflow gap must be maintained near walls.

Cold room layout for ease of access:

In terms of layout, think through how users will carry produce into the store, all the way from the holding area where it is delivered through to the storage shelf. Consider if this will be entirely manual or involve wheeled handling equipment – in either case, design for smooth transitions, no trip hazards and ramps preferred rather than steps.

Consider how wide the containers are, allowing space for the hands/arms of staff, and other equipment to carry the containers. Then ensure doorways and aisles between racking are plenty wide enough for comfortable access and to fully turn round in suitable places. Check that door handles, temperature sensors, evaporators and other features will not get in the way or get damaged by access movement. Insulation panels and doors should be protected from bumps and especially puncture caused by movement of containers or lifting equipment – fit protective metal sheets over parts of panels likely to be struck; fix bumpers to the floor that deflect trolleys before the wall is hit.

Consider layout of racking that enables containers first loaded to be retrieved without unloading later ones. Some level of inspection of produce should be possible in a fully loaded cold room without having to rearrange (many) containers.

Effective lighting:

Ease of access requires not only space to move but also light to see what is to be done or retrieved. Light fittings should cast into each access path and onto at least the edge of each shelf. White shiny surfaces on walls and partitions make reflected light almost as useful as direct light so maximise that to bounce light into otherwise darker areas. Baffle plates where walls meet the ceiling can help smooth airflow and reflect light down walls if baffles are too white and shiny (but must be either sealed to the wall and ceiling or accessible to clean behind).

For guidance on operational issues on access and loading, see Section 7.7.

4.11.2 Design for good airflow (circulation of air)

It is important to design a cold room layout that allows air from the evaporators to flow under the load, between pallet loads and over the top of the containers in order to maintain the target temperature inside the cold room (see also 2.3.7). Adequate airflow must be maintained during all storage periods. Most cold storage is designed to have an airflow capacity up to 0.05 m³/s/1000 kg of produce, however water loss has to be taken care of, reducing air velocity (see Subsection 2.2.3). Airflow must be distributed uniformly throughout the cold room to minimise temperature variability. Produce must be loaded carefully for smooth airflow around the produce and to prevent air bypassing the produce (i.e. finding a 'short circuit' route blown from the evaporator back to the evaporator intake, avoiding most of the produce). If necessary, open spaces around the produce can be deliberately blocked to force air through the stack of produce. 'Spacers' sometimes referred to as 'egg crates' can be placed between layers of produce to distribute air as evenly as possible and avoid contact with walls.

4.11.3 Placement of evaporators

The placement of the evaporator(s) is an important consideration for good airflow and the efficient operation of the walk-in cold rooms and chillers, as improper placement can lead to wasted energy and performance issues.

The airflow from the evaporator(s) must reach the entire room (or product, see section on blast chilling) to provide a uniform temperature.

- Do not install an evaporator in an area where it will interfere with the aisles or storage racks. This may cause a problem for the cold room owner, which could result in the evaporator needing to be relocated. The location of the evaporator should allow for easy storage and removal of the refrigerated product. Do not install the coil where refrigerated produce could potentially be stacked and block the airflow. Spacer bars in front of the evaporator may be necessary to prevent this.
- Always allow sufficient space between the rear and sides of the evaporator and the wall to permit free return air. A clear space of at least 0.7 m must be allowed above the stacked produce to permit airflow from the coolers to diffuse freely.
- A guide for minimum clearance for proper airflow and service access between an evaporator and walls is equal to or greater than the coil height. Refer to the manufacturer's installation guidelines for minimum spacing requirements.
- Safe access for service and maintenance must be provided, including clear access to all serviceable components such as the electric defrost heater elements within the unit, if fitted.
- The evaporator unit must be installed level on the horizontal plane.

- Never install an evaporator above a door. Placing an evaporator above a door can cause the evaporator to draw warm, humid air through the coil each time the door is opened. This will cause the evaporator to frost up more quickly.
- With multiple-evaporator applications, always trap drain lines individually to prevent vapour migration. With lower temperature applications (< 0°C) drain traps must be located outside the cold room.

When designing mountings for evaporators, do not forget to include the extra weight of fully frosted refrigeration evaporators, which can be a heavy load (Figure 4.22).



Figure 4.22

Frontal view of an evaporator placed inside a large size cold room. Return air enters from the rear, passes through the cooling coil and is rejected by the fans. Positioning the fans after the cooling coil allows the best exploitation of their heat transfer surface.

4.11.4 Placement of thermal energy storage systems in the cold room

Thermal energy storage can be installed in the system or in the cold room. As lighter warm air naturally tends to rise and heavier cold air tends to drop within the cold room thermal energy storage (TES) units are most effective when installed high within the cold room, preferably near or on the ceiling.

TES units should be mounted so that air from the evaporator or fan-coil unit flows over them so that they get charged. Orientate TES units so that air can flow freely past them in the direction it is being blown. When fans are not running, air must be able to circulate across the surfaces of the TES units and the more surfaces that are exposed to air circulation, the faster air in the room can be cooled. So, for fastest cooling, TES units should be mounted on brackets that leave an airflow gap of 3 cm to 4 cm between TES and ceiling and similar gaps between TES units; slower release of cooling (e.g. to cover long periods without the refrigeration plant running) can be achieved by closing the gaps between units and ceiling and between units, so restricting air flow. Bear in mind that slower release of cooling also means slower charging of the TES units.

To pack more TES units into a space, TES units can be packed together in blocks (in contact with one another) but allow air flow space between blocks. Avoid creating closed or 'dead end' void volumes between TES units and walls or ceiling that will hold stagnant air – if air cannot flow through the space, then it is effectively wasted space.

TES units are heavy and whatever they are bolted to must be strong enough to bear the weight. Bolting into insulated panels should be avoided. A slim but load bearing support structure for the TES units that stands on the floor would be ideal. If any bolting is done into panels, professional advice is essential to firstly confirm if the load can be safely borne by the panel(s), to ensure the right specialist fittings are used so that weight is transferred safely to the thin and fragile load bearing skin, the vapour barrier is maintained and thermal bridges minimised.

Figure 4.23 shows TES units mounted on the ceiling of a small cold room with air blown over them by the evaporator. See Section 5.5 for additional detail on thermal energy storage options.

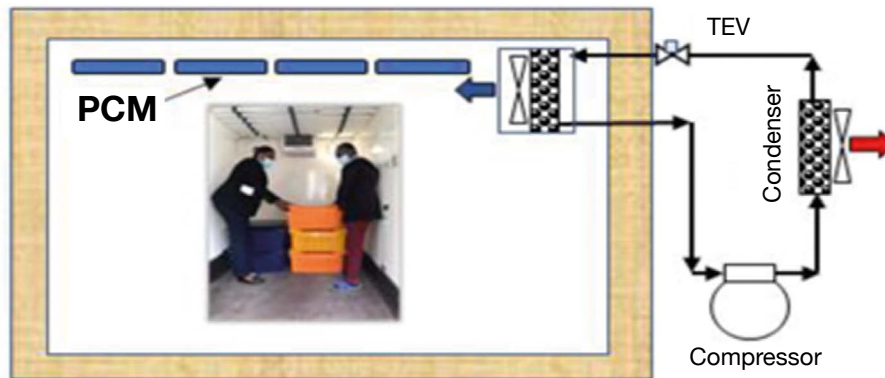

Figure 4.23

Thermal energy storage units mounted cold room on the ceiling of a small cold room (Source: PCM products).

4.11.5 Placement of condensers

Always refer to the manufacturer's installation guidelines for the minimum spacing requirements, but the following should be considered when positioning the unit:

- Select a location to minimise the refrigeration pipe lengths. Longer distances require more refrigerant to pump around the circuit, resulting in greater energy consumption.
- Follow the manufacturer's instructions for clearance between condensing units and walls or other obstructions (at least half a metre).
- If two or more condensing units are close together, make sure they are aligned so that hot exhaust air blows away from other units. If exhaust from one unit blows towards intake of another, then efficiency will be poor.
- Ensure there is adequate free airflow around condensers to allow heat to disperse. Air-cooled units add a lot of heat to the space they occupy.
- A condenser with fan(s) running creates a strong draught of warm air. They are relatively noisy and can cause vibration to the mountings (especially if any fan blades are damaged). Draughts, noise and vibration have nuisance and disruption impacts for people working or living nearby and their welfare should be considered in how and where the condensers are mounted.
- Safe access for service and maintenance must be provided, including clear access to all serviceable components within the condensing unit.

4.11.6 Positioning monitoring equipment and sensors

Considerations for installing monitoring equipment include:

- **Hardiness:** how weatherproof and robust; tolerance of harsh conditions and mistreatment.
- **Security:** how secure or concealed the monitors need to be on site, how to prevent tampering and theft.
- **Location:** optimise equipment location between convenience for WICR users and 'best spot to measure' (e.g. you may want the temperature in the centre of the storage space, but that is where users want to store produce).
- **Avoid compromising WICR structural integrity:** minimise cutting and drilling of insulation, e.g. holes for sensor wires. This could affect the warranty, compromise performance and damage the vapour seal.

- **Wiring:** carefully consider routing of wires to avoid risk of being snagged by crates or staff or machinery and lay neatly and clearly for easier fault-finding. Consider the variety of connectors that may be present in the WICR and how the current and voltage sensors will be connected. A wireless connection may be most suitable but could be costly.

See also Subsection 4.10.4 for monitoring technical parameters and Section 7.8 for monitoring for operational performance.

4.12 Design for safety of staff and cold room

Safety of staff and the cold room must be part of your discussion with suppliers, including fire and suffocation risks. Local regulations must be applied.

4.12.1 General safety of personnel

Legal safety requirements vary by country and by type of facility, also taking account of who has access, so check what legal obligations are in force for the facility. This section combines requirements that are mandatory in many countries (for which the word 'shall' is used) as well as widely recognised good practice (for which the word 'should' is used).

Only authorised people should be allowed to enter the cold room or chiller. Clear, conspicuous signs shall be prominently displayed at the entrance door(s), indicating 'No unauthorised entry'. Such people should be fully instructed on the means of escape, the use of 'locked-door' opening devices and trapped-person alarms. It is essential that all doors at cold rooms shall be installed so that they can be opened from the inside even when locked from the outside. A trapped-person alarm, with battery back-up, shall be provided. The alarm shall sound distinctively and be clearly distinguishable from other alarms (e.g. fire alarm) and the triggering device shall be located in an area where personnel are located.

The exit to the cold room shall be suitably positioned with due regard for the operational layout and shall not be obstructed by racking, stock or equipment. Such exits shall be adequately signposted with either emergency lighting or luminous signs located in such a way that they are not obstructed by racking, stock or equipment.

Trapped-person alarms and door release devices shall be properly maintained and regularly tested to ensure that they are in good working order. The testing shall be recorded.

Other safety issues should be considered and be part of a general risk assessment. These include:

1. Refrigeration burns potential from either cold or hot pipes or components. Mitigate through pipe isolation, good access to components and valves.
2. Systems operating at very high pressures, system vents and safeties, pressure vessels. Mitigate through good signage and ensuring only qualified personnel have access to the plant.
3. Lifting and manual handling strains, working at height. Mitigate through access to ladders, manual handling equipment and training of staff.
4. Rotating equipment such as fans. Mitigate through use of guards, safety protection and minimise access of personnel to relevant equipment.
5. Electrical hazards. Mitigate through ensuring qualified personnel only work on electrical panels, that sufficient clearance is allowed for access to panels, ensure correct IP rating for equipment and limit access to relevant personnel.

6. Trip hazards, especially when staff are carrying produce crates or equipment. Mitigate by care with design of floor levels and where different floor surfaces meet; provide good lighting; ensure wiring does not trail on floors; consider a ramp with non-slip surface in heavily used areas instead of a few steps.
7. Slipping hazards due to oils, water or ice build-up. Mitigate though ensuring staff wear appropriate shoes and personal protective equipment (PPE), and that safety checks are regularly done.
8. Suitable ventilation systems are in place to prevent build-up of dangerous gases. Mitigate through careful ventilation. See also Subsections 4.9.5 and 2.3.5.

4.12.2 Door safety

The door shall be large enough to allow occupants to escape and always be openable from inside without a key.

4.12.3 Suffocation risks (asphyxiation)

Low oxygen levels are a risk inside stores. Personnel breathe in oxygen and breathe out CO₂, plus produce respires and depletes oxygen levels. This means that CO₂ levels could rise and pose a risk to staff. Leakage of refrigerant inside the cold room may also displace oxygen. CO₂ asphyxiation by hypoxia causes unconsciousness extremely rapidly and can result in respiratory arrest in less than a minute so staff may be unable to get out before collapsing. There is significant danger if people inhale CO₂ at concentrations above around 7% in air (i.e. > 70 000 ppm) (Harper, 2011).

The use of CO₂ monitors is advisable but seek advice on the level of risk for the situation. Ensure good ventilation is provided.

4.12.4 Fire risks

The incidence of serious fires in cold rooms is high despite the low temperatures involved. There are various contributory factors such as:

1. The combustible nature of organic foam insulation materials, notwithstanding the 'flame retardant' properties which may be claimed for them.
2. The use of flammable refrigerants as working fluids for the cooling unit. Hydrocarbons are more and more used to face the ozone depletion and greenhouse effects.
3. The presence of readily combustible material such as wooden pallets, particularly when dehydrated by prolonged exposure to low temperatures.
4. The flammability of much commonly stored merchandise including starch, sugar, butter, cheese and meat.
5. The embrittlement at low temperatures and deterioration with age of some electrical insulating material.

NOTE:

Consideration should be given to operating temperature and humidity in specifying and selecting electrical cabling and equipment.

Various fire detection systems for heat and smoke are commercially available and use of these is good practice. All devices used shall have been tested at low temperatures and shown to be satisfactory. Insurance providers may have very specific requirements that must be met in full.

4.12.5 Safety of refrigerants

The risks related to refrigerant use may include working with volatile liquid under pressure, working at low temperatures (below 0°C), working at high temperatures (above 55°C), working at heights, lifting heavy equipment, working with live electrical equipment and working with various chemicals (including refrigerants, lubricants, adhesives, cleaning products and paints). Some refrigerants are toxic, and in industrial systems all of them (except for air used in Brayton cycle equipment) present a risk of asphyxiation. Some refrigerants are flammable and require additional precautions. The risk associated with these hazards is virtually eliminated if the system has been designed and is operated in accordance with international standards and safety codes. See also Section 4.8.

4.13 References

- AIRAH, 2012.** Methods of calculating Total Equivalent Warming Impact (TEWI), Australian Institute of Refrigeration, Air conditioning and Heating, 2012. Available from: https://www.airah.org.au/AIRAH/Navigation/Resources/Best_Practice_Guidelines/BPG.aspx
- ASHRAE, 2019.** ANSI – ASHRAE 34-2019. Designation and. Safety Classification of. Refrigerants.
- GIZ, 2019.** Insulation Materials available in Zambia and suitable for Cooling Insulation in conjunction with standardized Solar Cooling Units in Rural Areas. GIZ, 2019. Available from: https://www.green-cooling-initiative.org/fileadmin/user_upload/Insulation-materials-available-in-Zambia_GIZ_ABCEC_FGCT_2019.pdf
- Harper P., 2011.** Assessment of the major hazard potential of carbon dioxide (CO₂). Health and Safety Executive. Available at <https://www.hse.gov.uk/carboncapture/assets/docs/major-hazard-potential-carbon-dioxide.pdf>
- HIA 2022.** Postharvest management of vegetables- Cool rooms. <https://www.postharvest.net.au/postharvest-fundamentals/cooling-and-storage/cool-rooms>
- IPCC 2021.** IPCC's 6th Assessment Report, Climate change 2021, The Physical Science Basis, Glossary. Available from: <https://www.ipcc.ch/report/ar6/wg1>
- ISO, 2014. ISO 817:2014.** Refrigerants-Designation and safety classification.
- Keller, N., Ducamp, M.N., Robert, D., Keller, V., 2013.** Ethylene removal and fresh product storage: a challenge at the frontiers of chemistry. Toward an approach by photocatalytic oxidation. Chemical Reviews. 113(7), 5029-5070.
- Kitinoja L., Kader A.A., 2015.** Small-scale postharvest handling practices: a manual for horticultural crops, 5th Edn. Davis, CA: Postharvest Technology Research and Information Center, University of California, Davis. https://ucanr.edu/sites/Postharvest_Technology_Center_/files/231952.pdf
- Kitinoja, L., Thompson J.F., 2010.** Precooling systems for small-scale producers Stewart Postharvest Review, vol. 6, N° 2 (01 June 2010) : 1-14, DOI: 10.2212/spr.2010.2.2.
- Parsons R.A. and Kasmire R.F., 1974.** Forced-air unit to rapidly cool small lots of packaged produce. University of California Cooperative Extension, OSA #272.

Thompson JF and Spinoglio M., 1996. Small-scale cold rooms for perishable commodities. University of California, DANR Publication 21449.

Thompson, J., 2001. Energy conservation in cold storage and cooling operations. Perishable Handling Quarterly Issue No 105. Pp 7-9.

UBA, 2021. Persistente Abbauprodukte halogenerter Kälte- und Treibmittel in der Umwelt: Art, Umweltkonzentrationen und Verbleib unter besonderer Berücksichtigung neuer halogenerter Ersatzstoffe mit kleinem Treibhauspotenzial. Umwelt Bundesamt (UBA). (2021). Available from: https://www.umweltbundesamt.de/sites/default/files/medien/5750/publikationen/2021-05-06_texte_36-2021_abbau_kaelte-treibmittel.pdf

4.14 Appendix 1: Detailed estimation of the heat load

4.14.1 Nomenclature

A	surface area (m^2)
c	specific heat ($J\ kg^{-1}\ K^{-1}$)
d	day of year (integer)
e	efficacy of lighting lamps ($lm.W^{-1}$)
E	effectiveness of door protection or blockage
EL	Elevation (radiants)
F	density factor
g	acceleration due to gravity ($9.81\ m.s^{-2}$)
h	convective heat transfer coefficient ($W.m^{-2}.K^{-1}$)
H	height of cold room door (m)
HRA	hour angle (radiants)
k	thermal conductivity ($W.m^{-1}.K^{-1}$)
l	latent heat for water ($J.kg^{-1}$)
L	length of door seals (m)
LF	luminous flux ($lm.m^{-2}$)
LST	local solar time
m	mass flow rate ($kg.s^{-1}$)
M	mass loaded per day ($kg.day^{-1}$)
N	number
P	electrical power (W)
q	heat flow per unit area ($W.m^{-2}$)
Q	heat flow (W)
r	proportion of solar radiation incident on surface (ratio)

t	duration (s)
S	shaft power (W)
T	temperature (°C)
U	overall heat transfer coefficient ($W.m^{-2}K^{-1}$)
v	volume flow rate through seals per metre of seal length ($m^2.s^{-1}$)
V	wind speed ($m.s^{-1}$)
X	concentration of water in dry air (specific humidity) ($kg_{H_2O} kg_{air}^{-1}$)
δ	declination angle (degrees)
Δ	thickness (m)
ρ	density ($kg.m^{-3}$)
μ	efficiency
φ	latitude

Subscripts

ad	air through door
de	defrost
do	door opening
ds	door seals
f	floor
fu	fusion
i	inside
l	lights
me	evaporator fan motor
o	outside
ot	other
pe	personnel
pr	product
r	respiration
s	solar
u	unfrozen
w	wall
wp	water from product/packaging

4.14.2 Total heat load

The total heat load, Q_T (Watt) on the cold room is given by

$$Q_T = Q_w + Q_{do} + Q_{pe} + Q_{pr} + Q_{me} + Q_{de} + Q_l + Q_f + Q_{ot} + Q_r \quad (1)$$

4.14.3 Heat through the insulation (transmission)

The shape of the cold room can generally be assumed to be a rectangular box. The heat load through the cold room walls is calculated using (2). Since this includes the solar gain temperature (T_s), this calculation must be made separately for any surfaces that are in direct sun (see Subsection 4.15.3 Solar gain):

$$Q_w = U \cdot A_w \cdot (T_0 - T_i + T_s) \quad (2)$$

The overall heat transfer coefficient, U is calculated using (3).

$$\frac{1}{U} = \frac{1}{h_i} + \frac{1}{h_o} + \frac{\Delta_w}{k_w} \quad (3)$$

Most chilled cold rooms will have wall panels at least 100 mm thick. Some typical values for thermal conductivity are presented below. Calculation of transmission across cold room walls provides an idealised estimate of the transmission heat load. Panels may be damaged or degrade over time and transmission could increase. Therefore, it is recommended that the integrity of walls is checked on a regular basis by thermographic scanning of the walls. This can highlight areas where the insulation is damaged and should be replaced/repared. Typical values for the thermal conductivity of cold room walls are reported in Table 4.4.

Table 4.4

Typical values for thermal conductivity of cold room walls (*Values mainly from: <https://www.greenspec.co.uk/building-design/insulation-materials-thermal-properties/>*).

Typical values for thermal conductivity k of cold room walls (W.m-1.K):	
Uninsulated suspended concrete	0.177
Straw	0.08
Hempcrete is a mixture of hemp hurds (shives) and lime (possibly including natural hydraulic lime, sand, pozzolans or cement)	0.06
Cellular glass	0.041
Mineral wool	0.040
Modified phenolic	0.040
Hemp	0.039 - 0.040
Icynene H2FoamLite / LD-C-50 (wet spray; poured)	0.039
Cellulose (blown/sprayed) made from recycled newspaper	0.038 - 0.040
Wood fibre	0.038
Wool	0.038
Expanded polystyrene	0.036-0.038
Glass mineral wool	0.035
Rock mineral wool	0.032–0.044
Extruded polystyrene	0.024
Polyurethane (PU)	0.02
Polyisocyanate (PIR)	0.02
Phenolic foam	0.02
Aerogel	0.014
Vacuum insulated panels (VIPs)	0.007

Cold room walls are usually a modular construction, with an insulating inner and thin outer cladding. The outer cladding has a negligible effect on the U value so can be ignored. A surface heat transfer coefficient of typically $9.3 \text{ W.m}^{-2}.\text{K}^{-1}$ can be used for h_i (ASHRAE, 2021). The heat transfer coefficient outside the cold store, h_o , is related to the wind speed outside (unless the outside wall adjoined another building, in which case it was set to be h_i), using the simplified equation for forced air of less than 5 m.s^{-1} at room temperature (4) (McAdams, 1954).

$$h_o = 5.62 + 3.9 \cdot V \quad (4)$$

It should be noted that for cold rooms placed directly on the ground floor heating may be necessary where temperature of the cold room is below 0°C as water in the ground below the room may eventually freeze and cause 'frost heave' (cracking and raising of the cold room floor). Cold rooms which are placed above ground with airflow underneath the cold room may not require underfloor heating. Depending on the type of heating system used the heat load can either be estimated from the cold room designers' data or real measurements.

4.14.4 Solar gain (radiation)

External cold rooms experience considerable fluctuation in temperature of the external cold room surface. This can cause stress in panels and eventual panel breakdown in extreme cases. White cladding is generally considered to be best as it has low emissivity and reflects radiant heat. The influence of radiant heat can be considered in the transmission heat load by increasing the outside air temperature (ASHRAE, 2021). Figures from ASHRAE are shown in Table 4.5 where the figures are applied over a 24-hour period when calculating wall heat gain. When using the figures in Table 4.5, it should be remembered that these are designed for 'average' conditions and so values of U for high solar radiation countries will be higher.

Table 4.5

Increase in surface temperature due to solar radiation for solar activity typical in the USA (ASHRAE, 2021).

Surface types	Typical rise in temperature due to solar gain for wall facing in compass direction and flat roof ($^\circ\text{C}$)			
	East	South	West	Flat
Dark coloured: Slate roof Tar roof Black paint	5	3	5	11
Medium coloured: Unpainted wood Brick Red tile Dark cement Red, grey or green paint	4	3	4	9
Light coloured: White stone Light coloured cement White paint	3	2	3	5

The solar temperature T_s is an adjustment to compensate for solar effect on heat load and is described in (5).

$$T_s = \frac{q_s \cdot r}{h_o} \quad (5)$$

Where q_s is the solar radiation on the surface and r the proportion of solar energy transmitted on each surface. h_o is the heat transfer coefficient outside the cold room (related to the wind speed outside, unless the outside wall adjoins another building, in which case it was set to be h_i).

Average hourly statistics for direct normal solar radiation can be found from weather data files.

Radiation is not evenly distributed over the surfaces (walls and roof) of the cold store, instead the distribution of solar radiation changes throughout the day as the sun rises and sets in the sky. To approximate the proportion of solar energy, r , transmitted on each surface (east, west, south and north roof) the following equation is used:

$$r_x = \frac{I_x}{I_w + I_e + I_s + I_n + I_r} \quad (6)$$

Where $x = w, e, s, n$ or r for each of the west, east, south and north walls and the roof.

For each wall, the ratio of solar radiation incident at an angle to the sun to that normal to the sun, I , is calculated from:

$$I_e = -\sin(\text{HRA}) \quad (7)$$

$$I_w = \sin(\text{HRA}) \quad (8)$$

$$I_n = 0 \quad (9)$$

$$I_s = \sin(90 - \text{EL}) \quad (10)$$

$$I_r = \sin(\text{EL}) \quad (11)$$

A simplistic approach to estimating the amount of solar radiation on each of the cold room walls can be used to consider the sun's position in the sky relative to the East-West axis and South-North axis. For the sun travelling from East to West according to the hour angle HRA as shown in (12).

$$\text{HRA} = 15 \cdot (\text{LST} - 12) \quad (12)$$

The angle in the sky on the South-North axis is equal to the solar elevation angle, EL. This is the angle between the horizon and the centre of the sun's disc (13). If elevation ≤ 0 then solar radiation = 0 (night time).

$$\text{EL} = \sin^{-1}[\sin \delta \sin \phi + \cos \delta \cos \phi \cos(\text{HRA})] \quad (13)$$

ϕ is the latitude.

The declination angle, δ is calculated in (14), where 23.45 is the angle of tilt of the Earth's axis.

$$\delta = 23.45 \cdot \sin\left[\frac{360}{365}(d - 81)\right] \quad (14)$$

4.14.5 Heat from air infiltration

Assuming that a cold room has only one door and the room is otherwise fully sealed, a supposition can be made that the cold room has sufficient thermal mass so that door openings do not change the temperature within the cold store. This may not be fully correct for a small cold room and will overestimate the heat load.

For small cold rooms with longer doors openings (more than 10 seconds) it is possible to write a simple Excel-type model where the heat loads are iterated across time steps to generate a more accurate assessment of heat load from infiltration.

The heat load through the door opening (the door itself and the door seal), Q_{do} , is calculated using the sensible and latent heat exchange caused by mass flow of air during door opening and through the seals when the door is closed (15). The additional sensible heat of water vapour is ignored, as the specific moisture content is generally less than 1%. The latent heat of fusion $l_{fu} = 0$ when the evaporating temperature $> 0^{\circ}\text{C}$.

$$Q_{do} = (m_{do} + m_{ds}) \cdot \left[c(T_o - T_i) + (X_o - X_i) \cdot (l_{fu} + l_v) \right] \cdot t_{do} \cdot \frac{N_{do}}{(24 \cdot 3600)} \quad (15)$$

The mass flow through an open door is calculated using the Gosney and Olama model (1975) (16). An effectiveness value is used to reduce the infiltration for door protection devices and traffic obstructing the opening as detailed by Chen et al (2002).

$$m_{do} = (1 - E) \cdot 0.221 \cdot A_d \rho_i \left(1 - \frac{\rho_o}{\rho_i} \right)^{0.5} (g \cdot H)^{0.5} \cdot F \quad (16)$$

The density factor is calculated according to

$$F = \left(\frac{2}{1 + \left(\frac{\rho_i}{\rho_o} \right)^{0.333}} \right)^{1.5} \quad (17)$$

The mass flow through the door seal is calculated using (18). Default values for volume flow rate through seals, v of 0.003 and 0.0006 $\text{m}^3 \cdot \text{s}^{-1}$ per metre of seal length can be applied for bad and good seal respectively. These values were the extreme values presented by Cleland (2011).

$$m_{ds} = v \cdot \rho \cdot L \quad (18)$$

In reality the cold room is unlikely to be completely sealed and air may be added though pressure relief mechanisms or mechanical ventilation or for safety. The heat load from any added ventilation (air change load) should be added to the infiltration load and can be calculated from the average mass (kg/s) of air added to the room multiplied by the enthalpy to cool the air from ambient to cold room conditions.

4.14.6 Heat load from staff working in the store

A person in a cold room emits around 270 W of heat, and this can be added up for the number of people and duration of their time inside the cold room. The heat load (per person in W) for the period in which the person is in the cold room can be calculated using the following equation (ASHRAE, 2022).

$$Q_{pe} = 272 - (6 \cdot T_i) \quad (19)$$

The total load (in Wh) can be calculated at this heating rate (W) based on how long one or more people are in the cold room (hours). When people first enter the cold room, they bring in additional surface heat. Thus, when many people enter and leave every few minutes, the load is greater than that in (19). If personnel enter and leave frequently, the values calculated in Equation (19) should be multiplied by 1.25 (ASHRAE, 2022).

4.14.7 Product load including precooling

The product load is calculated from the mass of product entering the precooling zone, or store, every 24 hours (M_{pr}) and the temperature difference between the product when it entered the cold room (T_{pr}) and the temperature of the cold room (T_r). Generally, the best case is that the product is at the ambient temperature if harvested above ground or at the average daily temperature if dug from shallow ground, but any produce exposed to the sun could be at significantly higher temperatures than that. A simple hand-held thermometer can quickly determine actual input temperatures and so warn of possible system overload. To derive the figure as a daily heat load, it is generally assumed that all heat is removed from the product in 24 hours and that there is no latent heat from the product (freezing/thawing). Specific heat capacity values for many types of produce are available from online engineering resources such as Engineering Toolbox¹². Values calculated using the COSTHERM program (Miles et al, 1983) are shown in 4.6. The specific heat c_p is the heat energy (J) extracted from 1 kg of the produce to reduce its temperature by one degree Kelvin (equal to one degree Celsius).

$$Q_{pr} = \frac{M_{pr} \cdot c (T_{pr} - T_r) + (M_{wp} \cdot l)}{24 \cdot 3600} \quad (20)$$

If the specific heat for a particular food is not available, the following may be used to calculate specific heat based on known values of its components (note: only valid above freezing point):

$$c_u = \sum c_i x_i \quad (21)$$

Where:

c_u = specific heat of an unfrozen food (kJ/kg)

c_i = specific heat of the individual food components

x_i = mass fraction of the food components

or:

$$c_u = 4.19 - 2.30x_s - 0.628x_s^3 \quad (22)$$

Where:

c_u = specific heat of an unfrozen food (kJ/kg)

x_s = mass fraction of the solids in the food (where the balance is assumed to be water, for which specific heat capacity is 4.19)

¹²https://www.engineeringtoolbox.com/specific-heat-capacity-food-d_295.html

Table 4.6

Values of the specific heat capacity and constants a and b that are used to estimate the heat of respiration for fruit and vegetable produce at chilled temperatures.

Food name	Specific heat capacity of the produce (above zero), Cp (J/kg.K)	Constants a and b for calculating the heat from respiration in mW/kg (see Eq. 23 in Section 4.14.8)	
		a	b
Apple	3736	15.148	0.097
Apricot	3804	13.813	0.093
Asparagus	4000	88.670	0.113
Avocado*	3010		
Banana	3335	19.092	0.076
Beetroot	3823	17.029	0.073
Blackberry	3672	49.318	0.103
Broccoli	3892	53.273	0.140
Butter	2213		
Cabbage	3923	25.479	0.096
Carrot	3940	9.161	0.139
Cauliflower	3995	25.395	0.145
Cherry	3653	14.484	0.097
Chicory	4094		
Eggplant / aubergine*	3940		
Endive	4022		
French bean	4071		
Gooseberry	3908	22.110	0.073
Grape-black	3627	8.636	0.114
Grapefruit	3928	11.683	0.075
Greengage	3556		
Guava*	3600		
Ice cream	3203		
Leek	3795	28.991	0.150
Lemon	3767	16.639	0.066
Mango*	3740		
Milk	3874		
Milk-skimmed	3948		
Milk-UHT	3874		
Mushroom	3966	96.145	0.102
Nectarine	3616		
Onion	3990	7.926	0.095
Orange	3792	10.109	0.100
Parsley	3594	119.276	0.087
Peach	3793	13.419	0.136
Pear	3702	14.160	0.120
Peas	3595	92.372	0.107
Pineapple	3735	3.929	0.147
Plum	3732	8.509	0.111

Food name	Specific heat capacity of the produce (above zero), C_p (J/kg.K)	Constants a and b for calculating the heat from respiration (mW/kg) (see Section 4.15.8)	
		a	b
Pomegranate*	3560		
Potato	3485	24.966	0.066
Radish	4007	14.632	0.113
Raspberry	3705	49.381	0.094
Rhubarb	4027		
Spinach	3779	45.885	0.156
Strawberry	3875	44.900	0.114
Sweetcorn	3204	132.818	0.091
Tomato	4009	12.279	0.106
White bread	2423		
Whole eggs	3594		
Wholemeal bread	2460		
Yam*	3270		
Yogurt-natural	3812		

*Sourced from https://www.engineeringtoolbox.com/specific-heat-capacity-food-d_295.html and other sources.

4.14.8 Heat from respiration

Heat of respiration, Q_r , is predicted in mW/kg using Eq. (23) and the parameters from Table 4.6.

$$Q_r = m a e^{T_i b} \quad (23)$$

Where m is the mass of produce, a and b are respiration coefficients derived from line fits using data from ASHRAE (2022), shown in Table 4.6. T_i ($^{\circ}\text{C}$) is the temperature inside the room and e is the exponential number (value is approximately 2.718).

4.14.9 Heat from fans

The heat load of the evaporator fan motors, Q_{me} , is calculated using equation (24). It is assumed that the electric motor is mounted outside of the cold store, $\mu_{me} = 1$.

$$Q_{me} = \frac{N_{me} \cdot S}{\mu_{me}} \quad (24)$$

4.14.10 Heat from defrost

The heat load from defrosting evaporators is equal to the amount of heat required to melt all the frozen water entering the room through the doorway and from product/packaging divided by the efficiency of defrost minus the heat of water leaving through the condensate drain as in the following equation.

$$Q_{de} = \left(\frac{1}{\mu_{de}} - 1 \right) \cdot \left(\frac{m_{ad} \cdot (X_o - X_i) \cdot l \cdot t \cdot N_{do,24} + (M_{wp} \cdot l)}{24 \cdot 3600} \right) \quad (25)$$

The efficiency of defrost, Q_{de} , is defined as the energy required to melt the ice divided by the energy input by the defrost. Therefore, if the efficiency of defrost was 0.5, twice as much energy as needed would be used to melt the ice.

4.14.11 Heat from lights

Lighting has a direct effect (through the electrical energy used to power the lights) and an indirect effect through the heat generated from the lights that is a heat load on the cold store. The heat load from lighting is generally calculated as being equal to the power of the lights multiplied by a time factor related to usage of the lights. The power used by each light is simply obtained from the light fitting or manufacturers data.

Heat load from the lights is calculated from the luminous flux distributed evenly over the floor and walls divided by the efficacy of the lamps. The time the lights are on is averaged over 24 hours.

$$Q_l = \frac{P_l \cdot t_l}{24} \quad (26)$$

Where:

$$P_l = \frac{LF(A_f + A_w)}{e_l} \quad (27)$$

4.14.12 Heat from other electrical loads

Heat loads for other electrical loads are equal to the electrical loads.

$$Q_{ot} = E_{ot} \quad (28)$$

4.14.13 Heat from other machinery used in the store

Heat loads created by any other machinery and equipment that is operated inside the cold room can be obtained from manufacturers' data, taking the power input (kW) and generally assuming that all of the power ends up as heat in the store, unless it is clear that a known part of the power escapes the cold room in another form.

4.15 References for the Appendix

AIRAH, 2012. Methods of calculating Total Equivalent Warming Impact (TEWI), Australian Institute of Refrigeration, Air conditioning and Heating, 2012.

Available from: https://www.airah.org.au/AIRAH/Navigation/Resources/Best_Practice_Guidelines/BPG.aspx.

ASHRAE. 2021. ASHRAE Handbook, Fundamentals.

ASHRAE. 2022. ASHRAE Handbook, Refrigeration.

Cleland, D.J. 2011. The effect of water vapour on food refrigeration Systems. Proc. Inst. R. 2011-12. 5-1.

Gosney W.B., Olama H.A.L. 1975. Heat and enthalpy gains through cold room doorways. Proc. Inst. of Refrig. 72, p.31-41.

McAdams, W.H. 1954. Heat Transmission. 3rd ed. New York: McGraw Hill.

Miles, C.A., Van Beek, G., Veerkamp, C.H. 1983. Calculation of thermophysical properties of foods. In: Physical Properties of Foods. Jowitt, R., et al. (eds). London: Elsevier Applied Science Publishers. P.103-122.

5.

Energy supply and storage systems

5.

Energy supply and storage systems

5.1 Introduction to Part 5

Part 5 covers the main issues related to power supply and energy management, i.e. the use of energy storage to guarantee some autonomy to the system. It gives instructions for an informed choice of the most profitable configuration. Flow charts to define the most effective solution for the various kinds of energy supply are given (Section 5.2), introducing a detailed description of the components in the energy supply system. Types of photovoltaic systems are described (Subsection 5.3.1), as well as their main components, i.e. PV modules (Subsection 5.4.1) and their mounting structures (Subsection 5.4.2). Energy storage is considered both as electrical and thermal. Batteries and their chargers (Subsection 5.4.3) and inverters (Subsection 5.4.4) are described for the former, thermal storage options (Section 5.5) for the latter. The two kinds of energy storage are then compared in terms of design of their components.

5.2 Options for energy supply and energy management

5.2.1 Four types of electricity supply and their quality

The four electricity access and supply cases for electrically driven vapour compression systems are:

5.2.1.1 Reliable grid

Reliable grid means few outages significant outages would be warned in advance (though not all); reasonable voltage stability. A reliable grid connection will generally meet the international quality benchmarks for public supply such as IEC TS 62749¹ or EN 50160², or achieves reasonably close to that quality. Example criteria from EN 50160 include frequency variation of no more than $\pm 1\%$ for 99.5% of the week; voltage magnitude variations of less than $\pm 10\%$ for 95% of the week; 'majority of supply voltage dips' of less than 1 second and $< 60\%$ of nominal voltage; 70% of 'short interruptions' (< 3 minutes) to be < 1 second long; no more than 10 to 50 'long interruptions' (> 3 minutes) per year; and other criteria. Common metrics for availability and reliability of supplies are SAIFI³ and SAIDI⁴. The quality and reliability of mini-grid electricity supplies is often very good and indistinguishable from a good conventional public grid connection (though for mini-grids some maximum current or other limitations may apply, including planned non-availability

¹ IEC TS 62749:2020 Assessment of power quality – Characteristics of electricity supplied by public networks. This standard sets out expected characteristics of electricity at the supply terminals of public networks for low, medium and high voltage at 50 Hz or 60 Hz.

² EN 50160:2011/A2:2019 Voltage characteristics of electricity supplied by public electricity networks. This standard describes the value ranges within which the voltage characteristics can be expected to remain at any supply terminal in public European electricity networks.

³ SAIFI stands for System average interruption frequency index, which is the average frequency of sustained interruptions per customer over a predefined area, usually over a year. SAIFI is typically between 1.2 and 1.5 for global North economies. Also used are: 'planned SAIFI' and 'un-planned SAIFI'.

⁴ SAIDI stands for System average interruption duration index, which represents the customer minutes/hours of interruption or the average time that customers' supplies are interrupted, usually over a year. SAIDI presents the unavailability in units of time and is typically between 1 and 2 for global North economies. Also used are: 'planned SAIDI' and 'unplanned SAIDI'.

for a few hours per day, in which case it would be classed as a 'limited supply' under definitions in this guide, see below). NREL has published a quality assurance framework for mini-grids⁵ that defines three 'levels of service' (basic, standard and high) in which thresholds are set for key aspects of supply quality – this could provide a basis for negotiating supply quality for a mini-grid connection. This guide enables the reader to specify their power requirements to be agreed with a grid or mini-grid provider.

5.2.1.2 Limited supply

Limited supply means electrical supply of reasonable or good quality but operating less than 24 hours per day – perhaps 4 to 22 hours per day, virtually every day. Availability is usually known in advance so that cold room operation can be sustained during the known outages. Examples of limited supplies include solar arrays, dedicated generator (which could be diesel, although that is non-preferred; see 5.1.2.2), renewable source such as wind, or a mini-grid operating for limited hours per day. In all of these cases battery or other backup measures can be part of the business and operational plan. This guide advises how to plan a system that can cope with a limited supply.

5.2.1.3 Unreliable grid

Unreliable grid means that a connection to an electrical grid is available but power is subject to highly variable quality and reliability, often without prior notice of problems, which prevents reliable operation of the cold room. Some form of backup power is therefore essential. An unreliable grid supply is often experienced in rural locations at the end of long distribution lines, or where many informal or illegal connections have been made that overload transformers, or where voltage and power management equipment is not present or damaged (Figure 5.1). Alternatively, it can result from natural events such as windstorm, flooding, landslides, wildfire, or be found in conflict zones. Availability of supply is a combination of frequency of disruption and duration of disruption for which interruptions can be transient (short), lasting fractions of a second to seconds, or 'longer term' or blackouts, which generally means 5 minutes or more but can be hours or days⁶. 'Transients' cause tripping of protection devices, loss of information, malfunction of computers and stoppage of sensitive equipment⁷. Blackouts will stop all powered equipment unless battery or other backup is available. The most common symptom in unreliable grid situations is long-term voltage sag, under which supplies may regularly or even permanently be running at 20%, 30% or even 50% below nominal voltage. Grids lacking adequate controls can transmit voltage sags and spikes as well as other anomalies caused by equipment such as arc welders and the start-up of large motors connected to the same transformer. Since it is extremely challenging to run a conventional cold room business under these circumstances, an unreliable grid connection is considered as *off-grid* for the purposes of this guide.

⁵ *Quality Assurance Framework for Mini-Grids*. NREL, Ian Baring-Gould, Kari Burman, Mohit Singh, and Sean Esterly (NREL); Rose Mutiso and Caroline McGregor (US DOE). National Renewable Energy Laboratory (NREL); US DOE; Global LEAP, 2016. Available from: <https://www.nrel.gov/docs/fy17osti/67374.pdf>

⁶ IEEE has published a guide on this topic: *1366-2012 IEEE Guide for Electric Power Distribution Reliability Indices*. Available from: <https://ieeexplore.ieee.org/document/6209381>

⁷ See IEC TR 63222-100 *Impact of power quality issues on electric equipment and power systems, due for publication late 2023*.



Figure 5.1

Unreliable grids can be overloaded and unsafe with multiple unauthorised connections leading to wide voltage swings, equipment damage and unpredictable electricity outages (*Tait*).

5.2.1.4 Off-grid supply

Off-grid supply means that no electricity grid connection is available at the site and that a standalone generation system is therefore required. Note that the high quality and availability achieved by most mini-grid systems in otherwise 'off-grid' locations can be indistinguishable from a reliable grid connection, though sometimes with certain restrictions – see the reliable grid section above. This guide provides extensive guidance on how to achieve reliable power from renewable solar photovoltaic power sources in off-grid situations.

When possible, it is recommended to locate the cold room where it can have access to a reliable grid electricity supply (i.e. 22 hours per day with rare disruptions) or a limited supply (i.e. supply is regular, scheduled for less than 22 hours per day). This should be considered even if it means locating the cold room a few kilometres away from an otherwise ideal location from a logistical point of view.

5.2.2 Benefits of energy storage

Since any of the four supply cases can experience electricity supply outages, the guide focuses on providing reliable electricity coupled with energy storage and/or a backup energy source to overcome challenging electricity supply situations.

Energy storage components are typically used to:

- overcome unexpected grid electric supply outages;
- shift grid electricity consumption to off peak and lower rate times of day; or
- bridge the gaps between electricity availability (e.g. planned interruptions, nighttime and cloudy conditions when reliant on solar electricity generation).

Energy storage to bridge these gaps can include thermal energy storage (TES), electric storage batteries, or a hybrid solution with both. The length of an outage or gap will define the time the energy storage is needed, also known as 'autonomy'. For this guide autonomy is defined as the amount of time that a system (with or without energy storage) can sustain acceptable food storage temperature with no additional electricity input. In grid-powered cold rooms autonomy time will equal the predicted length of time the electricity supply is unavailable. For a limited grid autonomy is equal to the hours when the supply is turned off (e.g. 24 hours/day – supply hours/day).

5.2.3 Electrical loads

This guide defines electricity consuming devices as electrical 'loads', referring to the electrical power needed to run them. In a cold room there will be mechanical devices (e.g. compressor, fan), electronic devices (e.g. remote temperature monitoring, local alarms), electrical devices (e.g. defrost, lights, communications) and energy storage devices (e.g. pump, battery charger). See also Section 4.7.

The need for each electrical load will be essential to understand in order to select the most appropriate energy system. For example, a cold room compressor must operate regularly to sustain acceptable storage temperatures and the compressor would then be considered a critical load. While cell phone recharging is important, its timing is flexible and usually considered non-critical.

Similarly, certain food products may be considered critical while other products may be considered less critical. Therefore, the type of product(s) can impact the energy requirements of a cold room as shown in Part 2.

At a minimum, the electricity supply system must meet the electrical energy and power requirements of all critical loads. A cold room power system that is undersized, whether through inadequate estimation of load or to cut upfront costs, risks total loss of power during use and loss of stored produce.

Heat load assessment is described in Section 4.4 and calculation is detailed in Section 4.14, leading to a cooling capacity and then electrical load in kWh/day electrical energy use (and kW peak power requirements). This result is based on the component load electrical requirements and time(s) in use to define the minimum electric supply system. Good practice is to include a reasoned oversize factor for unplanned occurrences and equipment efficiency losses.

The electrical needs estimation must carefully identify all loads that will be connected to the electric supply, or the supply system could be undersized, resulting in a failed system and spoiled products. For example, when solar electricity systems are used, they are sized for a specific, defined power supply. The solar array is therefore limited in generating capacity. If a battery is included, it is also limited in capacity. If additional, unplanned loads are connected then the solar power system capacity may be inadequate leading to cooling system disconnection, damaged product, and potentially premature battery failure.

Component loads are listed including the time(s) of use that are typically estimated by the equipment supplier. Time of use may vary throughout the day, week or seasonally. Cold rooms that are intermittently used may find a market for self-generated excess electricity (e.g. off-season solar power used for ice making). Multiple intermittent uses will require multiple electrical load estimations.

It is essential that the loads are specified by the cooling equipment designer/supplier. Component load electrical requirements are typically obtained from manufacturer specifications for each load. The total electrical load is then estimated as detailed in 4.7.

Once the electrical load specifications are known, the electricity supply must be able to match the load needs. A key consideration for off-grid and hybrid systems is the surge current that occurs when most types of conventional electric motors are started. Starting surge depends on the type of motor, with demand of up to 7 times the motor power rating for a fraction of a second until the motor is spinning. Whilst grid and generator sets manage this fine, inverters and power electronic systems are often current limit protected and will drop connection. It is important, therefore, to request efficient motors with low starting surge (e.g. variable speed motors) to reduce the electricity supply system costs and specify the circuits and components such

as circuit breakers that cope safely with the required surge, without tripping. A PV power system could provide the power supply with a solar array recharging a battery, which could supply the starting surge. The PV alone, without batteries, could not provide the starting surge demand if not adequately sized (Solar Direct Drive, in Subsection 5.3.3.1).

PV or batteries can be coupled to an inverter with 12 to 48 V DC input and 230 V AC, 50 Hz output and adequate power ratings. Nonetheless, the PV power system with batteries could directly provide electricity to DC compressors, reducing the loss due to the inverter.

5.2.4 Electricity supply selection

This section will describe how to compare and select the most appropriate electricity supply source and incorporate energy storage and/or backup systems. For several decades, the World Health Organisation has used a flow chart to guide the selection of the most appropriate energy source for vaccine refrigeration (WHO/UNICEF, 2015). The choices include grid (mains or generator), solar, as well as passive and absorption solutions for the refrigerator. This guide includes selection flowcharts based on a similar approach customised for cold room applications.

Vaccines require very specific and stable storage temperatures. It is not recommended to store vaccines in the cold rooms described in this guide. Consult the WHO PQS Devices Catalogue⁸ for prequalified suppliers of WHO compliant vaccine cold and freezer rooms.

The electricity supply selection process will generally follow one or both of the flowcharts presented below. Figure 5.2 suggests a series of steps to consider enroute to selecting the electricity supply solution when grid electricity is available. Figure 5.3 suggests a series of steps to consider solar supply.

As a starting point, it is recommended that designers consider both grid and off-grid options to select the most appropriate and reliable source. For example, solar electricity can be the most cost-effective solution even where grid electricity is available when grid connection costs are unaffordable, or when the grid is unreliable or when the tariff is excessive.

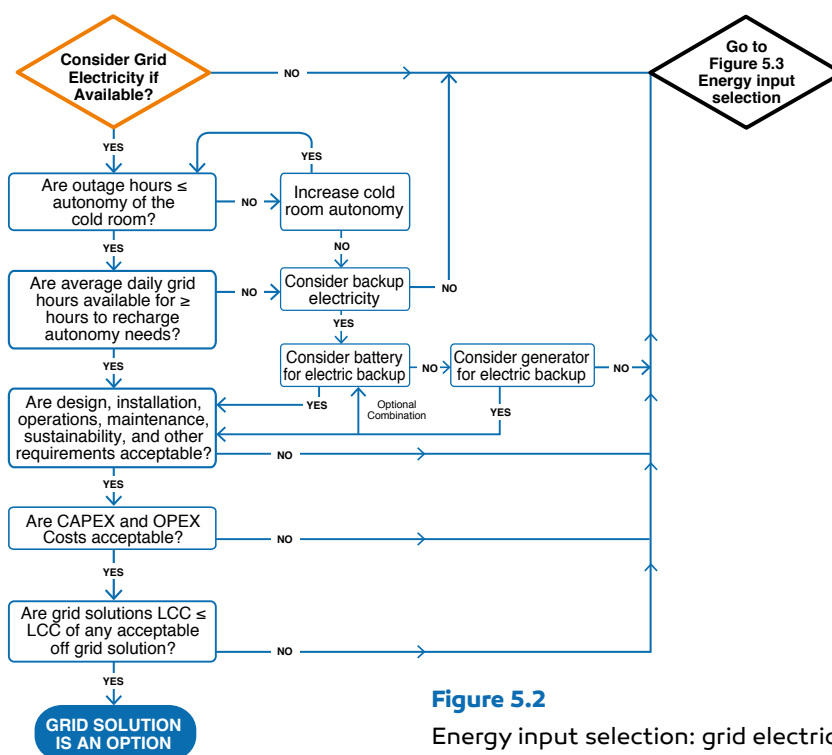

Figure 5.2 Energy input selection: grid electricity solution.

⁸ https://apps.who.int/immunization_standards/vaccine_quality/pqs_catalogue/categorylist.aspx?cat_type=device



5.2.4.1 Reviewing grid electricity as an option

When a regular and reliable supply of electricity can be provided to the cold room, this solution will often be the most cost effective. However, grid electricity supply ranges from extremely reliable, stable and with few outages to unreliable, unstable with numerous outages. Any electricity supply can suffer unexpected outages and an important design decision will be based on the need for sustained cold storage. When a store is to be used for a valuable and temperature-sensitive product, this may justify investment in an energy backup or energy storage with a long autonomy time; whereas storage of less sensitive or less valuable products is likely to mean that a shorter autonomy time is accepted.

If grid electricity is available with the same electrical requirements of the cold room (i.e. voltage, frequency and power capacity), the energy source selection process will next consider factors including grid outages, hours of available grid electricity, quality of grid electricity, operations and maintenance requirements, cost of grid electricity interconnection (e.g. installation cost for new distribution), electricity rate structure (e.g. time of day rates that penalise consumption during peak hours), energy cost and other miscellaneous factors.

Each of these factors will be summarised and key questions noted. If the answer to all key questions is 'yes', then grid electricity is a possible solution. As a next step, it is recommended to compare the grid solution to at least one alternative renewable energy supply solution (see Subsection 5.2.1.4), and if it is found to be a possible solution, then compare advantages and disadvantages of both grid electricity and an off-grid renewable energy solution.

NOTE:

This guide will not focus on renewable energy solutions that are interconnected to an existing grid and synchronised with that grid to enable both import from and export to that grid. This may be an attractive solution in some cases but is beyond the scope of the guide.

The most important considerations to reach a 'go/no-go' decision for the electricity source for grid solutions are below.

Autonomy is the amount of time that a system (with or without energy storage) can sustain acceptable food storage temperature with no additional electricity input. Outage is whenever electricity supply is unavailable. The frequency of outages and the duration of the outage must be included in the design solution in order to establish the design target for autonomy. Seasonal outages can last days (e.g. storm damage to power distribution equipment). If an outage is likely when temperature sensitive products need cold storage, then the cold room must be designed to maintain the acceptable temperature range throughout the outage period. Outages can be difficult to predict and can occur without warning, making this variable challenging to confidently prepare for. The designer may need to estimate the duration of outages without accurate evidence. For all grids (i.e. reliable, limited and unreliable), the outage time must be considered.

Availability is defined as the daily average hours that electricity is reliably supplied. A high availability supply is nearly continuous (e.g. at least 22 hours/average day). Some locations with a limited grid supply may receive a scheduled supply of electricity such as a village with 6 hours of electricity available from 4 to 10 PM. While this supply may be reliable, it will be considered in this guide as a limited supply and low availability. The available supply must be sufficient to maintain acceptable storage temperatures and recharge energy storage sufficiently to meet autonomy requirements.

Design, installation, operations, maintenance, sustainability and other considerations

will include all facets of generating, supplying and sustaining quality electricity. The energy source for generating grid electricity ranges from environmentally destructive fossil fuels to cleaner renewable energy sources and customers often have limited to no impact on the energy source used to generate grid electricity.

Most grid infrastructure must be maintained by trained electrical professionals and this responsibility is borne by the grid operating organisation(s). Some grids are well maintained while others are poorly maintained and/or overloaded, which puts them at increased risk of failure. After the point of metering installed by the grid operator, the operations and maintenance (O&M) of the cold room and other electrical loads is the responsibility of the user.

The quality of grid electricity varies widely from high quality electricity available on well-maintained systems to unstable electricity with widely varying quality on overloaded and/or poorly maintained grids. To sustain cold room equipment, it is advisable to protect cold room equipment with voltage stabilisers and surge protectors in order to avoid damages that shorten the life of equipment. Maintenance of this protection equipment would be the responsibility of the user.

When backup electricity is needed, a battery with recharging system, or a generator (or a hybrid with both) are common solutions. This adds O&M tasks and costs to the users. In some cases, the grid quality will be too poor or O&M burdens too troublesome and an alternative source of electricity may be necessary.

Other miscellaneous factors can impact the power source selection process that are hard to predict and include issues such as avoiding hydropower due to concerns of extended drought and rejection of power generated by fossil fuels on environmental or ethical grounds.

Cost: Life costs of options can be compared where both the initial capital equipment and installation expense (CAPEX) and the ongoing operational expense (OPEX) are considered. When CAPEX is added together with OPEX (calculated over the expected lifetime of the solution), a simple life cycle cost (LCC) can be estimated.

A major advantage to consumers of grid electricity is that there may be no capital expenditure for electric generators or distribution infrastructure. However, in some cases, the consumer may face interconnection costs that can become cost prohibitive when cable extension costs are directly invoiced to the user.

OPEX includes the price charged for electrical consumption (kWh over a billing period) and in some cases the short-term peak demand (kW) during a defined period. Grid electricity can be subsidised by the supplier (e.g. through government regulations), making it affordable, or by a rate structure that rewards 'off-peak' consumption (e.g. night times when other consumer consumption is lower than daylight hours).

In cases where expensive fuels are used to generate electricity grid, electricity consumption costs can become cost prohibitive (e.g. diesel fuel that must be transported over difficult routes to remote location generators).

Other key questions to be addressed are:

1. Is there access to reliable grid electricity with off-peak electricity rates? What is the rate structure for this site?
2. What are the interconnection expenses for the installation site?
3. Is the cost of electricity affordable when compared to income generated (or food supplied)?
4. Is the quality of electricity acceptable or can it be made acceptable for the cold room loads?
5. Can users carry out O&M or are the O&M services provided by others acceptable?

6. If energy storage and/or backup energy is added, can the users sustain the O&M requirements and added costs of these systems?
7. Are there other factors leading to strong objections to grid electricity?

5.2.4.2 Options for off-grid electricity: fossil fuel-fired generators

When grid electricity is not available or not acceptable, the only other supply options are an off-grid electricity system which is either a fossil fuel (usually diesel) generator or a renewable energy solution.

Choosing a fossil fuel-fired electricity generator as the *primary* power source brings not only noise and fumes, but also three significant new risks to the business: total dependence on fuel being always available; required maintenance and eventual component repairs; and the volatility of fuel prices, especially when exploited by unscrupulous suppliers, as the two risks are most often linked. Either risk could shut down the cold room business. The issues and risks to businesses and planet from use of fossil fuel generators are set out plainly in the 2019 IFC report *The Dirty Footprint of the Broken Grid*⁹ and is a source of some material in this subsection. Regarding costs: fossil fuel generators have relatively low initial cost (CAPEX), but operational and life cycle costs are high, highly volatile and often significantly underestimated. Cost estimates for running a diesel generator should include:

1. Capital cost to purchase and install the generator, plus equipment for safe fuel transportation and storage.
2. Fuel to run the generator, including what is wasted and stolen.
3. Operation and maintenance – conservative estimates are around 10% to 20% of the fuel costs in most situations (IFC 2019) along with the need for readily available experienced maintenance and repair technicians with access to spare parts.
4. Opportunity cost of staff time to find and transport fuel (monthly, weekly, daily) and to have generators repaired and maintained (occasional, but likely at busiest times).

Anecdotal evidence confirms that customers choose food stores and markets to avoid the noise and fumes of generators when that option is available; staff can work better and at lower health risk. Diesel generators are a significant source of local air pollution and account for 15% of total NOx emissions in Sub-Saharan Africa (IFC 2019). Fuel and lubricating oils inevitably spill and leak into local ground and water courses. Fossil fuel-fired generators as primary power sources are highly damaging to the environment, both on-site and off-site where fuels are extracted, refined and transported. Diesel generators can, however, provide relatively cheap *backup* for occasional use when the primary source is unavailable for reasons of weather, mechanical/ electrical problems, etc.

5.2.4.3 Relative costs of renewable energy sources

Renewable energy sources include solar, wind, hydropower, biomass, biogas, biofuels, and are all possible energy sources for generating electricity for an off-grid cold room.

The first costs (CAPEX) of renewable energy systems are higher than those of most grid options or off-grid fuel-fired generators. However, prices for renewable options have fallen sharply in recent years. Solar photovoltaic modules have experienced a dramatic decrease in price (82% between

⁹ *The Dirty Footprint of the Broken Grid - The Impacts of Fossil Fuel Back-up Generators in Developing Countries, September 2019, International Finance Corporation. Available from: <https://www.ifc.org/en/insights-reports/2010/dirty-footprint-of-broken-grid>*

2010 and 2021, IRENA, 2022) due to a greater familiarity, growing markets, better technologies, increased competition, and financial incentives in some countries. Similarly, many types of battery system have seen long-term declines in cost – in particular lithium-ion, for which an exhaustive MIT study in 2021 showed that there has been 'consistent decrease in lithium-ion cell price over time' and 'prices have declined by about 97% since the commercial introduction of lithium-ion cells in 1991'¹⁰. Lead acid battery technology has become more sophisticated and demand is rising, which account for price increases in some markets. For example, nano carbon lead acid batteries that warrant longer life as well as the use of Advanced Glass Mat (AGM) batteries that supersede conventional SLA (sealed lead acid) types for many automotive applications. Nevertheless, battery system costs are often the single largest component cost for solar-plus-battery solutions – at least partly due to the very significant drop in price for solar modules and power electronics.

On a large scale, electricity from renewable energy is claimed to be the least-cost option for new generation capacity in most regions (UNDP, 2018). Renewable energies accounted for 73% of all new capacity additions globally in 2021 (IRENA, 2022). In some countries, solar-powered cold rooms are becoming more common.

5.2.4.4 Solar photovoltaic power for off-grid cold rooms

Photovoltaics (PV) is the direct conversion of sunlight to electricity. PV electricity has been widely used for off-grid solutions, including cold rooms and appliance level refrigeration. Integrated solutions with both the cold room and solar electricity system are commercially available. Therefore, the off-grid focus of this guide will be PV solar electricity solutions including combinations of thermal energy storage and/or battery electrical energy storage.

The key advantages of a PV solution for an off-grid cold room include:

- PV is a commercially available technical solution for off-grid cold room electricity.
- PV can provide quality reliable electricity equal or better than grid electricity.
- PV has no fuel operating cost.
- PV can be mounted to provide shade to cold room and adjacent work areas.
- No onsite pollution from emissions, fuel leakage or noise.
- No diesel exhaust fume contamination of products.
- Less maintenance than fuel-fired generators.
- PV modules have no moving parts and long life expectancy.

The key disadvantages of a PV solution for an off-grid cold room include:

- First cost (capital expense or CAPEX) is higher than some competing options.
- Financing is typically a user responsibility.
- Financing may be unavailable.
- Variability of solar radiation requires energy storage system.
- PV array siting in mostly unshaded location may be in opposition to cold room siting in mostly shaded location.
- Specialist PV servicing may not be locally available yet (though this is growing in many areas).
- If used, batteries add maintenance and replacement cost.
- PV module array may need to be cleaned regularly.

¹⁰ See article 'Study reveals plunge in lithium-ion battery costs', MIT News Office, March 23, 2021. Available from: <https://news.mit.edu/2021/lithium-ion-battery-costs-0323>

5.2.4.5 Key considerations when selecting solar photovoltaic as an off-grid power source

Most off-grid solutions will require more involvement by users than a grid solution. Compared to a grid electricity solution an off-grid PV solution adds specialised design work to assure the power system is sized and specified correctly, adds the need for qualified installers (See Subsection 6.1.6), usually requires user participation in maintenance and may add long term commitment to sustainability - especially if costly batteries will eventually need to be replaced. For example, PV is often selected for off-grid needs and the variability of solar radiation must be assessed at the design stage. It is recommended that electricians with PV training be responsible for a safe and successful installation. Users often are responsible for cleaning PV module arrays and trimming vegetation that would otherwise shade the array. If batteries are used, there will be eventual replacement tasks best carried out by trained technicians and if the batteries are of the common flooded lead acid type, there will be ongoing technical maintenance. Battery replacement can be a significant cost and many PV have been considered failures because this replacement cost was not foreseen, not planned for and/or not budgeted for (WHO/UNICEF, 2015).

Reliable, stable off-grid electricity presents the most energy supply challenges. This section will focus on when to select an off-grid electricity system and the key design considerations to successfully design, install and maintain it.

Like the grid electricity selection process, the steps in the off-grid selection process involve addressing a series of considerations to obtain a 'go/no-go' decision. Each major consideration step is described below and is generally based on the path shown in Figure 5.3.

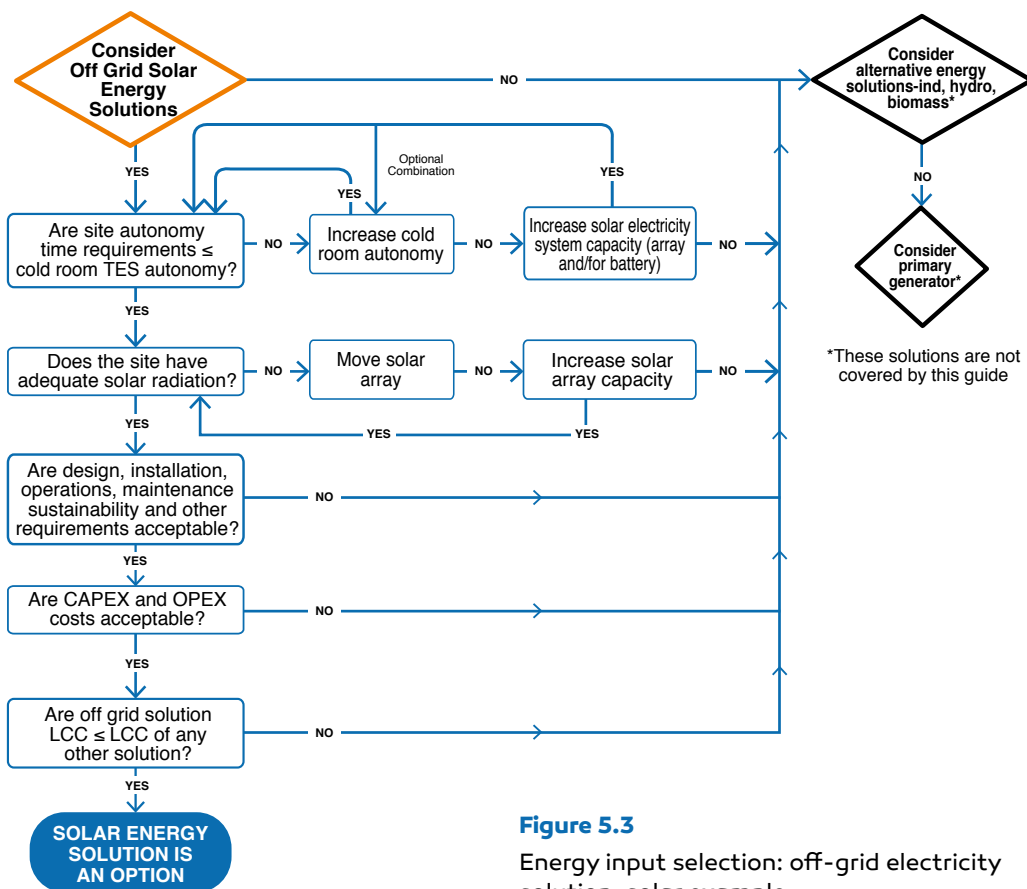

Figure 5.3 Energy input selection: off-grid electricity solution, solar example.

Autonomy

Autonomy is the amount of time that a system (with or without energy storage, either thermal or electric) can sustain acceptable storage temperature with no additional electricity input.

The autonomy time required at a specific site must be known or estimated to establish the design target for energy storage options. Buyer or buyer agent will need to specify if a product is a critical load and provide any additional information on expected autonomy time. The cooling system designer/supplier will need to then provide the estimated autonomy time for any thermal energy storage integrated in the cold room. The PV designer will use this information and site-specific climate data to assure adequate autonomy and PV power is built into the finished system(s).

At a minimum, a PV powered cold room is expected to maintain acceptable storage temperatures overnight when no solar electricity is being generated. However, seasonal cloudiness can last continuously for days-even for weeks in some microclimates - and if temperature-sensitive products need sustained cold storage, then the cold room will need to be designed to maintain the acceptable storage temperature range throughout the autonomy period.

Autonomy can be difficult to predict and can vary from year to year making this variable challenging to confidently prepare for. The designer may need to estimate the duration of autonomy, sometimes without accurate evidence. Autonomy and sources for autonomy estimating tools are described in detail in Section 5.4: 'Solar power system components and design'.

Autonomy of the cold room may be increased by adding increased thermal energy storage (see 5.4). Another option is the addition of PV array capacity to recharge TES more quickly. Conversely, the autonomy needs can be met by using an electrical storage battery to sustain compressor operations for the autonomy time required on site.

The first key question is: does the cold room have TES and are the estimated autonomy requirements for the installation site less than the cold room autonomy time?

Availability

The site solar radiation resource must be adequate to meet the cold room electricity requirements in all months of the year. Solar radiation varies widely from site to site and month to month averages illustrate seasonal differences for the same site. Even a site in a dry, sunny climate with a properly designed and installed solar array may generate too little solar power if the solar array is positioned under shade (e.g. in a forest or adjacent to taller buildings/structures) or allowed to be fully covered in dust, debris or dirt.

Sources for long-term solar insolation data (solar radiation on an area over time) are available to establish the expected site solar resource (Global Solar Atlas). However, the designer will also need to establish that the installation site is suitable (i.e. solar insolation data indicates adequate solar during the design month and shading is not extensive). This is detailed in Section 5.4: 'Solar power system components and design'.

Second key question is therefore: does solar radiation data indicate an adequate solar resource in the general area of the site and is specific site shading acceptable? If not, some changes should be done to size, orientation or shading of the solar array.

The need for preparation and advice

Design, installation, sustainability, Operations and Maintenance (O&M) must be acceptable. The quality and reliability of off-grid solar electricity can be equal to – or even more stable than – grid electricity. However, it is imperative that all involved are adequately prepared to contribute toward sustained success leading to a quality reliable solar electric system.

Off-grid system design and installation is a specialisation that requires training beyond typical electrician training, which, historically, has been focused on grid electricity systems. O&M includes all facets of generating, supplying and maintaining the entire electricity supply and energy storage system(s), including all the cold room loads. Training of technicians and users is often required to enable them to operate, maintain and repair an off-grid solution. These are much greater responsibilities than with grid solutions and must be carefully considered to assure all aspects can be managed successfully.

Cost considerations

Life costs of options can be compared where both the initial capital equipment and installation expense (CAPEX) and the ongoing operational expense (OPEX) are considered. When CAPEX is added together with OPEX (calculated over the expected lifetime of the solution) then a simple life cycle cost (LCC) can be estimated.

The LCC of any solution can be compared to other competing solutions. Often the LCC of solar electricity is lower than the LCC of a standalone fuel-fired generator or unreliable grid. However, the LCC of a reliable grid with affordable electricity is often lower than the LCC of any other option.

Financing of the CAPEX of any standalone electricity solution is often a major disadvantage, especially where financing is not available. When a large battery is included, it will often be the single most expensive CAPEX component as well as the single largest OPEX expense. Increasing the solar array capacity is one strategy to reduce battery and utilising sufficient thermal energy storage can reduce or even eliminate the need for large batteries.

While the OPEX of solar electricity is usually low (i.e. no fuel or energy cost) the eventual replacement cost of the battery can be significant. If not replaced, a failed battery often leads to a failed solar power system. For this reason, it is recommended that the design utilise thermal energy storage to reduce or eliminate large batteries required to provide long autonomy needs.

Key questions about costs are then:

- Is the first cost (CAPEX) affordable? If not, is financing or other financial support available?
- Are the ongoing costs (OPEX) – including any battery replacements or fuel costs – sustainable?
- Is the Life Cycle Cost (LCC) of the solar electricity solution equal or less than the LCC of another acceptable alternative?

It is recommended to compare both the grid and the off-grid selection processes to consider advantages and disadvantages of each, and then carry out an LCC analysis to determine the most appropriate energy input source(s).

Other considerations

Before settling on an off-grid power source, consider also these questions:

- Can the off-grid solution be successfully designed, installed, operated, and maintained on-site with the available team?
- How will battery replacements be paid for?
- What is the lifetime expected for PV modules and inverters?
- Could it be more economically viable to consider DC-powered compressor?
- Are there any other factors that are serious objections to the off-grid solution?
- Has the system power sizing taken good account of any need for precooling of produce before storage (see Subsection 2.3.2)?

5.2.5 Site Electrical Requirements Worksheet

For each site, the buyer (or buyer's agent) will provide prospective suppliers with as many details as possible with a completed **Site Requirements Worksheet**. To assist in consolidating and organising the information needed by the power system designer/supplier, a Site Requirements Worksheet is provided below.

Step 1: Obtain the following information:

- Location of installation.
- Type and size of the cold room.
- Autonomy with TES if available.
- Electrical loads (energy use, peak power requirements as calculated by the cooling equipment designer/supplier). Confirm that all electrical loads have been included (see Section 4.7).

Step 2: Use 'Energy Input Selection' flowcharts (Figure 5.2 for grid connected sites and Figure 5.3 for off-grid sites) to determine the energy supply source(s) most appropriate for the specific installation site.

Step 3: Complete the Site Energy Requirements list below (Table 5.1).

Table 5.1

Site energy requirements list.

Site Details
GPS Coordinates or latitude and longitude Is there grid electricity? If yes, then note: <ul style="list-style-type: none"> • Any reports of outages and their frequency and duration. • If it is reliable (22 hr/day), unreliable or limited (note hours of available electricity). • If there is an off-peak rate structure (specify rates). Is the site unshaded 8AM-4PM? If no, describe shading challenges or solar array placement options. List site special needs and brief description of importance (e.g. seasonal variations in cold room usage, site microclimate, windstorm, seismic area, marine environment, theft deterrence, solar array attached to cold room, solar array to be ground mounted xx meters from cold room, etc.). Are the products to be cooled considered critical (require continuous acceptable storage temperatures)? If so, please describe the temperature requirements and time(s) of the year they are required.
Cold Chain Requirements
Type of room (cold, freezer, or combined cold/freezer). Placement (standalone room or sheltered in larger building). What is the expected maximum ambient temperature on site and at which month? How many hours of acceptable storage temperature autonomy will be needed after power cut or poor solar weather (e.g. 2 hours, overnight, 1 day, 2 days, 3 days, etc.)? Is thermal energy storage included with the cold room? (if yes, how many hours of autonomy are provided)?
Cooling System Electrical Requirements
Cooling system type and electrical specifications (voltage, frequency, phase). Electrical Load Consumption (typical, minimum and maximum worst case, may vary by season): (kWh/day - note at xx ambient temperature and note month, from cooling equipment designer/supplier, see 4.6). Electrical Power Requirement (typical, minimum and maximum worst case, may vary by season): (kW peak, note at xx ambient temperature and note month, from cooling equipment designer/supplier. See 4.6). Primary power (solar, reliable grid, limited grid? If other, specify). Backup electricity (none, generator, battery or hybrid? If hybrid, specify primary and secondary sources).

5.2.6 Overview of energy storage (electrical and thermal)

Energy storage is an extremely useful strategy to assure acceptable storage temperature can be sustained when needed. Energy storage can be electrical or thermal, as well as hybrid with both.

However, cold room designs that minimise the need for electrical storage batteries will reduce a major obstacle to reliability and sustainability in all applications. The introduction of batteries brings on recurring costs and burdens for battery maintenance and replacement. A decades-long experience of deploying refrigerators and cold rooms for vaccine and health supply chains in remote regions by the World Health Organisation and UNICEF have led their procurement experts¹¹ to minimise and even try to eliminate use of batteries. This was driven largely by highly problematic in-field repair and replacement of many types of battery system in the medium to long term, leading to failure of cooling services. Nevertheless, having a small but reliable battery to ensure continuity for critical low power functions will often be better than having no battery at all. Preparation and planning should be set in place to make replacement of that battery possible for when that time comes. This could include: providing user instructions; choosing a common type and size of battery with multiple suppliers; providing a written specification for the battery, marked permanently on the system; making it easy to find and exchange the battery (no or few tools required); and listing possible suppliers.

Minimising energy consumption requirements of the cold room structure, lighting, electronic and mechanical equipment will support minimising costs for energy storage as well as other mechanical and electrical components. The cost of equipment for electrical energy storage is typically five to in excess of twenty times more expensive per kWh of energy stored than that for thermal storage, though many factors are at play in such comparison. A Lithium-ion battery plus charger is typically more expensive in 2023 than most lead acid batteries, whereas cost of a heat exchanger for ice thermal storage is at least one order of magnitude lower. We have to consider also that Lithium-ion batteries have a lifespan of around 10 years and lead acid significantly less, whereas thermal storage significantly more.

The type and capacity of any energy storage system (thermal or electrical) will need to match the energy input source, the load needs and the estimated autonomy. Reliable grid can use energy storage to reduce operating costs. One example in use today is where TES is used to shift the electricity consumption to hours when the grid electricity supplier charges a lower rate for electricity. The TES is sized to provide autonomy through the hours of higher rates (at a minimum) and then be recharged during periods of lower electricity cost.

Limited grids can use the same strategy to sustain cooling during time when the regular supply of electricity is unavailable. For example, where electricity is reliably provided over a set time period, energy storage can be sized to be recharged during the time when electricity is available and then provide cooling autonomy for the remaining time when the grid is known to be unavailable. One example is a village generator that is scheduled to supply power for 5 hours per day. An energy storage system can be sized to provide a minimum of 19 hours of autonomy and be recharged in just 5 hours. Additional energy storage may be added to overcome other longer supply disruptions that can be reasonably predicted.

Off-grid cases using PV have two autonomy needs – the regular overnight hours when PV generation is not available as well as prolonged periods of low solar insolation (e.g. cloudy days with rainstorms that can last several days or more). A 'battery-free' solar cold room will need to have thermal energy storage (TES) autonomy of several days in many tropical locations where cloudy, rainy weather coincides with the season(s) when product requires sustained cool storage.

¹¹ See WHO PQS programme, for example at https://apps.who.int/immunization_standards/vaccine_quality/pqs_catalogue/categorypage.aspx?id_cat=15

A battery-based PV cold room can do the same by relying on batteries. One advantage of a battery-based PV system is that the battery can also help start compressors earlier than a battery-free PV cold room. Blending the two energy storage options is a strategy that can reduce battery vulnerability and cost and rely on long life cold TES to provide most of the autonomy time needed. Once the TES is depleted and the cold room warms to the compressor cut in temperature setpoint, the battery autonomy will be used for cooling equipment functions.

5.3 Solar energy applications

Solar energy, when used for appropriately matched applications, can be the most economical energy supply solution. For example, solar energy is free of ongoing energy costs (e.g. in building design that utilises natural daylight instead of electric lighting). Another example of economic advantage is found where no electricity is available at a remote site and the life cycle cost (LCC) of photovoltaic (PV, also called solar electric) generation is less costly when compared to competing options like a diesel fuel generator that brings ongoing costs for fuel, its transportation plus operations, maintenance (O&M) and regular repairs. In some cases, solar is more reliable than other sources, especially in an area with unreliable electricity that is subject to unpredictable and prolonged grid power outages. And renewable energy like PV is more environmentally responsible than other options utilising a fossil fuel energy source (coal, oil, gas) to generate electricity.

Global applications using solar energy are readily found and broadly include solar electricity, solar thermal and building integrated features such as the deliberate use of natural daylighting and ventilation (passive solar).

Of special interest are **agricultural applications** of solar thermal and PV that include heating, pumping, lighting, ventilation, as well as solar drying and cooling for vegetables, herbs, fruits, flowers, milk, meat and fish.

Photovoltaics (called 'PV') is the direct conversion of sunlight to electricity. PV has widespread applications that range from small kits with a few watts (W) of solar cells (e.g. portable solar lighting) to millions of watts (MW) in a solar power plant serving a grid system. While solar concentrators can also be used for generating electricity, this section focuses on PV as used today to supply electricity for walk-in cold rooms for product preservation and storage (Figure 5.4).

This section will highlight many of the best PV practices that have evolved over the last 40 years. Solar electricity is a specialisation, and it is possible that an integrated package including cold room and power supply can be purchased from a single source. It is also possible that the power system be supplied by one experienced PV company while the cold room is supplied by another specialised company. While it is also possible to assemble the individual components and build a customised system, this is not typical and not recommended for most applications¹².



Figure 5.4
Application of solar energy to a cold room (Inficold).

¹² *Off-Grid PV Systems: Design and Installation (Global Sustainable Energy Solutions, 2022)* <https://www.gsesinternational.com/product/off-grid-pv-systems-design-installation-ebook/>

Solar thermal (heating) applications are found in many countries and are most often used to heat water and buildings, and sometimes drive processes including absorption cooling, but niche applications are food cooking, kiln drying and desalination of water. All these applications can be either passive solar (no added energy input for electrical or mechanical device required) or active solar (additional energy input and devices required). Passive solar applications are integrated into structures. Examples include daylight used during daytime to light buildings and passive cooling (or heating) of air to ventilate and condition building temperatures. No additional energy input is required for passive solar applications (Figure 5.5).



Figure 5.5

Natural circulation passive solar system vs forced circulation active solar system for hot water production.

5.3.1 Types of PV systems used for cooling

Since the 1980s PV has been successfully used to supply electricity for refrigeration. To a far lesser degree, solar heating has been used to drive absorption cooling, i.e. refrigerators based on the absorption process, which need heat for their operation.

The general types of PV systems are:

- Standalone off-grid that operates independent of any other source of electricity (i.e., does not use utility grid).
- Hybrid – a combination of two or more energy sources (e.g. PV plus backup generator).
- PV mini-grid – PV system or PV hybrid system connected to a distribution network for a local group of customers. Mini-grids can operate as a reliable or a limited grid. (**Note:** This guide does not specifically address solar mini grid applications).
- Grid tied – PV system that requires interconnection with an electric grid. (**Note:** This guide does not address cold rooms that are PV grid tied).

5.3.2 PV system components

A PV electricity supply system includes a group of integrated components with functions including electricity generation, distribution, control/conditioning and, usually, energy storage.

Common components of a PV system and their principal functions are:

- *PV module (also called solar panel)*, the basic solar electricity generator (called 'module').
- *PV array*, group of interconnected PV modules to generate electricity wired to achieve the necessary voltage and power required by the overall system (called 'array').

- *Mounting structure* to secure individual PV modules and cabling (called 'mounting structure').
- *Electrical wiring* to transport electricity throughout the entire electrical system (called 'wiring').
- *Circuit breakers and fusing* to protect wiring and components (called 'overcurrent protection').
- *Energy storage* that can be either electrical (called 'battery') or thermal (called 'TES', Thermal Energy Storage).
- *Enclosures*, protection for electrical wiring and battery (called 'enclosure').
- *Battery charge regulator* (also called charge control) to manage recharging and protect a battery (called 'regulator').
- *Inverter* to convert direct current electricity (called 'DC') to alternating current electricity (called 'AC') when AC compressors are used (called 'battery inverter'); it is not needed for the operation of low voltage DC compressors.

Each PV system component will be discussed in the detail necessary to enable the reader to recognise the key considerations and questions to be asked to the system designer/supplier to assess solutions offered.

5.3.3 PV electricity system configurations

5.3.3.1 Solar Direct Drive (SDD)

The simplest standalone PV systems are solar direct drive (called 'SDD'), where a PV array is wired directly to a load (e.g. array wired directly to a fan motor, pump motor or wired to a refrigeration compressor system). There is no battery in a SDD system but it may include thermal energy storage for cooling loads. SDD vaccine refrigerators have built-in cold thermal energy storage and are widely used to entirely eliminate battery burdens (Figure 5.6).

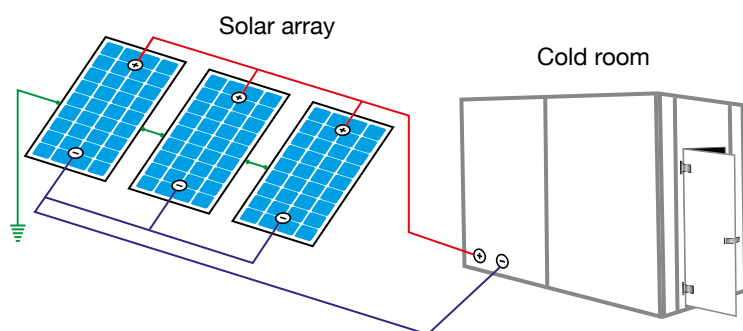

Figure 5.6

Top: A battery-free, solar direct drive system has few key components if the appliance is suitably designed (an SDD chest freezer in this case).

Bottom: a remote-located solar module array.



SDD operation: SDD loads can only receive electricity when there is adequate solar radiation. This limits SDD either to applications that operate only during the day (e.g. ventilation fan) or to applications with product or energy storage. Water pumps were the first commercial SDD applications to pump water into a storage tank for availability at any time. SDD vaccine refrigerator development started in the late 1990s and they now dominate the solar vaccine market. The first commercially available battery-free SDD walk-in cold rooms are available on the market.

Compressors require an electrical power input to start that is higher than the running power and the PV array must be able to generate the starting power. This limits compressor run time, especially in early mornings, late afternoons, and cloudier times when the available power level may not be sufficient. When the electrical starting requirements are not met, the SDD load relies on thermal energy storage to bridge this gap until the array once again produces adequate power to restart the compressor and recharge the thermal energy storage. In order to obtain sufficient compressor run time, SDD PV arrays tend to be oversized and often over half the electricity generation is not utilised unless an 'energy harvest control' is added to divert the surplus electricity to other loads (e.g. loads using rechargeable batteries or other SDD motor loads like an SDD freezer).

5.3.3.2 Battery-based PV

Battery-based systems are often used as a standalone electric supply.

When a load requires instant electricity, a battery is required (e.g. at night or when a compressor requires a short burst of high energy to start up). Battery-based PV can power DC loads, AC loads (with the addition of battery inverter) or both DC and AC loads. Batteries have losses, not all the energy supplied is stored, and losses occur also during standby.

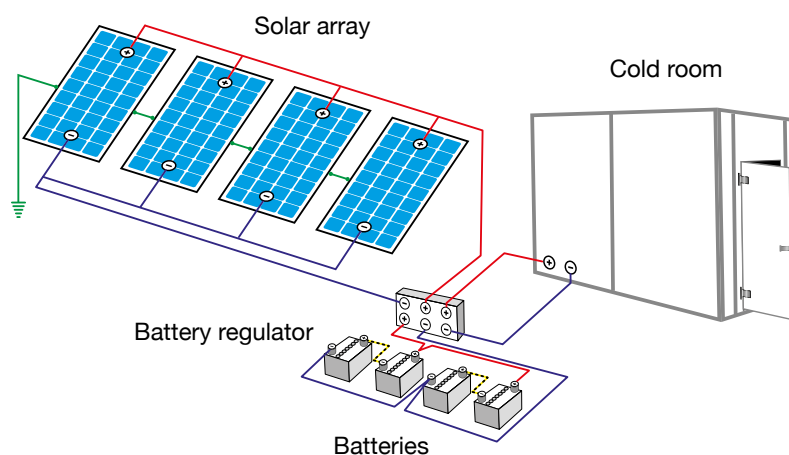

Figure 5.7

Key components of a battery-based PV system for a DC load.

Battery systems require a regulator to protect the battery, which also introduces some system efficiency losses. In many cases the battery provides DC electricity to loads such as DC compressor, DC fans, DC pumps, DC temperature monitoring and DC lights (Figure 5.7). But when loads need AC power, an inverter adds further losses (inverter efficiency varies from 75% to 95% depending on quality). These losses in inverters and batteries can mount up to 10%, 15% or more and PV and battery sizing must take this into account (Figure 5.8).

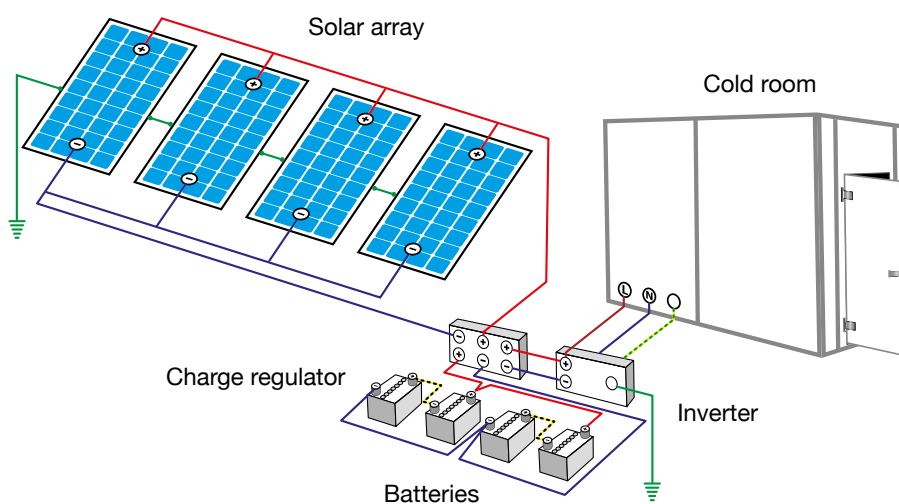

Figure 5.8

Key components of a battery-based PV system for AC loads.

Battery-based PV systems operations: Compared to SDD, these are more complex systems but can supply electricity continually all day and night from the electricity generated and stored chemically in a battery. During the day the PV array will generate direct current (DC) electricity. As sunlight intensity increases more electricity can be generated. The electricity can be consumed immediately by the load and if excess electricity is available, it is stored in a rechargeable battery. As the battery is increasingly recharged, the battery charge regulator senses this by constantly monitoring battery voltage and reducing the current drawn to suit. This does not harm the array and protects the battery from overcharging damage. When the cold room consumes stored electricity, the battery voltage falls and the regulator allows current through to recharge the battery.

At night, the regulator disconnects the array since no electricity is being generated and to prevent the battery from losing electricity backwards through the array. A regulator with an optional low voltage disconnect (LVD) connects the cold room DC loads to the battery and will switch off the flow of electricity if the battery voltage drops below a preset level. The LVD will switch on the flow of electricity to the load when battery voltage is high enough. This protection can greatly increase battery life and is strongly recommended to be included in a PV battery system with DC loads.

When the load requires AC electricity, a battery inverter converts DC electricity (i.e. generated by the PV array and stored in the battery) into AC electricity. Battery inverters are available to produce all common voltages and frequencies (e.g. 230 VAC 50 Hz, 120/240 VAC 60 Hz). Both single phase and three phase inverters are available.

Most inverters will automatically disconnect if battery voltage falls too low. Numerous inverter options are available, e.g. an integrated battery charger that could be connected to a secondary energy supply source, such as a temporary fuel-fired generator or to a fixed grid supply.

During cloudy periods, the array produces very little electricity. During these periods, the battery provides nearly all the required electricity to the load. This discharges the battery until sunny weather returns. To assure operation of the electrical system during periods of low solar radiation, a battery is sized to store sufficient electrical energy to sustain operations for an estimated number of hours or days (called 'autonomy'). When passive thermal energy storage is included in a cold room, the battery autonomy time will be decreased and a smaller battery capacity will be justified.

All PV arrays are sized to meet a predetermined load (i.e. consumption of kWh/average day or kWh/design day). If the PV array electricity is diverted – or used for other loads (e.g. personal use) – the batteries and PV array may not be sized to provide the additional electricity. Overuse of the PV system will likely discharge the battery, possibly damaging the battery or causing an inverter or regulator with an LVD to switch off the flow of electricity to the load possibly causing damage to the foods stored in the cooler.

Autonomy: Battery autonomy time will depend on the amount of thermal energy storage in the cold room, the climate and importance of sustaining load power. A load that is considered critical should have adequate autonomy to overcome the longest continuous periods of low solar radiation (e.g. overcast, rain). Conversely, a load that can tolerate some periods of no electricity will need less autonomy. It is possible to prioritise the battery powered loads so that noncritical loads are disconnected before critical load disconnection. For a cold room prioritisation can initially disconnect all non-essential loads to conserve battery storage to prolong critical cooling system operation: whilst charging of phones, computers and running external lights is a useful benefit to such a system, unless this demand is considered in the design, it will leave the refrigeration system with insufficient power to achieve the necessary autonomy.

5.3.3.3 Hybrid PV

A hybrid solar power system uses two or more sources of energy inputs. Energy inputs can be an electrical input solution (e.g. PV and generator) or energy storage solution (e.g. battery and TES). A generator adds logistical challenges and on-site fuel pollution – see the downsides to fossil fuel generators explained in 5.2.4.2. However, a generator can be used to cover occasional peaks in demand and so reduce the PV array size and the battery capacity required to overcome extended periods of low solar radiation or seasonal peak load demands. This can increase system reliability, as long as the downsides to diesel generators are understood and tolerable. Energy storage can also be a hybrid where both an electrical battery and TES are combined to assure the load is kept at an acceptable storage temperature throughout the required autonomy period.

Hybrid PV system operations: PV hybrid systems are typically designed for the electrical load to be supplied with a battery-based PV electricity system and a fuel-fired generator acting as the secondary, backup power source. A hybrid PV system is sometimes intended to overcome 'worst case' climate conditions that otherwise will require a larger PV array and/or larger batteries. For example, an area with a distinct short term seasonal microclimate with prolonged cloudiness would require a very large, costly battery sized for the prolonged cloudiness that may only last for several weeks each year. Alternately, the load could be met with a smaller PV system and some reliance on the generator through the prolonged cloudy period.

The addition of a fixed generator has numerous disadvantages including added first costs, increased complexity, increased safety risks, more logistical efforts, fuel costs, frequent maintenance, pollution from noise and combustion (e.g. greenhouse gas emissions, fuel leakage to ground and fuel transportation impacts). For these reasons, it is recommended to avoid the introduction of a fuel-fired generator unless absolutely necessary.

Often, an inverter can be purchased that has an optional integrated battery charger. Adding a convenient generator input connection enables hybrid operation with a portable generator. This approach allows for emergency battery recharging from a portable generator that can be shared for other uses, thereby avoiding most of the initial costs and maintenance of a fixed generator.

5.4 Solar power system components and design

This section focuses on what the readers, the users and the designers/suppliers can do to get the best performance from a PV system. Each PV system component will have a number of ways of optimising and sustaining performance.

5.4.1 PV modules

5.4.1.1 Overview

Photovoltaic modules are designed to convert solar energy to electrical power through the photovoltaic effect. There are generally rigid rectangular panels, but some semi-flexible ones based on thin-film cells are also available. They are electrically connected in parallel/series to form arrays (Figure 5.9).

The PV module (also called solar panel, solar module) is a generator of direct current (DC) electricity. A PV module has no moving parts. However, some installations may utilise module array mounting systems on a solar tracker in order to increase the energy produced. These systems are capable of sensing the direction of the Sun and tilt or rotate the module array as required for maximum exposure. However, this kind of installation has high costs which are not justified in countries with high availability of solar radiation.

Solar modules were initially built to be rocketed into space to provide long-term, reliable electricity for satellites. This level of durability has led the PV module to become a leading renewable energy electricity generator with one of the longest warranties of any product available (quality modules carry power warranties of 25 to 30 years). As prices for PV modules have fallen, they are now widely used around the globe.

The main factors that affect the amount of electricity generated by an array of PV modules will vary depending on:

- The **power rating** of the solar module.
- The **local climate** including solar radiation and temperature.
- The solar radiation reaching the array.
- The connected load.

These are considered in the subsequent sections, followed by considerations for PV array losses and PV module warranties.



Figure 5.9
Array of solar PV modules
(Promethean).

5.4.1.2 PV module power rating

Quality solar modules are rated using an internationally accepted method to allow fair comparisons of competing modules. The rating method is based on an internationally accepted set of 'standard test conditions' (STC) that present a power rating in Watts peak (Wp) when the solar radiation equals 1000 Watts per square meter (W/m^2) with the air temperature at 25°C. The STC is used as a common basis rating of PV module performance for all types of PV modules used to date (i.e. polycrystalline silicon, monocrystalline silicon and thin films of various compositions including amorphous silicon).

Other electrical ratings used to size a PV array are also reported for quality PV modules. Here is a short summary of selected specifications designer/suppliers will consider:

- Peak power at STC (Wp)
- Solar module efficiency (%)
- Volts at peak power rating (Vp)
- Amps at peak power (Ap)
- Temperature coefficient (adjusts output based on cell temperature)
- Mechanical specifications that are used to dimension a solar array
- Cable type and electrical connection
- Number of bypass diodes
- Wind/snow load rating
- Warranty

Quality solar modules will present this information (and more) on a specification sheet that will also provide warranty information as well as declarations of compliance with international standards (e.g. IEC 62125 for safety and quality requirements). It is very important to receive a PV module specification sheet published by the original equipment manufacturer.

In operation, the solar module rarely operates at the STC so designers must account for several variables to accurately predict the power output of a PV array.

PV module efficiency is useful information, especially when space for the array is limited. Monocrystalline modules are usually slightly more efficient than polycrystalline modules. A larger difference is seen between thin films and crystalline silicon modules. A more efficient module will require less solar array area and may therefore be a better fit to cold room roof area. It is also important to note that a low efficiency PV module technology (e.g. amorphous silicon) can result in additional mounting structure costs and more cabling interconnections when compared to crystalline silicon modules. Environmental considerations should also be taken into account when choosing a PV system. In fact, the majority of CO₂ emissions for such a system comes from their manufacturing, so the choice of materials and the options for re-use or recycle at the end of life are key points for the reduction of greenhouse gases released into the atmosphere (Efficiency for Access, 2023). Cabling connections should be kept to a minimum for reliability.

5.4.1.3 Local climate

Solar radiation and air temperature varies from location to location and will vary by seasons as well. Records of long-term weather data can provide an indication of monthly average temperatures (minimum, maximum and average) and solar insolation (solar radiation on an area over time also called irradiance). This data will be used by the designer/supplier to estimate thermal load due to ambient air temperatures as well as power output based on solar data.

Both long-term measured solar data and synthetic solar data are widely available. The best practice is for designers/suppliers to utilise long-term measured data (if available for a nearby or comparable site).

Synthetic data has been developed and can be considered when no measured data from nearby, similar locations is available. The data is often given as an average daily value for each month in the units of kWh/m²/day averaged over a month. This data is also called “peak sun hours” and is defined as the equivalent hours per day when solar insolation averages 1000 w/m². PV modules are rated at standard test condition that is also equivalent to solar insolation of 1000 w/m². Peak sun hours and STC module ratings both use the basis of 1000 W/m² and this conveniently allows designer/suppliers to estimate the site specific amount of solar electricity that would be generated by a specific solar module array over an average day of a given month. Any location that receives less than 3.5 peak sun hours per average day (in any month) should be considered as marginal and will require extraordinary review by a qualified designer/supplier.

Note that while measured solar data is the preferred data for design, a site may experience a localised microclimate that is not captured by solar data measured at another site or by synthesised data.

5.4.1.4 Solar radiation reaching the PV array

The amount of solar that reaches the PV array will also depend on the array tilt angle and orientation. The minimum tilt angle recommended is 10 degrees from horizontal to allow for rain and water to clean an array and runoff without build up at module edges. Tilt angle selection is dependent on latitude and knowledge of monthly load requirements as well as the monthly solar radiation (see Table 5.2 for tilt angle comparisons).

It will also be necessary for the designer to know the level of site-specific shading and soiling that will reduce the output of the array. Shading can reduce the output of a solar array significantly and must be avoided as much as possible. A small shadow on a single PV module can have a large impact in reducing the array output. PV modules with bypass diodes help to reduce the impacts of shading. Shading can also create a ‘hot spot’ on the solar module that is a potential fire hazard. Bypass diodes are intended to direct the flow around the shaded area and prevent the hot spot. PV modules with bypass diodes are therefore an essential requirement for a safe installation.

A representation of shading losses is illustrated in Figure 5.10. The unshaded PV module (on the left) has no power loss and none of the 3 bypass diodes are therefore engaged. The middle module shows tree shading on portions of 3 cells (of 72 cells) and one bypass diode routes current around the shaded string with power loss of 33%. The module on the right shows tree shade across 18 of the 72 cells and all 3 diodes route power around the module with 100% lost.

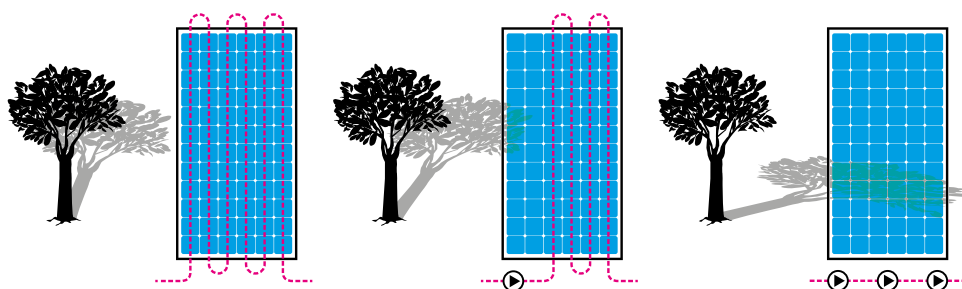

Figure 5.10

Note the shadow falling from the tree onto a 72-cell solar module with 3 bypass diodes.

Left case: no shadow and whole module powered; **middle:** shadow causes first bypass diode to engage; **right:** all three bypass diodes engaged. (*unpublished Solar Refrigeration Training Manual, Pan American Health Organization, FGL/IM-PAHO, 2016*).

Shading can be caused by adjacent structures and vegetation. To avoid shading from fixed structures, the buyer/user may need to find another location for a cold room with an 'attached' PV array or utilise a 'detached' mounting option (e.g. detached pole or ground mount located away from the shaded area). To avoid shading from vegetation trim it or remove it. If trimming is used, this will become a recurring maintenance task that must sustain the unshaded result.

While shading can be intuitively assessed 'by eye' this method may only be useful for sites with very little shading early and late in the day. Best practices are to assess the site with the aid of handheld instruments used on site or using a web-based applications (many are now available). One approach provides sun path diagrams with onsite user inputs that indicate shading loss divided by the half hours of the day. For example, using a sun path diagram for the equator (latitude 0 to 5 degrees) to assess shading losses, it can be estimated that:

- If unshaded from 7AM through 5PM, a PV array will only lose 2% of the daily total solar radiation.
- If unshaded from 8AM through 4PM, the loss totals 8%.
- If unshaded from 9AM to 3PM, the loss is 22%.

Best practice is to select a site where there is presently no shading of the PV array and no expected changes that would shade the array. A good site is unshaded from at least 8AM to 4PM.

Like shading, soiling can block solar radiation from reaching the solar cells in a module. Soiling occurs from dust build up, bird droppings, pollution residue, mould growth and debris such as leaves and trash. Rain can help self-clean soiling in some climates, but many climates will require solar array cleaning maintenance. Flat mounted solar arrays will require regular cleaning even in climates with regular rain. Arrays should be mounted to facilitate regular cleaning maintenance (Figure 5.11).



Figure 5.11

PV module arrays require cleaning in many climates to remove soiling that will reduce the solar radiation reaching the solar cell (photo: Solar Electric Light Fund).

For standalone systems the PV electricity supply must be sized to match the load demand. In order to do this with the smallest, lowest cost system, the solar array must be able to provide adequate power in the worst month for solar radiation unless the load dictates that another month be used for design purposes.

The amount of solar radiation falling on a PV array will depend on site location (Figure 5.12), array tilt and orientation, time of year and weather. Table 5.2 illustrates the seasonal differences in solar insolation and the effect of array tilt angle. The table shows solar radiation (measured as average daily kWh/m²/day or 'peak sun hours') for three PV array tilt angle variations equal to either latitude, latitude minus 15° or latitude plus 15° (for New Delhi, India at latitude 28.70° North). The array is oriented toward the equator (e.g. south facing for New Delhi, India).

Table 5.2

Peak sun hours (kWh/m²/day) at different tilted surfaces for New Delhi, India (28.70°).

PV Array Tilt	March	June	September	December	Annual
13°	6.22	5.87	5.21	4.27	5.33
28°	6.46	5.43	5.24	4.97	5.48
43°	6.33	4.80	5.01	5.38	5.34

Typically, to receive the most solar energy a fixed PV array will be sloped and facing the equator where the tilt angle is usually determined by latitude. A careful review of Table 5.2 shows that a solar array tilted at an angle from horizontal that is equal to latitude will produce the most electricity in the year. However, if the cold room electrical load were to be greatest in June the solar array that is tilted at latitude minus 15 degrees (13 degrees) receives the most solar energy. For winter peaking loads (e.g. December) then the tilt of latitude plus 15 degrees (43 degrees) is optimum. For March or September peaking loads there is little difference between the three tilt angles.

A month-by-month load estimation can be calculated by the designer and then compared to solar radiation data sources to assure that not only the month(s) with the highest load can be met by the designer-specified solar array, but the worst months electricity generation is still adequate to meet the load during that month. Solar sizing software will often display this graphically.

There are many sources for solar radiation data including:

- Global Solar Atlas V2.7, June 2022, World Bank <https://globalsolaratlas.info>
- National government solar maps or handbooks
- NASA POWER Data Access Viewer <https://power.larc.nasa.gov/data-access-viewer/>
- Autonomy Calculation Tool, WHO PQS https://apps.who.int/immunization_standards/vaccine_quality/pqs_catalogue/catdocumentation.aspx?id_cat=17
- Commercial sources, Solar GIS, Meteonorm, 3-Tier, etc.

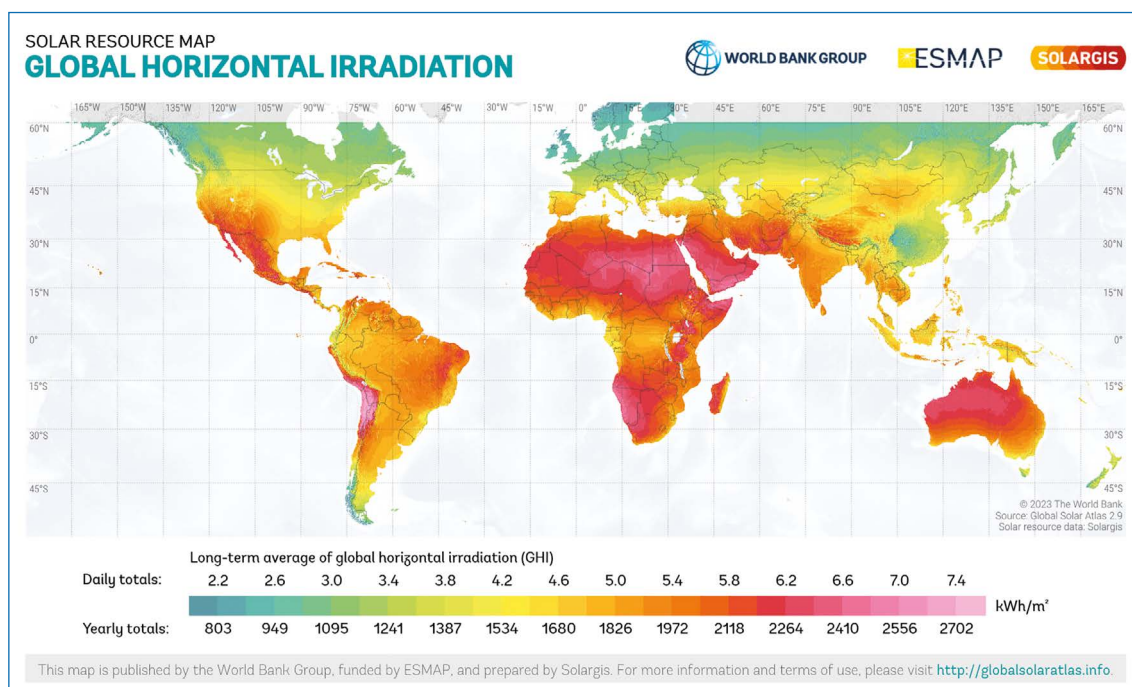

Figure 5.12

Solar Resource Map (*Global Solar Atlas, World Bank*).

5.4.1.5 Connected load to the PV array

The load that is connected to a PV system will impact the efficiency of a PV array. Solar direct drive motors (e.g. compressor) will require a minimum level of electricity to start the motor and this can waste much of the array output during early and late day hours when the solar intensity is too low to start the motor as well as times of cloudiness too low to sustain motor operation. An energy harvesting control can be added to utilise unused electricity and divert it to other loads.

In cases of battery charging a battery charge regulator will switch the load on and off as the voltage changes. Maximum power point tracking controls can better match the array to the load to improve efficiency and in some cases allow for smaller diameter electrical cabling as well.

5.4.1.6 Array efficiency losses

Several factors can – and will – reduce the amount of power from the array. Key factors and typical values have been published (IEEE 1562, 2021) and generally include:

- Solar module aging (20% over 25 years).
- Soiling (1-20%) can be due to dirt, dust, debris, mould, bird droppings and snow – all will block sunlight and must be removed to sustain power output).
- Battery charge and discharge efficiency (1-20%).
- Battery charge regulator (1-5%).
- Shading from adjacent structures and vegetation (requires site assessment, can be significant).
- Heat: the hotter the module the lower voltage.
- Wiring (0-5%) presents some resistance and will reduce voltage to some degree.
- Module mismatch (0-5%).
- Battery inverters will increase system losses 10 to 20% depending on inverter to load matching.

5.4.1.7 PV module warranty

PV module warranty has typically two parts: a product quality warranty and a power warranty. The product quality warranty covers manufacturing defects and ranges from 1 to 25 years. The power warranty covers the power output over time and crystalline silicon modules typically degrade about 15 to 20% over a 25-year span. The lifetime of a module can be 30 years or more and power warranties of quality modules is typically 25 years for crystalline silicon solar modules. Look for the longest warranties from an original equipment manufacturer with a good reputation for making PV modules meeting international norms (e.g. IEC 61215 for crystalline silicon modules).

While PV modules can last for decades, they also can be damaged (e.g. windstorm). Because a specific PV module model may no longer be available, consider purchasing a spare PV module for unexpected damage or theft.

5.4.2 PV array mounting structures

5.4.2.1 Types of structure

General types of PV array mounting structures for cold rooms are (Figure 5.13):

- Attached to the cold room
- Detached on the ground
- Detached on a pole; and
- Detached on a nearby building

Ask your supplier if the PV array mounting is:

- Made of metal
- Designed for the site wind (and/or snow load)
- Designed for adequate corrosion protection for the site conditions; and
- Supplied with theft deterrents for all accessible fasteners

The mounting structure is a key component and should be able to last as long as the solar module (25 years or more). Best practice is for a metal structure to be securely installed in straight, even planes. Even a slight warping of a PV module can cause its failure and warping can be caused by uneven metal structures or twisting wood. For this reason and to avoid possible deterioration, wood structures are not recommended. Metals will need to be corrosion resistant based on the site-specific conditions that could range from salt air marine environments to dry locations. In all cases, avoid corrosion on the fasteners caused by contact between dissimilar metals known to cause corrosion.

The structure will secure the PV module in a fixed direction (i.e., compass orientation and tilt angle from horizontal). Structures must allow ventilation of the PV module underside, or the module will overheat and loss voltage and may discolour and degrade in performance. The structure is also used to secure wiring and certain outdoor rated electrical devices. Unprotected structures near ground level attract larger animals to scratch themselves. Birds can nest under or on arrays and their droppings can shade a PV module and add to maintenance burdens. In severe cases, metal bird deterrents can be added at the top line of modules to eliminate bird perches.

No matter what type of structure is used animals and unauthorised persons should be prevented from contact with array. Protect people from the sharp corners of the array. Since the PV module underside is the most vulnerable area of a PV module protect it from accidental contact or bird damage.

Two main categories of structures can be used: attached to the cold room and detached. Attached structures are used when the cold room structure is strong enough to support an array – and when the cold room is located in an unshaded site. When the cold room site is located where there is too much shading of the array then a detached solar array may be required to reach a location with acceptable shading losses (unshaded from 8AM to 4PM).

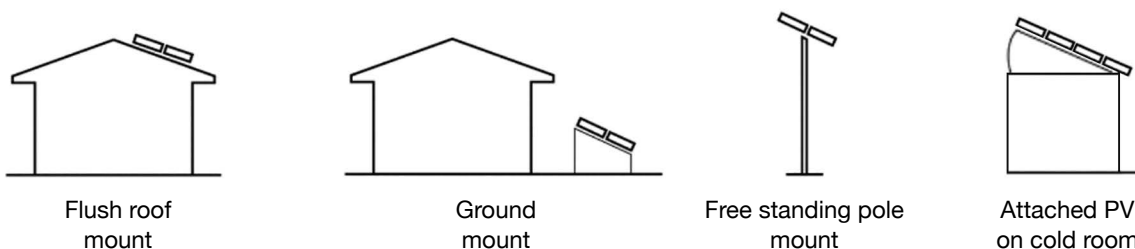

Figure 5.13

General PV array mounting options for cold rooms.

5.4.2.2 Arrays attached to the cold room

A metal structure can be bolted or welded to the cold room structure (Figure 5.14).

There are many advantages to this approach including:

- The cold room is used as the foundation for secure anchoring of the PV array.
- PV array shades the cold room, and this will reduce the solar heat gain on the cold room.
- If array extends over the roof, it may provide shade for produce and workers.
- Cable runs are shortest possible with less exposure.
- No underground or suspended cabling is required.
- Less ground space will be required than poles or ground mount options.

Disadvantages include:

- Increased wind load considerations.
- Danger of accidental contact with the sharp corners of the array.
- If array extends over the roof the vulnerable PV module underside is exposed.
- Increased access by unauthorised persons.

A solar array that must be located away from the cold room will always add cost and increase installation challenges. Often, the cheapest option for detached arrays is to mount them on other nearby buildings (Figure 5.15).



Figure 5.14
Attached solar array (*Ecofrost*).



Figure 5.15

Detached solar array (1.68 kWp) mounted flush to building roof (*photo: Sunny Day LLC*).

This approach will avoid foundation costs, can deter theft and unauthorised contact with people and most larger animals. Care must be taken to assure the detached building can safely support the solar array and the weight of workers during installation and maintenance. Cabling to the cold room will need to be buried or suspended.

Poles are also another option and there are advantages including height to avoid shading and theft deterrence. However, poles need to be sturdy and quality metal poles are not always readily available. Cost for a pole mount is usually more than attached or detached mounting when on nearby buildings. Cabling will need to be buried or suspended.

Ground mount structures are a third detached option (Figure 5.16). These require additional space, a properly designed foundation and many times fencing is needed to prevent direct contact with animals and unauthorised persons. Theft prevention must be considered in some locations. Cabling will need to be buried or suspended.



Figure 5.16

Detached PV array ground mounted near cooling equipment (*photo: Sunny Day LLC*).

5.4.2.3 Tracking mounts for arrays

Trackers move the PV array to follow the sun's path and increase array production more optimally. There are commercially available sun tracking mounts however these are not typically used for cold room applications due to added costs and complexity.

5.4.3 Batteries

5.4.3.1 Considerations for batteries

A battery is a chemical storage device for direct current (DC) electricity. Batteries add electrical, chemical, and physical hazards and logistical challenges. Furthermore, battery charge and discharge cause an efficiency loss of 10 to 20%. If the life of the cold room is 20 years, then most batteries will need to be replaced, most types of batteries will be replaced multiple times causing an increase in OPEX. Battery lifespan will vary with battery type. The longer warranties for cycling batteries (as opposed to standby batteries) are typically 10 years for industrial quality batteries, both Lithium-ion (Li) and Lead Acid (LA) and may be subject to numerous conditions that can void the warranty. Some batteries have no warranty.

The decision to include batteries must be carefully considered.

PV arrays generate DC electricity that can be stored in batteries that are necessary when electricity is required for times when the PV array is not generating electricity (nights and to sustain a supply of electricity through periods of low solar radiation). The length of time the battery can sustain electrical load operation with no recharge is called 'autonomy'. In solar power systems this must be at least the number of consecutive days of poor solar radiation (e.g. rain, cloudy weather).

Batteries are also used to supply a large amount of power to start compressor motors. A battery can instantly deliver more electricity than the PV array can generate instantly, and this large amount of electricity is useful to start motors on demand at any time day or night.

When multiple days of autonomy are to be supplied through battery storage batteries are the costliest component in a PV electricity system. They can also be the least reliable component. The battery system was found to be the most failure prone component of PV powered vaccine refrigerators (McCartney et al, 2013). Figure 5.17 shows an example of a rack of 12 V 220 Ah batteries. SDD refrigerators do not suffer this problem.



Figure 5.17

Rack of 12 V 220 Ah batteries for electrical energy storage (*Solarcool*).

Additional logistical challenges for quality battery installations (or for replacement) include limited availability in some countries therefore requiring importation. Importation adds fees, specialised handling requirements, delays and restrictions in some cases (e.g. prohibitions on both lithium battery based on capacity or fire hazard and prohibition when lead acid battery sulphuric acid electrolyte is shipped separately from an unfilled battery based on the potential diversion for production of cocaine).

Battery shipping introduces a variety of logistical challenges with additional sources of information given in 6.1.1. No smoking is allowed around batteries (e.g. lead acid batteries produce explosive hydrogen gas that can accumulate in enclosed spaces). The less a battery is handled, the less potential for damage. Batteries can be heavy and accidental drops can puncture the case allowing corrosive electrolytes to leak (e.g. flooded lead acid batteries). Punctures can cause fire hazards in some lithium batteries. Carefully inspect each delivery of batteries for shipping damage. One protection strategy involves ordering a sturdy wooden shipping crate to be used for transport. The weight of a crate of batteries may require a shipping truck with automatic lift capability or the crate will need to be opened and individual batteries hand carried. Plan for a safe and secure location for off loaded batteries. The location should be level and free of debris that could puncture the battery. Protect against unauthorised access to the battery to prevent theft and accidents (e.g. short circuits, physical damage to the battery and the person). Workers should have protective gear suitable for handling the battery type. Heavy weightlifting aids may be needed to safely move batteries.

If your business plans to import significant quantities of batteries, there are additional regulations that may mean your company needs a trained professional. When requiring small quantities of batteries, it is recommended to purchase from an in-country supplier that can deliver the battery to your location. Suppliers can be a company specialised in battery services or the solar equipment supplier. Installing, maintaining, and replacing batteries is a technical task that only qualified technicians should perform. For all the above reasons, it is recommended to minimise load requirement to reduce required battery capacity. To minimise loads it is recommended to use energy efficient equipment and utilise thermal energy storage whenever possible.

Autonomy: The capacity of the battery is mainly determined by the electrical load (i.e. Wh/day), if the load is considered critical, and the site-specific autonomy requirement. Location factors include ambient temperature of the battery storage compartment and the site-specific autonomy.

If continuous acceptable storage temperatures must be sustained, then an energy storage system must be sized to supply cooling for a predictable – or estimated – autonomy time frame with no external energy input. The autonomy time can be met entirely with thermal energy storage (TES) with no battery, or entirely battery with little or no TES or a hybrid solution relying on both.

In a PV system, the electrical energy supply autonomy time is site dependent on the number of consecutive days with little or no solar insolation (e.g. continuous rain where solar radiation reaching the PV array may be less than 5% of an average day). Data for measured consecutive days of poor solar conditions is not as readily available as data for monthly average solar insolation. Local knowledge should be considered but memories of weather events may not be accurate. Synthetic solar data will also attempt to estimate autonomy. One source for long-term measured autonomy data (and the month with lowest average daily solar radiation) for a selection of tropical location was developed for PV vaccine refrigeration systems (PQS, 2011).

With the PQS Autonomy Calculation Method, it was shown that for most tropical locations, a 3-day autonomy was sufficient as long as the PV array was oversized by an additional 25% over the calculated refrigerator load (kWh/day) plus all PV system losses (e.g. soiling, aging).

To calculate battery autonomy time, you first need to know what the target autonomy for the specific product being stored is. If it is critical to sustain acceptable storage temperatures throughout the full autonomy time that is based on local site needs, the TES autonomy time must be known (typically, TES will be used first, and when TES is depleted and the room temperature rises to cut in setpoint for mechanical cooling, the battery system will be used to begin electrical cooling recharge).

Example: Autonomy time is required to overcome rainy weather when flowers are harvested and stored briefly before being taken to market or exported. The load is considered critical because lost revenues not only reduce profits but jeopardise market requirements for regularly scheduled deliveries. The location is in a mountainous rural area near Bogota, Colombia, where the electrical grid is considered unreliable, and a PV-powered system is needed to cool a cold room with 1.5 days of thermal energy storage and a battery. The PV array that can be installed at this site will result in a 10% 'array oversize' factor of 1.1 (also called Array to Load Ratio, ALR). The PQS Autonomy Tool displays data for Bogota where a PV array with an array oversize of factor of 1.1 will then need 2.1 days of autonomy. The required battery electrical storage available for use will be at least 0.6 days (target autonomy = 2.1 days, TES = 1.5 days, battery = 0.6 days).

PV systems require rechargeable batteries that are capable of many charge/discharge cycles (called 'cycle life'). A 'cycle' is usually considered to be one day with a discharge and a recharge. Typically, these are 'deep cycle' batteries that can withstand long durations where a large percentage of capacity is discharged (50% or more). Shallow cycle batteries (e.g. vehicle batteries for starting, lighting and ignition) are not made for deep cycling and will fail quickly if used for deep cycling applications. Do not use vehicle starting batteries for a deep cycling application.

5.4.3.2 Battery types

Battery quality varies from industrial versions built to last 10 years or more to mid-range commercial versions with life of about 5 years (e.g. electric lift truck style) to light duty consumer versions with 1- to 3-year life (e.g. marine/recreational vehicle batteries). Life cycle comparisons for industrial and medium quality batteries are presented in Tables 5.3 and 5.4.

Lead Acid

The most common batteries used for PV applications have been lead acid, a family of rechargeable battery types that use positive and negative charged plates (electrodes) of lead alloy submerged in a conductive sulphuric acid electrolyte. In the family of lead acid batteries, there are both a flooded type where a liquid electrolyte is used and 'valve regulated' (VRLA, aka 'sealed', 'maintenance-free') type where the electrolyte is immobilised.

Flooded lead acid batteries are typically widely available and less expensive than a comparable quality VRLA. Flooded batteries require periodic maintenance (e.g. addition of distilled water and terminal connection corrosion removal). The liquid electrolyte is composed of sulphuric acid and water. The acid requires careful management to prevent damage to nearby electrical equipment and to avoid personal injury.

Valve regulated lead acid (VRLA) batteries are often called 'maintenance-free' because these cannot be opened and do not allow electrolyte addition. These can have either a gel electrolyte or an absorbed glass mat (AGM) holding the electrolyte in place. Some VRLA battery types cannot tolerate overcharging that can drive off the electrolyte and lead to immediate failure.

Lithium Ion

Lithium ion is a family of rechargeable batteries where lithium ions move between electrodes through an electrolyte. These batteries are widely used in rechargeable applications ranging from small electronics to portable hand tools to electric vehicles to grid utility large scale uses. They are also available for PV applications and experience with their use is increasing. These have the potential for longer life than lead acid, less maintenance and lighter weight. Life expectancy is expected to be 10 or more years. Several chemistries are in use with LFP (LiFePO₄), considered the safest, although there still remains a risk of fire from causes including improper charging and physical damage to the battery. LFP are presently more costly than lead acid batteries and, in some countries, availability may be limited. A battery management system (BMS) for safe charging and discharging is required. These BMS are an additional component and some BMS are built into the Li battery casing. However, if a built-in BMS fails that battery may be lost, while replacing the BMS logic board may be feasible and economic for larger batteries. Transport of Li batteries and importation can be restricted. For more information on all types of Li batteries see (Lighting Global, 2012).

Purchasing of spare deep cycling batteries (lead acid or LFP) is not recommended for a single cold room.

5.4.3.3 Battery rating

In a PV system with DC loads, the loads will usually determine the battery system voltage. For example, a 12 VDC refrigerator will require a nominal 12 VDC output from the battery.

The main ratings for batteries are nominal voltage and capacity. Lead acid batteries are sold as individual 2 V cells or an assembly of cells (e.g. 3 cells interconnected in series to form a 6 V battery, 6 cells in series for 12 V). Batteries can be grouped together to deliver higher system voltages (e.g. two 12 V, 200 Ah batteries connected in series for a 24 V, 200 Ah system) or higher capacity voltages (e.g. two 12 V, 200 AH batteries connected in parallel for a 12 V, 400 Ah system).

Battery capacity is typically specified in Ampere hours (Ah) (a capacity rating of batteries equal to one Ampere flow for one hour). The Ah capacity rating is typically reported for a range of discharge hours and will be presented as capacity over time. A battery with a rating of 200 Ah at C/20 would indicate that the battery can deliver 200 Ah over a 20-hour period (10 Ah per hour continuously for 20 hours). Some renewable energy battery manufacturers will specify an energy (kWh) discharg time (e.g. C/100) and this is helpful for longer autonomy times (over 4 days in this example).

The faster a battery discharges, the less energy is available. For example, a battery advertised as 12 V, 105 Ah will in fact only have a capacity of 85 Ah if quickly discharged over a 5-hour period (C/5). If the autonomy requirement is 4 days and a fully charged, new battery is discharged over 100 hours, then the capacity increases to 117 Ah (C/100). (Table 5.3).

Table 5.3

Battery capacity for four discharge rates.

Battery Type	Discharge Rate	Ah Capacity
12 Volt Deep Cycle Flooded LA	C/5 hours	85 Ah
	C/10	97 Ah
	C/20	105 Ah
	C/100	117 Ah

Battery life cycle will depend on the quality of battery and the depth of discharge (DOD) the battery will experience. The DOD is the amount of energy (%) removed from a battery compared to a fully charged battery. The deeper the discharge, the less life cycle a battery will provide. The designer/supplier will choose a maximum DOD when determining battery capacity. This is a trade-off between lower DOD with higher first cost versus a deeper DOD with lower first costs but earlier battery replacement time.

Some industrial lead acid batteries are made with tubular plates and have longer life cycle performance than flat plate batteries (typical of most low to medium quality batteries). See Tables 5.4 and 5.5 for cycle life comparison of battery types as well as cycle life vs. depth of discharge. Note that advertised cycle life is useful to compare options but often does not accurately predict actual battery life due to site specific variables in actual operating conditions, temperature and maintenance.

Table 5.4

Battery Cycles vs. Depth of Discharge – Medium quality battery.

Battery Type	Depth of Discharge (DOD)	Advertised Cycles
Deep Cycle, VRLA Flat plate construction	25%	1100
	50%	500
	80%	150

Table 5.5

Battery Cycles vs. Depth of Discharge – Industrial quality battery.

Battery Type	Depth of Discharge (DOD)	Advertised Cycles
Deep Cycle, flooded Tubular plate construction	20%	5000
	50%	2500
	80%	1500

Battery capacity and life cycle are both impacted by temperature. A lead acid battery stored at 0°C will have a reduced capacity compared to capacity at +20°C. However, if stored at higher temperatures life cycle will be reduced (and warranty may be reduced). This information will be found on specification sheets for higher quality batteries. Therefore, batteries should be protected from temperature extremes. For example, in the warm tropics, do not locate a battery in an uninsulated metal enclosure set in direct sunlight.

5.4.3.4 Battery charge regulator

The battery charge regulator (charge controller) is an essential component to prevent overcharging of the battery. Overcharging can increase maintenance and/or shorten battery life. Excessive discharge can also shorten battery life. In some types of batteries, improper charging can destroy the battery. Overcharging of Li batteries can result in overheating and fire.

Optionally, the charge regulator can also prevent excessive battery discharge. Typically, this feature will disconnect the DC load from the battery at a preset battery voltage ('low voltage disconnect'). The low voltage disconnect (LVD) can be used to manage and prioritise battery storage (as battery voltage falls) by first disconnecting nonessential loads while allowing essential loads to remain connected.

Other options available include temperature compensation, indicator lights, metering, and alarms.

Temperature compensation measures battery temperature and automatically adjusts the charging voltage to a more efficient setting.

Indicator lights are the simplest form of monitoring and usually track the battery voltage. Lights may indicate when the battery is charging or fully charged (e.g. green light), when the battery is becoming deeply discharged (e.g. yellow light) and when the battery is deeply discharged and/or disconnected (e.g. red light).

Voltage metering is strongly recommended to allow you to easily observe the operation of the PV power system and battery as well as estimate the battery state of charge. Ammeters indicate the current flow into the battery from the PV array and ammeters on the load side indicate current flowing out of the battery. Metering is a helpful tool for troubleshooting.

There are four types of battery charge regulators (shunt, series, pulse width modulation and maximum power point tracking). For cold rooms the two most common types of battery charge regulators are pulse width modulation (PWM) and maximum power point tracking (MPPT). Both adjust charging rates depending on the battery's state of charge (% charged) to allow charging closer to the battery's maximum capacity as well as monitor battery temperature to prevent overheating.

Depending on the selected battery, if maximum charging capacity is the main factor, it is better to consider a MPPT controller. An MPPT controller is also better suited for colder conditions where it produces up to 25% more charging than a PWM controller.

The control has an efficiency penalty. Maximum power point (MPPT) battery charge regulators are the most efficient by more closely matching the PV array output to the battery recharging requirements. The MPPT also allow a high voltage PV array to charge a lower voltage battery. Higher voltages result in lower current capacity allowing the electrical components to be smaller (e.g. smaller diameter wire and lower amperage fusing and circuit breakers). This is beneficial for detached PV arrays located a distance from the battery because an MPPT supports the array to be wired to a higher voltage that is more efficient for transferring electricity saving electrical component costs (e.g. the cables can be of smaller diameter with higher voltage). At the MPPT (near the battery) the higher array voltage is dropped to match the lower battery voltage.

Battery charge control cost is usually low, and it is advisable to purchase a spare and store it on-site.

The best practices for larger battery-based PV systems are an MPPT with optional LVD, temperature compensation and metering/monitoring features.

5.4.3.5 Battery subsystem and its enclosure or racking

The battery and battery charge regulator require a subsystem that includes cabling, overcurrent protection, protective enclosure, maintenance supplies and tools.

Cabling that interconnects multiple batteries will carry high amounts of current and typically have a large diameter. Battery to inverter cabling is also large and must be carefully sized to support the high DC current requirements of an inverter (e.g. where a large inverter is needed to deliver high wattage). Cabling connections must be secure to avoid losses and remain safe.

Overcurrent protection with a fuse or circuit breaker is usually placed near the battery. A battery can deliver very high current through a short circuit, and this must be prevented through overcurrent protection.

Batteries assembled on a sturdy rack may be necessary in areas with seismic activity or in mobile applications. In all cases, it is advisable to secure batteries in an enclosure or dedicated room.



Figure 5.18

Flooded lead acid battery in protective, ventilated enclosure 8 batteries, 6 VDC and 220 Ah each, wired in series for 48 VDC, 220 Ah (Sunny Day LLC).

During recharging, lead acid batteries produce flammable hydrogen gas that can be explosive when accumulated. A secure battery enclosure vented to the exterior is used to protect the battery from accidental short circuit as well as contain and expel corrosive and explosive gases that are produced while charging. The enclosure can be a simple box made of insect resistant wood, metal, masonry or acid resistant plastics (Figure 5.18). In some cases, the box needs to be insulated to protect the battery from ambient temperature extremes and solar radiation heat gain (when located outdoors). It is advisable to have a lock to prevent unauthorised access and deter theft.

5.4.4 Inverters

5.4.4.1 Inverter options

A 'battery inverter' (simply called an 'inverter' for this guide) converts direct current (DC) to alternating current (AC) electricity. An inverter is necessary in a battery-based electric system when electric load(s) require AC electricity. There are other types of inverters besides the 'battery inverter'. A grid interconnected 'solar inverter' (also called PV inverter) converts the variable direct current (DC) output of a photovoltaic (PV) solar panel into a grid synchronised alternating current (AC) that can be fed into a mains grid. In this guide, grid interconnected PV systems are not considered since these require a reliable grid in order to operate correctly and furthermore require approval from the grid operating authority to interconnect.

Inverters can be used either for grid/generator backup or as the essential, standalone power conditioning inverter from DC to AC, as used in standalone PV power systems. However, the efficiency of converting battery DC to AC ranges typically from 80% to 90%. When coupled with battery charge and discharge efficiency (e.g. typically 80% to 90%) the combined battery/inverter efficiency is now about 70% to 75%.

Inverters are categorised by the quality of the electricity they produce. 'Sine wave' inverters produce a waveform that is nearly identical to a reliable grid supply while 'square wave' inverters produce a lower quality waveform that does not operate some electrical loads. 'Modified sine wave' inverters fall between sine and square wave. Best practices indicate that sine wave inverters should be used for efficiency and correct operation of loads.

The inverter must have a power rating (watts) that will not only continuously operate the load but also have a short duration rating sufficient to start the load (e.g. overcome motor starting surge requirements). Larger AC load requirements often require inverters with higher DC input voltages from the battery (e.g. 48 VDC). Higher DC voltage systems are usually more energy efficient and can produce more power than a comparable lower voltage option (12 or 24 VDC). Higher voltage DC will also require smaller diameter cabling and lower amperage ratings for switches and overcurrent protection.

All inverters bring an efficiency loss, add cost, complexity and vulnerability to failure.

A built-in battery charger is an option offered with many inverters suitable for cold room applications. This allows a grid supply or a generator to be connected to provide AC for emergencies or for routine battery recharging with the optional, built in battery charger or a separate standalone battery charger.

Inverter warranties typically range from 1 to 5 years with some manufacturers offering 5, 10 or more extended warranties.

Other options are digital metering and integrated electrical hardware. An integrated inverter system can include wall mounting plate, battery charge control, metering, alarms, overcurrent protection, disconnect switches, bypass switch and remote control. Some panels are factory preassembled while others require on site assembly (Figure 5.19).

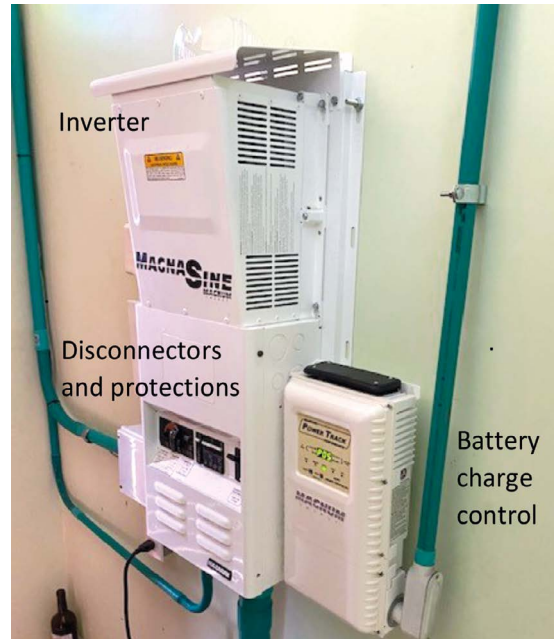

Figure 5.19

Battery inverter mounted to an integrated electrical hardware panel with PV battery charge control, disconnects, overcurrent protection (powered by grid or generator) (photo: Sunny Day LLC).

5.4.4.2 Sizing an inverter

Sizing an inverter requires load data including instant consumption (all connected loads that can operate simultaneously) and electrical input/output requirements (battery input VDC and inverter out VAC and frequency). A vapour compression refrigerated cold room load will include motors (e.g. compressor, air mover). Motors will need starting power (called lock rotor amps. LRA) that is usually greater than running power. Designers will need to know both starting and running power requirements.

Example: The refrigeration design calls for a single ½ horsepower compressor motor that runs on 230 VAC, 50 Hz input and is specified as requiring 600 W (running) with a starting requirement (i.e. locked rotor amps) specification of 6.8 A (1564 W). The solar power system was planned to be a nominal 12 VDC system with battery intended to start and run this compressor.

From a review of commercially available battery inverter specifications, it can be confirmed that there is a wide selection of inverters requiring input from a 12 VDC (nominal) battery with sine wave output of 230 VAC, 50 Hz. However, some 600 W nominal inverters offer a short-term surge capacity of just 1000 W and these inverters would not start the compressor. Similar quality 1000 W nominal inverters are also widely available, and these will add a margin of advisable oversizing for load increases in the future. Some 1000 W inverters can provide surge power of 2000 W (or more). Choose an inverter that will match the connected load electrical requirements and has adequate surge capacity to start all connected loads.

5.4.4.3 Inverter warranties

Inverter warranties range from months to years. If the inverter has field repairable parts (e.g. cooling fan, key electronics) some manufacturers will sell them as spare parts. It is advisable to purchase spare parts and keep them on site. Otherwise, inverters are likely to require replacement during the lifespan of the cold room, and this additional cost needs to be accounted for.

5.4.4.4 Key questions when specifying an inverter

Questions to pose to the supplier of the inverter are these – see above sections for details:

- Which wave form is supplied by the inverter (sine wave is best; square wave is poor)
- Is the inverter guaranteed to simultaneously operate all cold room loads
- Inverter power ratings (W – continuous, W – short term)
- The surge capacity to start your compressor(s)
- How multiple compressors will be started (in cold rooms with multiple cooling units)
- What optional features are included
- Warranty and servicing provisions
- Maintenance requirements.

5.5 Thermal energy storage (TES) options

This guide focuses on how to sustain acceptable storage temperatures when the primary electric power supply is interrupted. The time when this supply is interrupted defines the autonomy time target. Energy storage is the solution for bridging this time gap. For example, a cold room installed where limited grid electricity is routinely supplied for 6 hours per day would then require an autonomy of at least 18 hours, assuming no sustained power outages. A PV powered cold room installed at a site where 3-day rainstorms are known to occur thereby reducing PV power input almost entirely would need a 3-day autonomy to sustain acceptable storage temperatures. In both examples the energy storage could be entirely by passive means with thermal energy storage (TES) or entirely active with electricity stored in a battery or a hybrid combination of both. With a hybrid, the best practice is to design the energy storage to first utilise TES, and when temperatures rise to a predetermined cut in setpoint the battery electricity will be connected to operate the active cooling equipment. If the combined autonomy of the TES and battery equal or exceed the target autonomy time, then acceptable storage temperatures will be sustained.

5.5.1 Current trends in TES

Thermal Energy Storage (TES) bridges the time gap between energy requirement and energy use. A thermal storage application may involve an autonomy time of few hours, to daily or longer storage cycles depending on the system design requirements.

One can store energy in sensible storage formats like large water tanks and thick walls, etc. However, large volume, as well as large temperature difference requirements can restrict the application of sensible TES options and therefore most of the TES applications are based on using the latent heat capacity during the phase change process. For this purpose, water or phase change materials (PCM) can be used, depending on which temperature the thermal storage should have.

Water has many obvious advantages (widely available, low cost, low corrosiveness, non-toxic, used as both a primary or secondary storage fluid with options based on properties of water and/or water-ice), but when its freezing temperature (0°C) is unfitting for the purpose, PCMs are used.

Following the definition by WHO Performance, Quality and Process, a PCM is *a material, other than water, which changes its state between solid and liquid or changes between two different solid crystallisation states over a defined temperature range, absorbing or releasing heat during the phase change. This process is reversible and can be useful for thermal control in cold chain devices and products.* In other terms, PCMs can be described as mixtures of chemicals having freezing and melting points above or below the water freezing temperature of 0°C (Burton and Ure, 1997). Various kinds of PCMs are available, among which:

- Eutectics tend to be solutions of salts dissolved in water that have a phase change temperature below 0°C .
- Salt hydrates are specific salts that are able to incorporate water of crystallisation during their freezing process and tend to change phase above 0°C .
- Organic materials used as PCMs tend to be polymers with long-chain molecules composed primarily of carbon and hydrogen. They tend to exhibit high orders of crystallinity when freezing and change phase above or below 0°C . Examples of materials used as positive temperature organic PCMs include alcohols, waxes, oils, fatty acids and polyglycols.
- Solid-Solid PCMs that undergo a solid/solid phase transition with the associated absorption and release of large amounts of heat. These materials change their crystalline structure from one lattice configuration to another at a fixed and well-defined temperature, and the transformation can involve latent heats comparable to the most effective solid/liquid PCMs.
- Molten Salts are naturally solid salt materials which turn liquid when they are heated above their transition temperatures and act as a PCM energy storage material.

PCMs are therefore ideal products for thermal management solutions thanks to their ability to store and release thermal energy in a small temperature range. They are available in different shapes and containers, as pouches, tanks to hang at walls (figure 5.20), tubes to hang at ceiling (5.21).

A majority of the current cold stores utilise conventional direct expansion refrigeration circulation air within the cold-room and therefore any thermal energy storage component must be added within the cold room and charged by the cooler air circulation. More details on the installation of TES in the cold rooms are given in Subsection 4.11.4.



Figure 5.20

Packed eutectic solution to be hung at walls or placed within produce in a cold room (PCM products Ltd).



Figure 5.21

Packed eutectic solution in tubes hung at the ceiling of a cold room (Freshbox).

5.5.2 Thermal Energy Storage compared with electrical energy storage

When an energy storage system is required, either for off-grid applications, or for limited grid or to take advantage of off-peak tariffs in reliable grids, the choice must be made between thermal storage, electrical storage (i.e. batteries) or hybrid systems with both. Designers might have to find the balance between electrical versus thermal energy storage for both economical and overall aspects of their designs so as to suit the application requirements (e.g. size, weight, upfront investment cost, life cycle cost, environmental impact).

The quantity of energy to store is almost proportional to the volume of the cold room, with a slight advantage for higher volumes due to the lower impact of heat loads through the walls.

Thermal storage often implies a special design for the components inside the cold room, except when a secondary fluid is used to provide the cooling power. For optimum performance, the TES material should be selected so that the set point at the evaporator is 2°C or 3°C lower than the phase change temperature of the TES unit filling (freezing/melting).

The refrigeration unit has to be oversized creating spare cooling capacity during daytime in order to charge the thermal energy storage units. However, for off-grid applications larger refrigeration machinery also means larger number of solar PV modules are required to run the oversized system. As a rule of thumb, the cooling capacity of compressors can be estimated as the cooling energy (kWh) required by the cold room over 24 hours divided by the number of running hours, i.e. the number of hours when the grid or electric power is available for an off-grid system with TES.

Electrical storage allows cooling power to be supplied to the refrigerating unit whenever the primary electric supply (grid or solar power) is unavailable. With electrical storage the cooling system has not to be oversized and continues to operate normally with uninterrupted air circulation, air supply temperature and cooling power.

However, batteries are generally costly over their life cycle as they need to be replaced frequently over the cold storage lifetime. Lower cost 'flooded' lead acid batteries also require frequent maintenance to replenish liquid electrolyte and remove corrosion. The number of PV modules has to be increased in off-grid applications, to allow enough spare capacity to charge the batteries for autonomy time operation and overcome power system efficiency losses.

5.5.3 Example sizing a system with TES

An example of design for an off-grid system in a typical 20 ft container application, with either electrical or thermal storage is reported in Table 5.6. The heat loads are estimated, considering 8-hour recharge time for the TES system. Then the refrigerating unit, the electrical or thermal storage and the PV modules are sized.

The assumptions for this example are:

- Sufficient solar power to run the refrigerating system and recharge batteries is available 8 hours a day; if cloudy days are not considered and the autonomy has to be 16 hours.
- Cooler fans run 50 % of the running time of the refrigerating unit, to account for on/off cycling.
- Lights are switched on 3 hours/day.
- TES latent heat storage capacity is 90 kWh/m³ (similar to pure water).
- TES density (envelope included) is 1250 kg/m³.
- Inverter efficiency is 0.85.
- Charge/discharge efficiency is 0.85 for both batteries and TES.

The refrigerating unit cooling capacity is estimated on the basis of 24 h running time for the case with electrical storage, 8 h running time for the TES. Table 5.6 shows the refrigerating unit for the TES case has more than 2 times capacity compared to the other, as expected (it has to perform both cooling and storage recharge simultaneously). An average value of the COP is assumed (COP = 2), thus allowing to estimate the electrical energy required for both systems and at both operating conditions. The number of PV modules can be estimated, based on the energy required for recharge and operation for the electric storage, or just operation for the TES case. Finally, the number of batteries and the amount of TES material is calculated based on the energy stored.

The outcomes from Table 5.6 show that the solution with TES requires a lower number of PV modules (8 instead of 14 required for electric storage). This is due the inefficiency of inverters and to the lower amount of energy required by cooler fans, which are assumed to operate 8 h/day in the TES mode instead of 20. This outcome also underlines the need for a thorough evaluation of the cooling load (Part 4) and consequently of the cooling capacity required. An underestimation of the cooling load leads to a poor sizing of all the components and dramatically increases the risk of making the system ineffective.

In the example, 12 V batteries have been considered, for their wide availability and low cost. A 48 V solution could be far better if available and affordable, to significantly reduce current values and cable losses.

Weight of storage means is also estimated. This weight issue may not be a major issue for stationary cold storage applications, but batteries are usually placed on the ground, while TES plates can be hanged to the ceiling or walls of the cold room. In this case, TES weight has to be considered when sizing the cold room structure.

The overall long-term cost might be therefore, together with reliability and environmental issues for disposal, one of the main drivers for finding the balance between battery vs thermal energy storage for static solar-powered cold chain operation. Prices have to be investigated thoroughly. It should be reminded that the size of both the refrigerating unit and the PV modules changes with the type of storage, and that the electrical storage has some running costs due to battery and inverter maintenance and replacement.

This example could also be used as a guideline for sizing batteries or TES for a site with limited grid, when some autonomy is requested but sufficient PV modules cannot be installed.

Table 5.6

Example of sizing of components for a 20 ft container cold room, off-grid with energy storage.

	Chilled storage		
Room temperature	2		°C
Outdoor temperature	35		°C
Refrigerating unit running time	24	8	h/day
Solar energy availability time (on PV time)	8		h/day
Autonomy (off-grid hours)	16		h
Length x Width x Height	2.30 x 6.00 x 2.30		m
Room walls surface area	51.98		m ²
Room floor surface area	13.8		m ²
Insulation material	Polyurethane		
Thickness	100		mm
Floor insulation	0		mm
U-value insulation panel	0.21		W/m ² K
Cooler fans	70 - 12	70 - 4	W - h/day
Illumination	25 - 3		W - h/day
Products	Vegetables		
Heat loads			
Transmission losses	581	581	W
Ventilation losses	464	464	W
Other heat sources	915	355	W
Respiration	24	24	W
Total Heat loads	1984	1424	W
	OFF-GRID Electric storage	OFF-GRID TES	
Refrigeration Unit Cooling Capacity (24h/24h)	2.0		kW
Refrigeration Unit Cooling Capacity (8h/24h)		4.3	kW
COP	2.0		
Refrigerating Unit Electrical Power	0.99	2.14	kW
Inverter efficiency	0.85	0.85	
Refrigerating unit + Inverter Electrical Power	1.17	2.51	
Daily Electrical Energy required at off-grid hours	18.7	0.0	kWh _e /day
Charge and discharge efficiency	0.85		
Daily Electrical Energy to batteries for off-grid hours	22.0	0.0	
Daily Electrical Energy required at on-PV hours	9.3	20.1	kWh _e /day
Daily Electrical Energy required	50.8	20.1	kWh _e /day
ELECTRICAL ENERGY STORAGE			
Battery capacity @ 12 VDC to supply at off-gr	1831		Ah
Daily Electrical Energy (Battery Charging if any + Refrigeration Machinery Operation)	31.3	20.1	kWh _e /day
PV module electric power	300		W
Number of 300 W standard PV modules	14		
Number of 12 VDC-200 Ah Batteries	10		
Batteries Weight	650		kg
THERMAL ENERGY STORAGE			
TES Cooling autonomy requirement		16.00	h
TES Cooling load required at off-grid hours		31.74	kWh
Charge and discharge efficiency		0.85	
TES Volume		0.41	m ³
TES Weight		519	kg
Number of 300 W standard PV modules		8	

5.6 PV system safety

A PV electric power system, like a mains electricity system, has several safety hazards. The addition of batteries and cleaning requirements of solar array bring very different hazards than maintenance required with a grid electricity connection. These hazards can be safely managed and prevented through user training and an electrical system with proper design, installation, operation and maintenance.

Local, national and international electrical codes and standards have been developed to address safety issues. Always follow local requirements and it is strongly advised that the designer/equipment supplier comply with international norms and standards. One source for a compilation of solar energy related safety topics is the 2021 International Solar Energy Provisions, International Code Council¹³.

5.6.1 Electrical hazards

The PV array is an electrical generator and produces a voltage even in low light levels. Arcing, short circuits and shock are potential hazards that can be lethal, even with direct current (DC) solar power systems. PV voltages range from 12 VDC for smaller systems that many persons have some familiarity with to larger systems like those that may be necessary to power a cold room. The larger systems need higher voltages (hundreds of volts) where the current flow becomes so strong that a person caught in a short circuit can be killed. Shock happens when electric current flows through the human body. Both burns and muscle contractions can occur. Muscle contractions can prevent a person from breaking free from the electric current which can impact the heart, possibly causing death. Shocks and burns can frighten people and secondarily cause a person to jump aside or fall from a ladder causing physical injuries.

Arcing is when electricity travels through air and arcing can cause fires, damage equipment or cause physical injuries. Disconnecting a live circuit by pulling the plug or disconnecting a wire can cause damage to equipment and physical danger.

Short circuits occur when there is an unintended contact of components that results in a diversion of electricity. This can cause arcing, burns, fires, explosive reactions and physical injuries. Some of the ways PV power systems have had short circuits include exposed battery terminals that are accidentally shorted by falling metal tools or moist skin contact between negative and positive connections, exposed cabling allowing rodents to chew through wiring insulation or improper wiring techniques.

5.6.2 Physical hazards

Like any work area there are potential personal 'trip and fall' hazards, especially during installation and maintenance. Batteries, inverters and large solar modules can be heavier than one person can safely manage during installation or replacement, exposing them to muscle strains that can lead to equipment damage and personal injury. PV module frames are usually metal with sharp corners that can cause deep cuts. Locate the sharp corners above head level or where people will not accidentally encounter them. Protective headgear (e.g. construction hard hat) is recommended when working on or near a PV array where accidental head contact is possible.

¹³ <https://www.iccsafe.org/>

Falling from – or through – roofs is known to occur for any roof workers. Installation and maintenance cleaning of solar arrays may involve climbing on ladders putting persons at risk of falls. Roofing strength must be adequate to support the weight of workers required to access the roof. Designers must plan for PV array access for cleaning and other post installation work. Insist on safety harnesses for roof work.

Outdoor equipment is known to provide shelter for venomous snakes, biting insects and rodents.

Wind can damage or even destroy a solar array if not designed for expected conditions or when not installed securely.

5.6.3 Chemical hazards

Thermal energy storage (TES) and batteries present potential chemical hazards.

Batteries can be corrosive and explosive. The most common batteries are lead acid and both the lead and the acid are dangerous when mishandled. Acid is corrosive and flooded (aka 'wet') lead acid batteries can burn eyes, skin and clothing as well as damage electrical components. When charging a flooded lead acid battery, a fine mist is emitted that has corrosive acid and explosive hydrogen gas. Lead is toxic and must be formally recycled when it is replaced. Deaths have been documented to occur to both humans and animals involved in -or living near – informal lead recycling¹⁴. Lithium batteries have fire hazard risks due to improper charging/discharging, accidental impacts, puncture and short circuiting. If Lithium batteries are considered, carefully review the fire safety requirements of the site and seek professional advice on associated risks. Guidance is published by many sources including the Fire Protection Research Foundation¹⁵. Some cities have strict regulations on how and where Li batteries can be safely recharged, stored, and used.

Thermal energy storage can be made of water but other 'phase change materials (PCM)' can be composed of corrosive chemicals. Corrosive PCM can cause equipment damage as well as physical harm. Proper packaging of PCM is essential to prevent leakage.

All batteries will eventually fail, and end of life management instructions are necessary for all battery types.

5.6.4 Hazard avoidance

Avoid these hazards by ensuring qualified persons design, install and maintain the equipment. Train users to understand system hazards, how to avoid them and to immediately report any potential hazardous situations.

The electrical design must follow electrical and fire codes that will require both obvious and hidden protections (like fusing or circuit breakers to interrupting current flow during a short circuit, preventing damage to wire and equipment that can lead to fire). While uncommon, PV modules and lithium batteries can be fire hazards.

Battery protection is best when built-in to protect from unauthorised access, accidental short circuit and containment of corrosion and venting of explosive gas. Require that the PV system include proper maintenance tools (e.g. telescoping handles for solar array cleaning tools) and personal protective equipment (e.g. eye, hands and clothing protection for battery maintenance).

¹⁴ https://www.who.int/emergencies/disease-outbreak-news/item/2008_06_23-en

¹⁵ R. Thomas Long Jr and Andrew Blum, *Lithium ion batteries hazard and use assessment—Phases I, II and III*, Fire Protection Research Foundation report, July 2011 / April 2013 and November 2016. Available from: <https://www.nfpa.org/News-and-Research/Data-research-and-tools/Hazardous-Materials/Lithium-ion-batteries-hazard-and-use-assessment>

Use only trained, qualified installers who will not work on live electrical circuits. Do not allow unauthorised persons to work on the electrical system or come in contact with live electrical parts. Post warning signs to alert all users and other persons of hazards.

Ensure users are aware of the hazards, know how to contact qualified electrical technicians for support and provide a fully equipped first aid kit based on the system design. Users should assume all electrical connections are live including any fallen electric cabling. Protect – or warn of – sharp corners of solar arrays. Provide safe and secure access for maintenance of PV arrays and batteries. Be always observant of animal hazards and especially under solar arrays and when opening electrical enclosures.

At the end of battery life, recover the battery and deliver it to a commercial recycler.

5.7 References

Burton G., Ure Z. (1997). Eutectic Thermal Energy Storage Systems. CIBSE National Conference, Volume II, Alexandra Palace, Oct. 1997, UK.

Efficiency for Access. (2023). Life Cycle Greenhouse Gas Emissions Assessment of Off- and Weak-Grid Refrigeration Technologies.

Available at: <https://efficiencyforaccess.org/publications/life-cycle-greenhouse-gas-emissions-assessment-of-off-and-weak-grid-refrigeration-technologies>

IEEE 1562 (2021). Recommended Practice for Sizing of Stand-Alone Photovoltaic (PV) Systems.

IRENA (2022). International Renewable Energy Agency, Renewable Power Generation Costs in 2021, Abu Dhabi, UAE.

Lighting Global Technical Note, Lithium-Ion Battery Overview (2012).

Available at: <https://www.lightingglobal.org/resource/lithium-ion-battery-overview>

McCarney S., et al, (2013). Using solar-powered refrigeration for vaccine storage where other sources of reliable electricity are inadequate or costly. *Vaccine*. 2013;31(51):6050 (<http://www.ncbi.nlm.nih.gov/pubmed/23933340>).

PAHO (2016). Pan American Health Organization internal training module FGL/IM-PAHO 2016).

PQS (2011). Solar Autonomy Calculation Method

Available at: <https://extranet.who.int/pqweb/sites/default/files/documents/Solar%20autonomy%20guideline.pdf>

UNDP (2018). Solar For Health - Strategy Overview and Case Studies

Available at <https://www.medbox.org/document/solar-for-health-strategy-overview-and-case-studies#GO>

WHO/UNICEF (2015). Introducing Solar-Powered Vaccine Refrigerator and Freezer Systems, Geneva, Switzerland

Available at https://apps.who.int/iris/bitstream/handle/10665/195778/9789241509862_eng.pdf?sequence=1



Installation and commissioning

6.

Installation and commissioning

6.1 Planning for installation

This guide assumes that one or more specialist suppliers and contractors will be hired to manage the tasks of design, shipping to site and installation. Appointing a single contractor with responsibility for the whole process should reduce the chance of communication and logistical problems but may not be an option for many locations or supply situations. Find out how much experience your contractor has with this type of equipment. Use the questions and discussion points given here to help develop a good understanding between buyer/manager and experts/contractors. Not all points are applicable in every case. The advice in this section is not supposed to turn the reader into an expert but will help them to keep an eye on progress and ensure the final installation is done well.

A guide to good practice for installation of walk-in cold rooms is given in Annex D of European Standard EN 16855 Part 2¹.

Prior to installation, review all safety considerations. Section 4.12 includes safety considerations for the cold room and the staff and Section 5.6 provides safety considerations for the electrical power system including specific solar power system aspects.

Make sure that the implementation site is ready when the equipment is delivered, and especially that a safe and suitable place is ready to receive, check and store it.

6.1.1 Considerations for import and shipping of equipment to the country

Lots can go wrong in the process of shipping and importing equipment and this applies also to emerging economies. Problems with paperwork can lead to extra costs, months of extended delivery time and the need for multiple workarounds: so, put a lot of effort into planning the shipping and get expert advice. Knowledge to ensure smooth processing cannot be gained only by reading schedules of requirements, websites and forms. There is often no real alternative to having a shipping agent who knows the reality of how shipping bureaucracy works, right now, in that region. Points to discuss with a shipping agent include:

1. Review shipping recommendations given in these sources:

- For shipping of batteries, see advice in Subsection 5.4.3 of this guide, in particular Subsection 5.4.3.1.
- For shipping of refrigerants see also advice in Section 4.8 of this guide, in particular on shipping flammable refrigerants.
- The Efficiency for Access 'Guide to Shipping Appliances' includes a section on the implications of shipping refrigerating equipment by air on page 12².

¹ EN 16855-2 Walk-in cold rooms - Definition, thermal insulation performance and test methods, Part 2: Customized cold rooms, Annex D Guide on Installation. The Annex is around 16 pages and covers tools, installation of panels, floor, doors and windows, types of joints, vapour sealing, installing pressure relief valves, maintenance, cleaning and more.

² Available from: <https://efficiencyforaccess.org/publications/practical-guidelines-for-shipping-off-grid-appliances>

- The East African Regional Handbook on Solar Taxation (2022)³ includes introductory guidance on how tax, tariff and import duties apply to solar equipment, a list of the most common exempted, non-exempted and zero-rated solar products and certification options such as pre-export verification of conformity (PVoC). Whilst tailored for the East African Community, the explanations and glossary will help newcomers get acquainted with many issues around importing solar equipment anywhere.
- The Efficiency for Access generic guide on field testing also includes guidance on shipping equipment⁴.
- If shipping rules information is regularly required for different countries, consider one of the subscription or membership-based consultancy resources for monitoring import formalities, tariffs and more (example is given in the box below).
- If shipping of goods subject to safety and other restrictions (such as batteries) is a regular business need, then it may be worth getting one or more staff members trained and qualified to specify and contract this work. Organisations such as industry associations and commercial companies⁵ offer courses for road, rail, domestic and maritime transport of such goods. Prices for courses in Europe vary between €800 and €1,200 for three to five-day courses, plus examination fees and learning materials. Such qualifications are valid for a limited time and must be renewed regularly.

ORGANISATIONS THAT OFFER INFORMATION ON IMPORT RULES INCLUDE:

A subscription-based information source on import formalities, tariffs and more for over 160 countries is Mendel Verlag, based in Germany and offering also English language services. See <https://www.mendel-verlag.de/en/products/webportals/>. Their MendelOnline tool is a route to search for requirements by country and by product keywords and product codes (see <https://mendel-online.eu/mo/Start/Start.do>).

The German Industry Association IHK also offers access to the 'K and M' export reference book, which is available in printed, CD and online versions, also from Mendel Verlag. See <https://www.ihk.de/hamburg/produktmarken/beratung-service/international/export/exportvorschriften/einfuhrbestimmungen-konsulats-mustervorschriften-1167178>

2. Find out the relevant Harmonised System (HS) Codes for the main systems or components being shipped. The HS codes are important to identify equipment for import duties and tariffs, and to benefit from any exemptions that might apply to solar or energy related equipment.
3. Verify the overall dimensions and weights of the packs of components to ensure safe shipping is arranged.
4. Determine how the equipment will be protected from damage in transport. Insulated panels are bulky and easily damaged – if the skin is punctured, then moisture can get into the insulation and over time it will cause failure of the board; similarly, if any joint, mating edge or cam lock mechanism is damaged, it cannot make a good seal. If it is opened for inspection, make it as easy as possible for it to be re-packaged and sealed securely, including a packing list.

³ Available from: <https://sun-connect.org/documents>

⁴ *Field Testing of Appliances Suitable for Off- and Weak-Grid Use, Generic guidance on appliance performance monitoring in the field, January 2022, pages 30 & 31. Available from: <https://efficiencyforaccess.org/publications/field-testing-of-appliances-suitable-for-off-and-weak-grid-use>*

⁵ *Examples without implied endorsement include IHK, TÜV and DEKRA (<https://www.dekra.com/en/transport-and-logistics-training/>).*

5. Obtain a full list of which tariffs and duties must be paid from authorities or your shipping agent. Find out what exemptions or reductions on import duty or tariffs are available for equipment of this type. (See notes on shipping above and especially the East African Regional Handbook on Solar Taxation.)
6. Determine what paperwork must accompany the goods, including descriptions, declarations of product type and category for safety and taxes and declarations of conformity with local regulations.
7. Check whether self-certification of compliance with requirements is adequate, or if third party certification is required for some or all aspects.
8. Check whether pre-registration of imminent arrival is required (or advisable) before the goods reach the border. This can save time and trouble later.
9. Find out what the stages of approval of the shipment are and which bodies do that.
10. Check whose contact details must be given on the paperwork (perhaps named individuals) and make sure that they will be immediately accessible. Ensure as well that the contact has the language and technical skills to deal quickly with queries.
11. Decide who will manage the final clearance process and pick-up from the port of arrival and make sure they are fully briefed on the procedure.
12. Transportation to site should be done quickly after final clearance to avoid any costs from storage of the cargo at the port of arrival. Plan the onward journey in advance, including estimation of arrival date and time at the installation site – see next Subsection 6.1.2.
13. If storage at the port is required, make sure that the storage area is adequate to protect the equipment. Shipping containers left in the sun for extended periods get hot and can result in heat damage to components such as lead acid batteries and some mechanical controls.

6.1.2 Transportation to site

The risk of damage to equipment is greatest in the 'last mile', where roads are worst and transport options are limited. This is where effort on packaging and finding a reliable local transport company pays off. Smart packaging might also help (see anecdote below).

The first tasks on arrival are checking the number of packages against the shipping list and looking for transportation damage – note and photograph damage, and immediately notify the supplier if items inside seem to have been affected. When a safe and suitable space is available, carefully open the packages and check that contents match the parts lists and are undamaged, including installation accessories.

Any puncture of panel skins and any damage to joint faces must be repaired or moisture will get into the structure.

ANECDOTE: Packaging gives scope for creativity

Dutch electric bicycle company Vanmoof achieved an 80% cut in shipping damage when it used motifs on its boxes that give the impression that the box contains a large screen TV, rather than a flat-folded bicycle⁶. No false declarations were made – just a large motif on the box that looks like the outline of a TV (it also includes a bicycle motif).

⁶ See <https://www.artofit.org/2021/04/04/dutch-bike-company-puts-tv-on-packaging-reduces-shipping-damage-80>

6.1.3 Site location and floor preparation

Choosing a suitable cold room location is discussed in Sections 3.5 and 4.11. Review and define the location and its facilities. The design and many details about the insulated enclosure are explained in Section 4.6. Part 5 on power systems of this guide details a site requirements worksheet (Subsection 5.2.5).

Before installation begins, check the chosen site for these points:

- Once satisfied the intended location is the best, mark out the perimeter of the cold room (i.e. on the prepared floor if sheltered or on the undeveloped site if standalone). Agree on the location with the whole project team.
- Ensure that the floor area is flat and level, ideally to within 5 mm. Insulation boards will have to be cut and adjusted to fit if the floor is uneven; it may also affect door opening and door adjustment.
- The floor should be hard, smooth and dry. Soft materials such as sand, gravel or soft earth will lead to movement of the structure, opening joints between panels causing water vapour ingress, heat leaks and eventually even failure of the cold room.
- If a concrete floor is laid for the store, the site must be dry before cooling begins or ice formation could break up the concrete, especially if it is uninsulated (for a frozen store) – drying to full strength can take up to a month, depending on temperature conditions.
- For aligning and jointing insulation panels, especially if a recessed (dug out) floor area is being used, allow clear adjustment space of 200 mm beyond any wall with a door, and at least 50 mm in all other directions.
- Leave a clearance of at least 100 mm between the walls of adjacent cold rooms so that air can circulate and dry any condensation. Otherwise, moisture will degrade materials and cause future problems. If separate cold rooms are needed close to one another, it is better to use a partition wall inside a larger insulated enclosure.
- Discuss how the internal floor surface is prepared to prevent damage in use, to avoid users slipping if it gets wet and so that it is easy to keep the floor clean. If the cold room is to be used for meat or fish, ask if it will have a special sealant coating to prevent fluids from stored produce seeping into flooring joints and surfaces, as this is a health hazard and damages the structure.
- As far as practicable, complete civil works of preparing the site including foundations and any PV array mounting that is detached from the cold room before delivery of the cold room equipment. This leaves more space for preparation and reduces risk of accidental damage to fragile components such as insulated panels, condensers and evaporators.

Note that there are several special requirements for floors under freezer stores, but this guide addresses only chilled cold rooms.



Figure 6.1

Cold room on a concrete floor, with foundations for the PV array mounting (Coolcrop).

6.1.4 Points to discuss with the installation team

Below are listed details of the installation process that are worth discussing with your contractor to check that all is in hand:

1. Discuss the list of tools, equipment and consumables needed to construct and commission the cold room. As well as the basic toolset, do not forget a fully stocked first aid kit and any special tools for closing cam-lock joints on prefabricated rooms; gloves for handling panels; sealant guns and sealant including for vapour sealing after any holes are made through panels for wiring; a 4 ft carpenter's level (bubble level) to ensure flooring, panel edges etc. are horizontal or vertical; saws; a riveter; twine for tracing the cold room perimeter on the ground; handheld temperature measurement tools (ideally a handheld thermal detector that can measure the surface temperature at a distance of a couple of metres, for checking insulation, joints and thermal bridges – these can be bought for less than USD100).
2. Carefully consider each construction step and the items needed for each step. Missing items will halt progress and could take weeks to get to the site, with workarounds likely to degrade viability of the store.
3. If the design uses flat-pack cold room insulated panels, ensure that any protective film is peeled back from the panel edges before moisture seals are made and decide when full removal of the protective film should happen.
4. Confirm how many people will be needed to handle the cold room panels to get them into position for locking and sealing – as well as PV components if used (e.g. modules, batteries, inverters). These components can be large, hard to handle and easily damaged, especially panels and PV modules in breezy conditions (Figure 6.2).



Figure 6.2

Correct handling of panels to prevent damage requires at least two people (Sonja Mettenleiter, SelfChill).

5. Make sure that everyone in the team understands that panel skin punctures must be fixed – this can be done quickly and effectively during construction. Unrepaired holes or gaps will cause moisture leaks that degrade performance and even cause the structure to fail months or years later (see Subsection 4.6.4).
6. Check that the technicians have free access to all sides and corners of the walls to fully close the camlocks or to make the panel joints where necessary. Once all the panels have been secured together, the camlock tool access ports should be sealed with caps/inserts.

7. Discuss how moisture sealing will be done, e.g. types and sizes of joint sealants, how a seal is achieved to the floor, around windows and doors; for cables and pipes that pass through the panels – circular plates are usually used that are sealed to the panel faces (see Subsection 4.6.2).
8. Ask what checks are planned regarding air leakage and moisture sealing efficiency. For example, to feel and listen for air movement along joints and seals, especially as the door is closed and opened. If contractors know this will be checked, they are more likely to ensure it is done properly (Figure 6.3).



Figure 6.3

Air leakage and vapour sealing of the cold room panels using a caulking gun, to prevent hot and humid air infiltration (Sonja Mettenleiter, SelfChill).

9. Opposite walls should be parallel so that joints and doors are easy to seal and so roof and racking will fit properly. This can be verified by checking that the corner-to-corner diagonals are equal to within one percent or less.
10. Holes in insulation should be cut no larger than necessary, with no voids or gaps created. Fill any voids with a suitable insulating filler before covering and sealing. Good practice is to bond a rigid reinforcing disc around the hole; for pipes: to pass the pipe complete with its insulation jacket through the panel; for electrical wiring to bond and seal a sleeve made of fireproof material through the panel, then pass the wire through the sleeve, also sealing the wire within the sleeve⁷. This avoids heat leaks and ways for moisture to get into the panels and into the room (Figures 6.4 and 6,5). Check also that any internal partition walls are sealed so that moisture cannot get between sections.

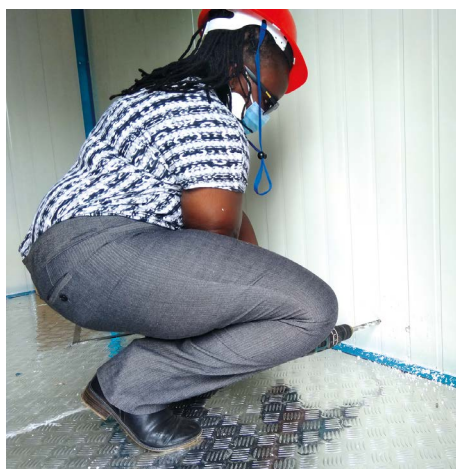

Figure 6.4

Holes can be drilled in the panels if needed, but have to be carefully insulated, reinforced and sealed to avoid heat and humidity infiltration (Sonja Mettenleiter, SelfChill).

⁷ Good practice for cutting and sealing holes in panels is explained in EN 16855-2 Walk-in cold rooms - Definition, thermal insulation performance and test methods, Part 2: Customized cold rooms, Annex D Guide on Installation.



Figure 6.5

Holes in the panels for refrigerant piping shall be cut no larger than strictly needed and carefully reinforced, insulated and sealed (*Sonja Mettenleiter, SelfChill*).

11. Ask what precautions are being taken to prevent or minimise thermal bridges, i.e. ways for heat to enter the structure (see Subsection 4.6.1).
12. During construction, check that no light is visible from inside the cold room in the corners and at panel junctions. A suitable and strong filler is needed for gaps bigger than 10 mm or so – most sealants are only meant to prevent moisture entering via closely fitting joints and should not be used to fill larger gaps between panels.
13. Check what is planned to protect panels from damage when moving goods and boxes around inside (and outside), especially if trolleys or trucks are used (e.g. kick-plates on lower faces of the wall panels or kerbing so trolleys do not hit walls).
14. Ask what pressure relief ('vacuum') ports are needed in the cold room (see Subsection 4.9.4).
15. Discuss the planned location(s) and ways to fix thermocouples and other sensors and equipment in place so that they are secure and do not interrupt workflow in the store (see Section 4.10).
16. Check what protection is planned to prevent rats and other animals burrowing or gnawing their way into the cold room (e.g. external metal sheet cladding near and below ground level, etc.).
17. If flammable refrigerants are to be used (propane, butane, etc.), check what extra precautions are being taken (see Section 4.8). Ask which relevant safety standards are being followed.

Ensure that the contractor provides written certification of the completed installation, including what checks have already been carried out, before moving to commissioning. This should cover electrical, refrigeration, insulated enclosure and safety issues (such as fire precautions, door opening from the inside and pressure relief).

6.1.5 Assembly of the cold room

There are some basic points to be considered if the cold room is being self-assembled, or to be checked with the installation team:

- The goal should always be to work towards a sufficiently tight connection in joints between panels to prevent moisture infiltration.
- Familiarise with the relevant technical drawings and floor plans showing the precise location of the components to be installed and plan the mounting order of the panels carefully before starting the assembly.

- The panels must be level before the locks are tightened, starting from the top. Ensure that there is a vertical alignment of the walls; do not proceed with panel mounting before the first panel is vertical (Figure 6.6). Check that the corners are at right angles and that the walls, ceiling, and floor form the intended shape.



Figure 6.6

Correct positioning of cold room panels before locking is crucial for future air-tightness (Sonja Mettenleiter, SelfChill).

- Those using welding equipment should ensure that strict safety procedures are observed when working on site during construction of panel stores because insulation burns fast and easily from a flame or welding arc.

6.1.6 Installation of the power system

The electrical system will require a qualified electrician to install it for safe and correct operation.

While electrical installation is beyond the scope of this guide, many resources are available to assist the electrician to meet local electrical codes and, in their absence, there are international standards that can be used. (Figure 6.7).



Figure 6.7

PV system control, charge regulator, battery box, cold-room control (Baridi).

PV installation will raise additional concerns, and not all qualified electricians are experienced with PV component installation (Figure 6.8). See Section 5.6 for reference documents that will assist designers and installers to recognise the unique considerations for safe and acceptable performance of PV power systems.



Figure 6.8
PV modules installation
(*Solar Cooling Engineering*).

Installation checklists for PV system installation for vaccine cold rooms can be found at the WHO website. The content shown below has been modified for use with any type of cold room covered by this Guide. It is useful for both installation planning and post-installation acceptance (before commissioning). All checks must be satisfactory before the installation is handed over to the user.

Check 1 Lists all system components (compared with the original design, useful for commissioning records).

Check 2 Is a summary of the receiving report noting shipping damage and if all parts were received.

Check 3 Lists specifications and 'as built' details for electric supply from PV array and generator, if included.

Check 4 Focuses on the battery installation, if included.

Check 5 Lists the load(s) supplied.

Check 6 Notes general wiring condition and pretests conducted.

Check 7 Summarises commissioning tests.

Check 8 Notes if system documentation has been provided.

Check 9 Notes overall acceptance and conclusions.

PV power system installation checklist		Date:
Country:	City/town:	Site name:
Installation company: Installation technician: Address 1: Address 2: Tel: Fax: Email:		

Note: All checks must be satisfactory before the installation is handed over to the user.

CHECK 1 – Hybrid power system description			
1.1	Supplier- Legal Manufacturer or Reseller:	Name:	
1.2	PV module:	Mfc./Model:	Qty:
1.2	PV module rating (STC*):	Volts; Watts:	Current (A):
1.3	PV array:	Watts peak (STC*):	Voltage open circuit
1.3	PV array configuration:	(e.g. 36 modules/3 series x 12 parallel)	
1.4	PV array structure:	Type of support structure (describe)	
1.5	Battery system:	Mfc./Model:	Qty:
	Battery: V and AH capacity (C/72 to 1.75 Volts per cell (vpc) at +25°C)	Battery voltage (nominal) Battery capacity	
	Type/quantity/wiring configuration (e.g. VRLA/48 cells/24 series x 2 parallel)		
1.6	Battery charge control(s):	Mfc./Model:	Qty:
	Control type/ratings:	MPPT, PWM, other:	V DC in A
	Control features:	Battery capacity indicator:	Other(s):
1.7	Inverter(s):	Mfc./Model:	Qty:
	Inverter type/ratings:	Wave form:	Watts (continuous) Watts (30 minutes) Watts (surge)
	Inverter features:	Inverter input/output volts:	Other:
	Generator:	Mfc./Model:	Qty:
1.8	Generator ratings:	Prime/continuous/other:	kW (continuous) Fuel storage (days)
CHECK 2 – Receiving Report			
2.1	Was the shipment damaged?	Yes No	
	If YES, describe damage:		
2.2	Were any components missing?	Yes No	
	If YES, list missing parts:		
2.3	Were any components under-supplied?	Yes No	
	If YES, list under-supplied parts:		

2.4	Were any spare parts missing?	Yes No
	If YES, list missing parts:	
2.5	Were any spare parts under-supplied?	Yes No
	If YES, list under-supplied parts:	
2.6	Have damaged/missing/under-supplied parts been replaced?	Not applicable Yes No
	If NO, describe action taken to complete the installation:	
	<i>Comments:</i>	
CHECK 3 – Power systems (for back-up power generator, refer to generator manufacturer's instructions):		
3.1	Back-up generator	Automatic or manual transfer switching:
3.2	PV array tilt/orientation (measure angle relative to the horizontal and measure compass orientation):	/ degrees
3.3	Do shadows fall on the PV array between 9:00am and 3:00pm?	Yes No
	If YES, confirm that the system design was oversized to prevent failure.	
3.4	Array support structure:	Anodised aluminium: Yes No
		Stainless steel: Yes No
		Galvanised steel (painted or unpainted): Yes No
		Other (material (describe):
	If PV array is detached is the structure firmly anchored on structurally sound foundation or other structure (e.g. roof)?	
	Is PV array accessible for maintenance and maintenance tools/supplies provided?	Yes No
	Have theft-deterrent fasteners been used for all accessible fasteners?	Yes No
3.5	Lightning protection:	
	Has the lightning protection circuit been correctly fitted?	Yes No
	Has the earth electrode been correctly fitted?	Yes No
	Has lightning protection system been tested for electrical continuity?	Yes No
3.6	Array cable:	
	Is the solar array cable type correct for external use?	Yes No
	Is the solar array cable protected against mechanical damage?	Yes No
	Is the solar array cable protected against rodent attack?	Yes No
	<i>Comments:</i>	
CHECK 4 – Battery installation		
4.1	Battery set and battery enclosure:	
	Accessible for maintenance?	Yes No
	Ventilated to the exterior?	Yes No
	Safely located to prevent accidental damage?	Yes No

	Secured against weather and theft?	Yes No
	Have battery safety and maintenance instructions been provided?	Yes No
	Is there a switch or other means to disconnect the battery?	Yes No
	Flooded batteries (where fitted):	Applicable Not applicable (go to 4.3)
	Are batteries leak free and undamaged?	Yes No
	Was distilled water supplied for future maintenance?	Yes No
	Has the battery safety equipment kit been supplied?	Yes No
4.3	Battery set and battery enclosure:	
	Is the regulator specified for the battery type (e.g. valve regulated lead-acid (VRLA), flooded lead acid (FLA), Li)?	Yes No
	Was the regulator preset in the factory?	Yes No
	Does the regulator have a battery capacity indicator?	Yes No
	Does the regulator have automatic temperature compensation?	Yes No
	Does the regulator have an optional acoustic alarm?	Yes No
	Spare fuses/breakers?	Yes No
	<i>Comments:</i>	

CHECK 5 – Loads

5.1	List load type(s), quantity and watts:	
	Cold room	
	Lighting	
	Monitoring	
	Communications	
	<i>Comments:</i>	

CHECK 6 – Wiring installation

6.1	Wiring:	
	Has the system been wired in accordance with the design wiring diagram?	Yes No
	Are all electrical connections concealed and properly protected?	Yes No
	Was site installed electrical wiring tested for safety and function?	Yes No
	<i>Comments:</i>	

CHECK 7 – Commissioning tests (see Part 6.2)

7.1	Commissioning: have all tests been carried out in accordance with the commissioning instructions?	Yes No
	If YES, describe/attach tests:	
	If NO, explain why tests have not been carried out:	
7.2	Are all hybrid solar power system components, all back-up power system and all loads functioning properly?	Yes No
	<i>Comments:</i>	

CHECK 8 – Documentation		
8.1	Documentation check:	
	Has a user manual been supplied for all system components?	Yes No
	Are user manuals in the correct language?	Yes No
	Has a technician’s manual been supplied for all system components?	Yes No
	Are technician’s manuals in the correct language?	Yes No
	Has an installation manual been supplied?	Yes No
	Is the installation manual in the correct language?	Yes No
	Has one complete set of documentation been given to the employer and one set of users documents been given to the responsible on site user?	Yes No
CHECK 9 – Overall conclusions and recommendations		
9.1	Recommendation:	Pass Fail
	If FAIL, list outstanding work still required:	
	If PASS, the installation can be handed over to the user.	

*STC - Standard Test Conditions.

Installation technician’s signature:

Authorised client or client representative

Date:

6.1.7 Cleaning and ventilating the new cold room

After removal of debris from the build, thoroughly ventilate the interior to allow odours from curing sealants to disperse, leaving the door(s) open for at least 24 hours (longer if in high humidity or low temperatures). Internal floor and wall surfaces should be cleaned for food hygiene purposes with soapy water or similar cleaning agent and rinsed, without use of abrasives or solvents.

6.2 Commissioning of the cold store

Commissioning takes place once the cold room has been set up by the contractor. This section identifies the critical components of the cold room that need to be checked, tested and measured. The commissioning process should be detailed in the contract between the supplier and buyer/manager with the steps well defined. Some checks should be done earlier during installation (e.g. floor or foundation) so that faults are fixed early enough to avoid long delays. The following section highlights components critical to effective commissioning and a checklist to adapt and use. Commissioning is crucial and it is strongly advised to have the support of an independent expert to represent the buyer/manager if the buyer/manager has limited experience of refrigeration plant.



Table 6.1

Overview of the key system components for commissioning checks.

Group	Component	Critical points	Assessment to be done during commissioning
Structural	Foundation	Quality of construction	Visual inspection, tape measure
	Housing	Quality of construction	Visual inspection
	Mounting system	Orientation & Inclination	Compass, Inclinometer
Electrical	PV array	Wiring circuit, open circuit voltage, current, equipment ground continuity (array to earth 5 ohms or less) Tilt and orientation	Multimeter. Optional hand solar radiation meter, Compass, inclinometer
	Batteries	Wiring circuit, voltage	Multimeter
	Charge controller	Wiring, voltage & current	Visual inspection, multimeter, control monitoring
	Inverter	Wiring, output voltage & current	Visual inspection, multimeter, inverter monitor
	Cooling unit	Wiring, voltage & current	Visual inspection, multimeter, monitor
	Fans	Wiring, voltage & current	Visual inspection, multimeter, operate when refrigerating and as specified during defrost
	Defrost heaters (if fitted)	Wiring, voltage & current	Operate on each evaporator, including pan heaters (where fitted) Termination sensor located in correct position Termination of heating as planned
	Cabling & fuses	Quality of wiring	Visual inspection
	Ground connections	Quality of construction, continuity	Visual inspection, multimeter
Thermal	Thermal storage	Ice formation	Visual inspection
	Insulation panels	Heat transfer/losses	Thermal imaging camera, cooling test
	Sealing, door	Heat transfer/losses	Thermal imaging camera, cooling test, infrared thermometer
	Refrigeration system	Performance under load	Set temperature achieved
	Liquid solenoid valves	On/off action	Closed during defrost and when the refrigeration is OFF
	Hot gas/cool gas defrost (if fitted)	Solenoid valves	Operation of defrost solenoid valves
Other	Spare parts	Availability of critical parts	Visual inspection
	System safety	System alarms, safety features	Visual inspection
	Refrigerant leak detector (if fitted)	Sensors, wiring	Check alarm operates properly
	System setting	Temperature range	Visual inspection
	Monitoring system	Mobile connection, data access	Visual inspection Position of control sensors and alarm sensors as designed
	Documentation	Documentation of system & system components, handbooks & certificates	Visual inspection
	Warranty	Warranty certification	Visual inspection
	Site security	Locks, guards, fence, lights	Visual inspection

6.2.1 Structural checks

The structural components include the foundation, the mounting system for the PV system and the housing. Depending on the place of installation, the structural set up might vary. A WICR that is set up within an existing building is less affected by environmental conditions than a standalone system set up in an unfortified terrain in the open air.

Foundation

The foundation should be sufficiently strong, flat and level. If the container is set up on a concrete floor, make sure insulation boards are used on the surface and sufficient spacing between the cold storage and walls is given.

If the cold storage is set up on a loose surface (sand, gravel, earth), check that the foundation is solid and of good quality. Depending on the size of the cold room it must carry up to several tons. The supplier usually has standards for the groundwork and foundation required for loose surfaces to carry their cold storage. During the commissioning process, the foundation is checked in its dimensions to verify it matches the supplier's specifications. Check that the cold storage is stable and set to the foundation in an ideal position, so that the weight is distributed to the complete surface of the foundation. Visually check for any cracks or other damages to the foundation.

Example installation: for a 20-foot container, 4 bolted concrete pillars were set into the loose ground. The pillars were 0.8 x 0.4 x 0.75 m (length, width, height) and were dug 0.5 m into the ground.



Figure 6.9

Strong, flat and level foundation is crucial for walls integrity and air-tightness also in the presence of heavy loads (*Inficold*).

Outer shell

Visually inspect the outer shell of the cold storage to see if any damage occurred during assembly. Systems that are installed in the open air (e.g. containerised systems) are susceptible to rust damage if the outer paint or varnish has been damaged during shipping.

Mounting system for the solar array

See Part 5, "Power Systems" for comprehensive guidance on all solar power system aspects, including mounting systems.

6.2.2 Electrical Commissioning

A qualified electrician is required to carry out a comprehensive commissioning check at time of hand over. The power system supplier is to specify the correct connection sequence, wiring configurations and acceptable performance as evidenced by their specified commissioning procedures. A multi-meter is required to assess correct current, voltages and ground continuity against the design specification. All components need to be operated with evidence presented that all operate safely and correctly.

PV Modules

PV modules must be checked for any damage during transportation and installation. Prior to installation – or if necessary, during troubleshooting – the open circuit voltage and polarity should be checked at the PV output and cross-checked with the manufacturer information on the label of the solar module. Checking current output is more complicated than open circuit voltage measurements as current (amperage) is directly related to the solar radiation on the array. Good quality control systems can verify current (or wattage) input performance. Alternatively, a handheld solar radiation meter can indicate instantaneous solar radiation (in watts per square meter) and current input measured at the same time can indicate if performance is as expected.

Batteries

If batteries are part of the system, check the wiring circuit is correct (connection in series and parallel) and check the voltage of each battery. Specific gravity of flooded lead acid batteries may be required to determine battery health. Cross-check with the manufacturer information on the label of the batteries. Visually check for correct connection and physically confirm all cable connections are as per manufacturer's specification (e.g. torque on connector bolts).

Charge controller and inverter

Charge controller is used when batteries are part of the system, while the inverter is required to transform the PV generator's direct current (DC) into alternate current (AC). Incoming and outgoing voltages and currents should be measured and checked with the information of the component's data sheets. Charge controller and inverter monitoring can be used to obtain voltage and current without interrupting operations. Check that controls and inverter have threshold for power, current and voltage that cannot be exceeded and confirm loads can operate within those parameters to prevent load damage. Visually check for correct connection of cables and check physical connections are as per manufacturer's specification (i.e. bolt torque).

Cooling unit fans and lights

The main consumer of the power is the motor that drives the compressor of the cooling unit. Fans are required for forced air circulation and more uniform cooling. Check that fans run in the correct direction. Visually check for correct and firm connection of wires. Check that lights within the cold storage are working properly from all switches.

Cabling and fuses

Check that all cables are installed and anchored into position tidily, no loose or hanging sections of wire, no damaged insulation and use of correct colour codes. Check that all fuses are in place and labelled.

Ground connection

Check that an earth ground connection is installed and connected. It should have a length of approximately 2.5 m (standards as in the US and Germany) and be installed vertically into the ground so that only sufficient height protrudes to make a sound electrical connection to it. Comply with any national norms of the country of installation. Confirm continuity throughout the system at time of commissioning.

User information and training

Ensure that all component specification sheets, the wiring diagram and instructions are saved and consolidated into a complete file to be left on site. Ensure that disconnect switches, overcurrent devices (fuses and/or circuit breakers) and all cables are clearly labelled. User training is essential and must be provided at time of commissioning and handover.

6.2.3 Thermal commissioning

Many thermal processes are ongoing in the cold storage, depending on the type of system so allow plenty of time for this part of commissioning. A hand-held thermometer (indicative cost USD20) is essential for commissioning and cross-checking the function of system temperature gauges – get the thermometer calibrated or check it first against a known cold temperature. Simple calibration can be done using a cup of mixed water and finely crushed ice (slush); if it is made with pure water (no salt or additives), then the liquid will be at 0°C as long as some solid ice particles remain, and it is regularly mixed. A handheld thermal detector is also very useful for a better assessment of cold room functionality – this is an infra-red thermometer which can measure the temperature of a surface at which it is pointed from a distance of a few metres (indicative cost of USD 50 to 100); look for models that project a laser or light beam to identify the measurement point. For a full visual assessment, a thermal imaging camera would be ideal (indicative cost of USD 400+ but available for hire from specialists), Figure 6.10.



Figure 6.10

Inspection with infrared camera allows detecting poor sealing and thermal bridges. (Sonja Mettenleiter, SelfChill).

Evaporators and ice thermal storage

Visually check evaporator plates for external damage. Scrapes and scuffs in varnish or paint can lead to corrosion, especially if the system uses saline solutions for thermal storage. Evaporator plates should be completely submerged in the medium. Check for any bubbles from submerged pipes and plates that could indicate a leak of refrigerant. Check for the formation of ice around the evaporator: ice should form reasonably uniformly around the plates (though this may take many hours). Check that the circulation system is working (medium is pumped from the thermal storage to the heat exchanger and back into the thermal storage).

Many cooling systems use a thermal energy storage (TES) to transform and store energy for later use. During commissioning, the condition and positions of any TES units should be checked to ensure their safe and reliable operation. See also the thermal energy storage design Section 5.5.

1. Check that appropriate TES units have been specified and installed by looking up the certification documents of the installed TES units: for optimum performance, the most often used cold-room set points should be 2°C or 3°C lower than the temperature at which the TES unit filling changes state (melts or freezes).
2. Visually check the installed TES units for any damage or leak. Remove and repair or replace any damaged or leaking TES units.
3. Ensure all packaged TES units are exposed to cold airflow, i.e. airflow is not blocked or diverted away from surfaces of the TES. This is to ensure that they can be cooled ('charged') to store cooling for later use. Adjust/reposition TES units or air flow within the cold-room until TES surfaces are properly cooled by the airflow.

Insulation panels

Check for punctures of the skin of panels as they could lead to moisture getting inside panels, which rapidly degrades their insulation value. Fix punctures or tears in a permanent way (e.g. with suitable epoxy adhesive/filler or silicone). Visually check for the integrity of insulating panels to verify good sealing as described below. A thermal imaging camera can quickly locate problems with insulation and seals, but careful checks with a directional surface thermometer can also be effective. Once the refrigeration system has been running for a few hours, the inside walls should have a reasonably uniform cool temperature and any warm spots could indicate a heat bridge, fault in the insulation or air leakage. If cold air from the evaporator is blown directly at a wall, it may form a particularly cold spot that will accelerate heat leakage and air flow should be redirected (possibly with a baffle plate). An assessment should also be done from the outside, where problems are indicated by lower temperature spots (perhaps revealed by formation of condensation).

Sealing/door

Visually check for a proper sealing in between all insulation panels, especially in corners, cut surfaces and the door. All panel seams must be tight and free from air leaks. Also, all services that are passed through the insulation (refrigeration pipes, electrical conduits, plumbing) must be sealed with a compound that stays flexible. Air and moisture leakage leads to heat losses, higher running costs, decreased efficiency and possibly failure of the insulation or panel structure.

An initial visual inspection for sealing can be to check joints from the inside with closed door during daytime: any sign of light from outside means faulty installation. Check for effective sealing of the door by trying to push a piece of card or paper between the seal of the closed door and the frame – the joint should resist the card, and once the card is between seal and frame it should be held in place. A thermal imaging camera can also find problems on the door and its seal. Depending on the airflow from the evaporator, some sections in the cold room (e.g. internal corners) may not get as cold as most of the walls; if the temperatures vary smoothly and are only a few degrees warmer, it may not be a seal or insulation problem. Abrupt temperature changes, however, indicate a problem. Handheld thermal detectors (infrared surface thermometers, see first paragraph of Subsection 6.2.3) are cheaper than thermal imaging cameras but only give single point measurements, rendering checks more laborious.

6.2.4 Refrigeration system commissioning

If the cold room is installed on a freshly-laid concrete floor, allow drying time to avoid floor damage by ice formation (this could take several days).

If the WICR allows hybrid operation, it may make sense to do the first commissioning stage powered by the grid, if available. Tests with the alternative power source can follow when the refrigeration plant is known to be running well.

Slowly cool the room to the design operating temperature. This should be carried out gradually, especially with large rooms. This reduces the risk of collapse of the structure if a pressure relief valve is not fitted or not functioning properly – that can happen when the volume of air shrinks rapidly through cooling and the pressure cannot equalise through air flowing inwards. Where a cold room has a non-insulated floor, it is recommended to cool down slowly and not to exceed the temperature reduction rate of 15°C per 24 hours down to the design operating temperature, so that the floor is also cooled gradually and temperatures that are representative of the whole structure are being recorded.

During initial cool-down, the following precautions should be taken:

- Use temperature loggers to track the temperature in the cold store.
- Where possible, do not initially operate all the evaporator fans at once – stage their operation to give the system a 'soft start'.
- Wedge the cold room door slightly open, just enough to allow some air flow as it cools, until close to operating temperature. Place a sign to ensure the door is not fully closed during this period by a well-meaning colleague.
- Check that the pressure relief ports are operating correctly by checking they are clean and clear of debris and not obstructed in any way. Lubrication may be required – check with the supplier.
- Monitor the key refrigeration system parameters to ensure that the plant operates as is planned, according to parameters that the designer should be able to provide (see Subsection 4.10.2).
- If thermal storage is included in the system, allow time for the storage to be fully charged, then cover the solar panels or cut the power supply and log the temperature rise to assess the autonomy time (see Section 5.5). The designer/manufacturer should specify the cool down time required to fully charge the TES.

Once the design operating temperature has been reached, check the cold room, inside and out, for any signs of condensation or air leakage that indicate a faulty seal. Feel and listen for air movement along joints and seals, especially as the door is closed and opened. Rectify and ensure the agreed design parameters are being met (Figures 6.11 and 6.12).



Figure 6.11

Condensing and evaporating pressures are key parameters to check the correct operation of a refrigerating unit (*Cortella*).



Figure 6.12

Every cold room should be equipped with a thermometer for monitoring the correct air temperature inside the refrigerated space (*Solarcool*).

Check that each alarm is functioning correctly (see section on system safety below). Check that the access door can be opened from inside so that no one can get trapped in the cold room.

6.2.5 Other system checks

Spare parts

Check that spare parts as contractually agreed are available and stored safely and accessibly. This is especially important for parts that are only available from the manufacturer (who might be located on another continent). Spares should (or could) include:

- Main printed circuit board (PCB)/control unit
- Solar interface PCB
- Switched mode power supply (SMPS)
- Inverter
- Charge controller
- Fuses

System safety

See Section 4.12 on design for safety. Check that all system alarms are set and functioning. This includes alarms on:

- Fall below minimum or exceeding maximum set temperature
- Thermal storage critically low
- Battery storage critically low
- Door open
- Any connection lost to sensors

Check how the alarms are transmitted (display, alarm LED, remote text message) and that documentation (see below) is complete to interpret alarms.

System setting

Check that the system is set to the desired parameters in terms of temperatures, alarms, time of operation and others.

Remote monitoring system

Check that the remote monitoring system (if installed) is working; this requires a SIM card and a mobile connection. Cross-check that uploaded values match with measured values.

6.2.6 Before signing off commissioning and handing over the plant

Training of operating staff

The plant should be running smoothly after commissioning, but it is important that staff on the site are given the information they need to keep it running well and spot problems. Staff on the site do not need to understand everything about the equipment (though that would be ideal), but at least one person on duty at any time should have received briefing or training. Ensure that staff can confidently run the plant and recognise when corrective action is necessary. See also Section 7.10, 'Maintenance of the cold room'.

Training should cover:

- The technical features and components of the cold room (which components are where and what they do).
- How to use the instruction manuals and plant diagrams and where they are stored, with a focus on the troubleshooting guidelines (diagnosing and resolving simple problems with the plant).
- How to set the temperature, humidity and other parameters that the controls are designed to enable.
- If a smartphone app is used to control the cold room, proper training to use the software.
- How the alarm systems work, what alarms mean and what to do to resolve alarm conditions.
- What monitoring of components of the solar system is needed, such as battery, panel, inverter, etc. and how to spot problems (see also Part 5, “Power Systems”)
- Regular maintenance, cleaning and servicing of the system (see Part 7.10).
- How to use the facility safely and what the key risks to staff and users are.

Documentation

Check that the agreed documentation is handed over, to ensure safe and efficient operation of the WICR. This should include:

- Contact details of the installer (name, phone number, email).
- User manuals (including the operation of alarm systems, troubleshooting simple faults and details of all control settings).
- A complete set of installation drawings, together with refrigeration system piping diagrams, electrical wiring schematics and refrigeration and electrical component lists including data sheets.
- The design operating parameters and a record of parameters at commissioning.
- Operation, service and maintenance instructions for all major components used in the installation.
- A list of recommended spare parts for critical equipment.
- Copies of records of the commissioning procedure and checklists.
- Warranty certificates.
- A system logbook in which the information identified in the list below can be recorded. The logbook can be in physical form, or intermittent printouts of a digital version.

A copy of these documents should be kept on site in an agreed, safe place that is easily accessible and known by the operators and maintenance staff.

Logbook

The logbook covers the history of maintenance and servicing of the refrigeration system and other main components. The logbook should include, as a minimum:

- Results of checks and tests.
- Details of all maintenance, servicing and repairs.
- The amount and type of refrigerant that has been used to initially charge the system, and date and amounts added to replenish the system. This is very important to track and fix refrigerant leaks.
- Components that have been repaired or replaced.
- Changes that have been made to settings of controls and alarms.
- Observations noted of any potential or ongoing issues or faults.

Identification plate

The refrigeration system should have a permanently fixed identification plate located somewhere easily visible that shows the following information:

- Brand and/or name of the manufacturer.
- Model, reference number and serial number.
- Refrigerant designation (R-xxx number).
- Refrigerant charge (kg).
- Maximum allowable high-side and low-side pressures (Bar or Pa).
- If a flammable refrigerant is used, the flame symbol with a minimum height of 10 mm.
- Date of installation.

The owner or operator in charge should add to this the details of whom to contact in the case of problems with the equipment.

Maintenance

Ensure that a maintenance plan is in place with daily, weekly and six-monthly procedures. Maintenance procedures are explained in Section 7.10, 'Maintenance of the cold room'.

Site security

Measures for site security against theft and damage could include:

- Keeping the site clean and tidy, with loose equipment always put away securely after use.
- Means to lock the door of the cold storage in a way that it can always be opened from inside to avoid anyone being trapped inside (risk of hypothermia and suffocation).
- Security fencing and motion detecting lights (if required).
- Security guard (if required).

7

Operation and Management of Walk-in Cold Rooms

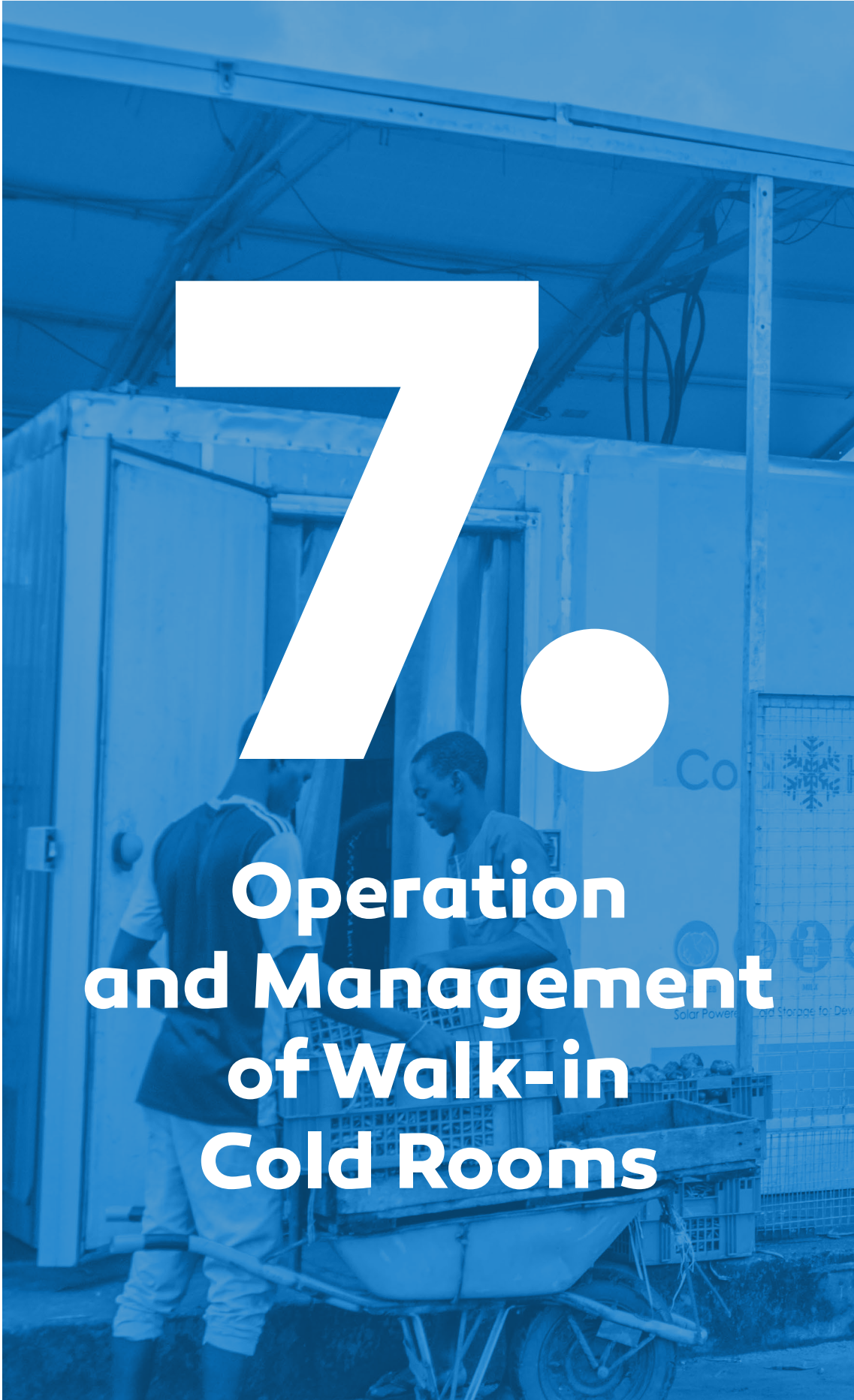

7.

Operation and Management of Walk-in Cold Rooms

7.1 Introduction to cold room operation

Effective agricultural production is beyond the scope of this guide, but for efficient operation of cold storage, one requires knowledge of cropping patterns, production cluster formation, selection of the right products and inputs (seeds, irrigation, machinery) and seasonal timing through to harvesting. Part 2 of this guide covered the storage needs of produce and Parts 4 and 5 addressed the technologies to produce the cooling, store the produce and provide the energy needed to run it. Availability of the right hardware is a step towards a successful cold room business, but the cold room must be well-managed and operated to be viable, with careful postharvest management of produce. That is the subject of this section. Overall, for effective and sustainable operation of the cold room, understanding what the farmers are producing, when they are producing it, and what volumes they should store for future sale at which point are all critical and influence both the design and operation of the cold room.

7.2 Overview of an operational protocol for cold room management

Part 2 'Fresh food storage considerations' describes the science behind the care of produce, and the important factors for maintaining quality for an extended period. The day-to-day operation and management of the cold room can be achieved through developing and using an operational protocol on a daily basis.

The protocol will necessarily be adapted to the local situation but consider including all relevant aspects in this Part, from section 7.2 to 7.11. The first consideration is who is responsible for which duties and when, plus some rules for all those who visit and use the facility. Some basic definitions for the protocol are suggested in Table 7.1.

Some basic cold room rules should be established, for example:

- Only staff of the cold room facility may enter the cold room.
- Depositors must report to the cold store manager on arrival.
- Doors must be kept closed as much as possible; always closed after passing through; not wedged open.
- Lights are switched on only when staff are inside the room.
- The power supply is only to be used for the electrical needs of the WICR.
- Basic hygiene rules must be followed, including washing hands and cleaning of crates, racks, walls, doors and handles.

The science described in Part 2 must provide the basis for the day-to-day management of the cold room operation.

The protocol should also include a checklist for cold room operation. The list below serves as a reasonable starting point but the detail must be developed to suit the application and operational approach. The checklist should also be reviewed and improved regularly – perhaps every 3 months – and especially whenever operational conditions are changed. Group the checklist items according to when and how often they are to be done, creating perhaps a daily list, a weekly list and lists based around specific events (such as a large delivery):

- The door closes properly and easily; door management process and monitoring are in place.
- Lights are switched off when not in active use.
- Temperature is correctly set and sustained for the current load.
- Relative humidity is suited to the current load.
- Ethylene levels are under control.
- Temperature is monitored and recorded at least 2 times each day.
- An inventory inspection schedule is in place, and any damaged/decayed produce is always removed.
- A software interface is recommended to optimise the room operation, the crop storage, and connecting farmers to their markets.
- Inventory management process is in place and followed – produce is labelled, dated and managed properly (with first in/first out).
- The cold room is cleaned and tidied regularly according to a schedule.

Table 7.1

Basic definitions for a cold room operational protocol.

Cold store manager/Storage operator	Manager of the cold store complex responsible for the daily operation of the facility
Logbook of ‘storage’	The logbook of the storage facility, in which all actions, experience, technical problems and other matters related to the storage are reported
Storage facility owner	Owner of the storage facility, storing their fruit and other product or product from a third party (depositor). Makes business decisions.
Depositor	Owner of fruit or other product to be stored at the facility

7.3 Keep the cold room clean and tidy

After commissioning and before starting to use the cold room, it must be cleaned to a good food hygiene standard, not only removing dust and dirt from construction. The floor, walls and ceiling should be cleaned with water and detergent. Components within the cold room should also be cleaned such as valves, pipes and evaporators. See Subsection 6.1.7.

A schedule of regular cleaning and tidying of the cold room should be set up and consistently followed. This is important not only for protecting the stored produce from cross-contamination and accelerated decay, but also to ensure that users respect and look after the facility so that it is managed and run efficiently and effectively.

Clean the walls with a mild detergent solution and cloth; avoid abrasive detergents and strong solvents. Do not use high pressure hoses to wash walls as this damages the adhesive and vapour seal in joints.

The cold room should be precooled to a temperature below the intended set point at least one day before loading the first product. If thermal energy storage is included the cool down time may be longer to both bring WICR temperatures to an acceptable range and cool the thermal storage sufficiently to provide the design autonomy.

7.4 Planning temperatures for the storage of produce

The optimum storage temperature for fruit or vegetables is the lowest temperature that they will tolerate, whilst ensuring no freezing or chilling injury from temperatures set too low. In addition, humidity and air speed control in cold rooms must be balanced to give optimum conditions. These factors are explained in Section 2.3 along with tables of recommended temperature and humidity levels for optimum storage of many types of produce.

The protocol and staff training must be clear about what temperature is meant, i.e. spot temperature, time integrate average, product core, air and coldest or warmest location. For all conditions it is important to describe the range and to judge if this range and level are possible with the equipment, the intended produce and throughput.

Different produce has different storage needs for temperature, relative humidity, and level of ethylene production and tolerance, plus chilling sensitivity (Section 2.3). Storage of single commodities is simple and safe, but it is almost always necessary in practice to store multiple types together.

Plan to store together produce that is accommodated by one of the three recommended compromise conditions for short term storage (see Subsection 2.3.6):

1. Cold and humid (0-2°C; 90-98% RH) – most leafy vegetables, brassica crops, and temperate-origin fruit and berries.
2. Cool and humid (7-10°C; 85-95% RH) – citrus and subtropical fruits and many fruit-type vegetables.
3. Moderate (13-18°C; 80-95% RH) – root vegetables, squashes, and most tropical fruit and melons.

Avoid co-storage of produce that requires a different temperature and humidity.

Some deviation of temperature will occur over time and between specific locations in the room – the agreed storage conditions are the optimal levels or may be described as a range (minimum and maximal level). The important temperature in all situations is the product core temperature and should ideally vary no more than $\pm 0.5^{\circ}\text{C}$; if this is not met, then the system setting and/or air circulation should be adjusted. Large temperature differences should be reported to the cold store manager and recorded in the logbook (decide what level of temperature difference is seen as 'large' for the situation, but for example, '> 1.5°C for more than 2 days'). If damage to produce occurs or there are other quality losses, this must be reported to the storage facility owner. Product quality issues found during inspection should be reported to the cold store manager.

The recorded temperature should be the integrated mean temperature of all sensors, and this should include the coldest and warmest places in the room. The locations of the coldest and warmest positions can be determined during a cold room stabilisation period using a hand-held temperature sensor.

The cold store manager/storage operator will make all efforts to ensure the agreed conditions are met, but in case of technical malfunction, the range may be exceeded for some days and the protocol should address this. The cold store manager/storage operator should inform the depositor and storage facility owner promptly.

The operational protocol should also cover the situation where the depositor of the produce requires storage conditions different to those recommended by the cold store manager. The difference should be recorded in the logbook along with the remark that the storage facility owner will not take responsibility for the impact of the agreed different conditions.

7.5 Other considerations for co-storage of produce – ethylene and odours

Two additional factors restrict co-storage options: ethylene gas and odours:

1. The science and issues regarding ethylene are explained in Part 2. Ethylene 'producers' should not be stored with ethylene-sensitive fruits, vegetables, or flowers or there may be a loss of quality, a reduction in shelf life, specific injury symptoms and changes in colour, flavour and texture. Ethylene producing produce includes apples, avocados, bananas, pears, peaches, plums and tomatoes. Ethylene sensitive produce includes lettuce, cucumbers, carrots, potatoes and sweet potatoes.
2. Odours (and flavours) can be transmitted between co-stored types of produce. Odour transfer is almost always undesirable, but some combinations are particularly ruinous. Storage combinations that should be avoided due to odour transfer include:
 - Apples/pears with celery, cabbage, carrots or onions; potatoes acquire an unpleasant taste if stored with pears or apples.
 - Celery with onions or carrots.
 - Citrus with strongly scented vegetables.
 - Green pepper will taint pineapples.
 - Onions, nuts, citrus and potatoes should not be stored together in any combinations.

When co-storage is necessary, the storage conditions of the produce batch with the less extreme storage conditions should be applied (highest temperature). For co-storage, not only the temperature conditions are important but also any sensitivity to moisture loss: moisture sensitive produce should be shielded, e.g. using a plastic cover. The chosen condition should be recorded in the logbook.

7.6 Optimising utilisation through the year

Given the high investment, continuous use of a cold store throughout the seasons is often needed to ensure economic viability. A store that is empty for weeks or months is unlikely to be profitable. But a store full of produce that will go off before it can be sold or that cannot reach a price covering costs is also going to struggle. Optimum utilisation must consider how full the store is, the (potential) value of the produce and the timing of storage and sale.

To enable fully flexible year-round utilisation, a WICR should be designed to function at a range of temperatures (ideally from 0°C to 15°C, but see 2.3.8 for further advice), unless the business plan specifies otherwise. Storage temperature needs in a WICR will vary whenever crops change during seasons or due to market demands.

High utilisation can often be achieved through creative thinking with ideas including to seek out storage of alternative products during off seasons – bananas are a year-round crop; cool water for local sale; consider other drinks, dairy products, packaged perishable foods.

7.7 Managing receipt and loading of produce

7.7.1 Limit produce temperature before storage

Keep produce under shade after harvesting until stored. To assist this, provide a shaded area to receive goods for the cold room. When shading, ensure that air can continue to circulate around the produce: do not drape covers tightly over piles or boxes. If there is insufficient structured shade, produce can be covered with dry banana leaves; spray with clean water occasionally if available.

Minimise the delay between harvesting and cooling, aiming for 1 to 2 hours maximum. See Part 2 Table 2.3 for target times between harvest and cold storage for particular produce types. This means having well-rehearsed goods receipt processes but also trying to influence the proper management of storage temperatures during the supply chains up to delivery to the cold room: effort to improve that will protect the quality of all stored produce (El-Ramady et al, 2015; Bachmann and Earles, 2000).

7.7.2 Registration of incoming produce

The protocol should address the following:

- If a batch seems not suitable for its described storage time or conditions or is not suited to the planned conditions in the cold room in that period, the protocol must suggest how this is resolved; decisions should be reported in the logbook.
- A product quality check should be done at reception for each batch of product coming from one origin (orchard/field/harvest date).
- All crates should have clear labelling and a record of registration.
- Positions of different batches within each room should be registered in a floor plan/stacking scheme of the room.
- Registration is the responsibility of the cold store manager/storage operator.

Check and accept batches of product, registering the following:

- Name of contractor.
- Name of person responsible to decide storage conditions of the batch.
- Description of product (type, variety and other specifications, quantity).
- Required storage conditions (temperature and range; relative humidity; ethylene control measures).
- Date and planned period of storage.
- Signature of contractor.

7.7.3 Grade and sort produce before storage

The harvested produce must be graded and sorted because decayed or spoiled items affect the quality of produce stored alongside and increase spoilage (Figure 7.1). All batches should be checked regularly for quality (Figure 7.2). The frequency and traits to be inspected will vary depending on product type but should be at least weekly, according to a schedule specified beforehand, with results recorded in a logbook. Quality issues must be logged, and the cold store manager/operator should inform the storage facility owner and the depositor of damaged produce. Some produce may require washing, disinfection, drying or packaging before storage.



Figure 7.1
Sorting and grading of mangoes
(The Daily Star Weekly Magazine, 15 July 2011).



Figure 7.2
Quality check of the produce before
storing in the cold room (*Coldhubs*).

7.7.4 Precooling of produce

Precooling is the removal of field heat from freshly harvested produce to slow metabolism and reduce deterioration before storing or transporting the commodities. The science and approaches for precooling are described in Part 2 section 2.3.2, and the heat load and technical design issues are addressed in Part 4 section 4.3.4. Produce should be pre-cooled as soon as possible after arrival on site, before moving it into the main storage area. Supplier instructions for use of precooling must be followed and not exceeded.

7.7.5 Careful loading and stacking of produce in the cold room – avoiding overload

Each cold room should be filled with produce spaced as evenly as possible, which allows the best possible airflow and storage conditions. It is important to allow airflow to reach under the load, between pallet loads and over the top of the containers to maintain the target temperature. It is best to store together produce that is as uniform as possible in terms of variety, type and harvesting period. In case the room is not completely filled, the crates should be stacked to avoid short-circuit airflow in the empty space between the evaporator and the products: partly loaded rooms will give more variation in product temperature. Settings of the control temperature sensor (probably lower values), the air on/off temperature difference and air circulation should be adapted to achieve the advised temperature.

If the cold room is overloaded, temperatures will drift out of specification and quality suffers. Bear in mind that overloading can arise from two different situations:

1. If there is simply too much produce in the cold room, so that airflow is choked and combined with residual heat and respiration heat, the ability of the store to keep produce at target temperature is compromised.
2. If the rate at which warm produce is being loaded in is too high: this should not cause problems if the produce is pre-cooled, as the cold room refrigeration system must only maintain the same temperature (countering heat through the insulation and air exchange). But if produce is being loaded without precooling or with inadequate precooling, loading rate may have to be limited to safeguard quality of the produce already in the cold room and ensure that the cold room system can achieve the correct temperature. Without precooling, even a half-full cold room may be severely over-loaded and unable to achieve correct temperatures.

To avoid overloading the cold room, use precooling and respect the maximum stacking limits.

If precooling is not available, then check (or learn) what capacity or loading rate the specific cold room can cope with. Experience with early standalone off-grid solar powered cold rooms without precooling shows that the loading rate should be limited to between 1 and 2.5 percent of the system's total capacity at a time (Krishnakumar, 2002). For a 20' trailer sized cold room (33 m³) rated at a capacity of three tonnes, this might mean that only 3 or 4 crates of warm produce can be loaded at a time, then allow temperatures to get back into specification before loading more.

The racking and loading pattern are important elements of cold room design for its capacity, utilisation and performance. Produce must be loaded into a WICR with consideration of the airflow to ensure adequate air circulation around the produce, whether it is already cool or not. Blocking airflow will prevent the cold room from operating effectively and can lead to warm areas and degraded produce. Aligning the pallet skids to run parallel to the direction of the cooling air (i.e. towards the refrigeration system) will create a more efficient air circulation.

Produce should never be stacked against the cold room wall, and it is recommended to leave a gap of at least 10 cm for air to circulate. These gaps allow heat transferred from the outside environment to be carried away in the room air and prevents warming up of the stored produce. More so, a clear air space of 25 cm or more should be left between the fan unit and the top of stacked pallets or bins. This will allow the cold air to move over the top of the storage contents, rather than being blocked by products nearest to the refrigeration unit.



Figure 7.3

Clear air space on top of the produce to allow cold air circulation from the cooling unit (*Coolcrop*).

Do not place produce containers directly on the floor – use racking or pallets to ensure air circulation between the floor and produce. The produce should not obstruct the discharge air and return air outlets to maintain good cold air circulation within the store. Produce should not be stacked so closely together that cold air circulation is blocked, but stacked in ways that allow airflow. Explain to staff how to do this.

The containers used for holding the produce must be well ventilated and strong enough to withstand stacking. Use packing crates and boxes that have long slim vent holes instead of round holes as slots are less likely to get blocked by the produce. Aim for ventilation holes that occupy 5% or more of sides and top faces of boxes. Consider use of shaped box liners or trays to separate and stabilise produce inside the containers. But ensure the type and condition of packaging materials (cushioning, liners, wraps) do not block vent holes nor allow the heat of respiration to build up inside the containers.

The produce should be organised for easy identification and tracking – consider quick and easy forms of labelling or colour coding of containers.

A loading diagram or schedule should be kept up to date to always know what is stored where, to minimise the time that staff have to stay in the room and for which the door is left open.

Checklist for cold room loading:

- The room is clean and tidy.
- All door seals are in good condition.
- The refrigeration system is operational and the target temperature is achieved.
- Co-stored products are compatible with one another.
- Produce is pre-cooled to within 5°C of the target temperature before storing (ideally).
- Stacked containers are at least 10 cm from walls.
- The cold room is not overloaded.

7.8 Monitoring for operational performance

As described in Section 4.10, monitoring reveals the performance of a WICR in two main dimensions:

Technical performance (addressed in Section 4.10): is how well the WICR performs the function of cooling (i.e. engineering and technical performance of the refrigeration plant and insulated envelope, including electricity production and consumption, achieved air and produce temperatures, autonomy, etc.).

Operational performance (addressed in this section): when combined with business planning, operational monitoring shows how well the WICR operates in situ and to what extent it is in sync with the intended business model. For solar-powered equipment, this can be combined with solar irradiation forecasting or routine weather forecasts to predict power availability a day or days in advance, and plan to mitigate deficits or exploit surplus power situations. Monitoring for operational performance requires understanding of many activities, including:

- The operational temperature and relative humidity for food quality and business effectiveness.
- Throughput of produce.
- Cold room utilisation level.
- Door opening management.

- Costs of running the plant.
- Types of produce stored (to match with temperature and relative humidity).
- A system to warn users in advance if loading will be limited during poor solar gain.
- A system to flag when excess cooling capacity is available during clear skies and low utilisation so that extra demand can be found and the capacity is not wasted.
- In the case of 'pay as you store', to understand who is storing produce, in what quantities and for how long.

Some of this monitoring is suitable for automation; some must be manually recorded.

Conditions in the cold room must be monitored to ensure optimum food preservation and to scan for systems faults. Any failure will affect the business and cause spoilage of produce.

Especially during the first years of experience with new storage rooms, manual checks of product temperatures should be carried out daily. Small differences in stacking will affect local product temperatures and this can be verified by careful manual checking to optimise.

Business success depends upon the measured values of monitoring and control equipment being always reliable. This means that if there is reason to believe that any recorded values are not reliable, then action must be taken to investigate and improve the processes. Regular use of manual temperature checks avoids complacency about automated measurements. Both manual and automated measured values should be reported in the logbook. The location of temperature sensors and what exactly should be checked is discussed in 4.10.4 and especially in Table 4.3 in that section. The suggested frequency of temperature measurements is shown in Table 7.2.

A key monitoring requirement for operational performance is inventory management, which can be done by manual means (see Subsection 7.9.1) or increasingly using automated software assistants (see Subsection 7.9.2).

Table 7.2

Suggested frequency of temperature measurements.

See also Table 4.3 in 4.10.4 for further guidance on sensor location for monitoring.

Measurement type	Suggested frequency of temperature measurements
Manually	If no automated measurement, then each room at least twice daily. Calculate an average temperature but also recording the warmest and coldest location. Register in logbook.
Automatic (if available)	Continuously recorded (product temperature at least each hour, control and precooling temperature every 30 minutes if possible)
Additionally by hand	As a cross-check of the automated system, at least once every 7 days via direct product measurement. Record in logbook

7.9 Inventory management

7.9.1 Inventory management using manual systems

Proper record keeping is required to track the cold room availability and profitability for better management. The business model must be studied on a regular basis to implement innovative measures and maintain strong performance. The operator should monitor the temperature and relative humidity maintained in the cold room, the quantity of the commodity, its shelf life and stacking arrangement. The operator should ensure to follow a 'first in/first out' principle to avoid decaying produce left behind (decayed produce spotted in the scheduled stock review comes too late to sell it).

A sample format for manual inventory management is shown in Table 7.3. The values can be written on paper, but a digital log is preferred to better trace the quantity of produce, how many days it is stored and the frequency of each customer. The prices at time of loading and time of removal can be estimated from knowledge of local markets or from one of the many apps that are available to assist farmers.

Table 7.3

Example of a manual inventory management proforma.

Monthly commodity report of cold storage: <i>[insert name of cold room]</i>									
For the month of: <i>[insert month and year]</i>									
Small holder farmer name	Stock In				Stock Out				Spoilage
	Date	Name of the commodity	Quantity	Price during stock in	Date	Name of the commodity	Quantity	Price during stock in	

7.9.2 Inventory management using app-based platforms and digital twins

Whilst most decentralised cold storage facilities still use manual registry systems, more and more are offered with a smartphone platform to check on the commodity storage period, room temperature and relative humidity, which helps the operator or user to correctly maintain the desired condition inside the cold room. Some of these third-party remote monitoring applications include market analytics and crop management options (generally neither sourced nor controlled by the cold store hardware supplier).

EXAMPLE OF A 'DIGITAL TWIN' TYPE INVENTORY MANAGEMENT SYSTEM

Through their project 'Your Virtual Cold Chain Assistant', BASE and Empa are developing an open-source mobile application that also includes physics-based 'digital twins' of the crop which is being stored, pre-programmed to model how preservation of the real crop should proceed (Motmans, 2022). The modelling is estimated based on real-time data measured from sensors within the cold room (such as temperature and humidity). The digital twin simulates produce degradation as it is being stored to help inform cold room users on when is the best time to pick up their crops. It can also support management decisions to optimise the operation of the cold room to have the best quality crop for the longest period, whilst minimising energy usage. The starting point can be set by the operator of the cold-room who enters the initial condition at the check-in. Degradation is predicted from this point onwards. Furthermore, the mobile application can provide market data where available to the small holder farmer who can take a decision of where and when to sell a crop at which price.

The usage of a digital interface for the room operator has proven to be very effective in reducing OPEX, increasing transparency, increasing operational efficiency, and improving the quality of the storage with less food spoilage. These systems are also proven to be effective in scaling up the business, enabling the management of produce for a larger number of smallholder farmers and connecting them to markets more effectively.

7.10 Maintenance of the cold room

The refrigeration unit must be properly maintained after installation. Preventive maintenance should be scheduled with a qualified refrigeration technician to ensure efficient running and avoid unexpected failures. Staff should be adequately trained and confident with the plant and its control system. The maintenance tasks required vary by type of equipment and the most important advice is to ensure that the supplier provides a maintenance schedule that is suited to the equipment. Repairs of any damage should be made quickly to ensure that users respect the equipment – make sure that staff and users know how to report faults, breakage and damage. The advice below is widely applicable as the basis for planning maintenance and for discussion with suppliers if necessary. Not all items are relevant to every system and more detail will have to be included in the training of staff to implement this – discuss this with your supplier.

7.10.1 A generic maintenance checklist: weekly

- Listen to the equipment when it is running: ears are sensitive and cheap fault monitors, not just to hear alarms. Listen regularly and get familiar with how the equipment should sound. Are fans and the compressor running smoothly? Are the sounds normal also during start up and stopping? Report or investigate if not.
- Check refrigerant leakage.
- Check temperature and relative humidity records for anomalies and drift that could indicate refrigeration system faults (including refrigerant leakage).
- Check the operation of door latches and smooth closing; also for freely opening from the inside (safety check).
- Check the door seals for damage or failure to seal properly (to avoid air leakage, especially in hot humid weather – this causes evaporators to ice up and increase defrosts).

- Check for inside condensation that could indicate door seal problems or poor door management.
- Check that the vacuum relief port is functioning (relieving over-pressure or under-pressure in the room).
- Check the function of alarms.
- Clean condenser coils.
- If solar is included, clean solar modules when dust and dirt start to obscure the surfaces – flat mounted solar arrays will require regular cleaning even in climates with regular rain (see Subsection 5.3.1).
- If solar is included, check for solar array shading, trim vegetation as needed (see Subsection 5.3.1).
- If batteries are included check battery volt meter and/or indicator lights for battery status.

7.10.2 A generic maintenance checklist: three or six monthly

- Clean the produce storage areas thoroughly.
- Check evaporator drain is clear of blockage.
- Check that the drain heater operates (if fitted).
- Check maintenance logs and temperature records for anomalies.
- Have a thorough check carried out on all functions of the refrigeration system.
- Clean condenser coils to ensure free airflow (dirt clogging a condenser leads to a higher condensing temperature and loss of capacity, and every 1°C rise in condensing temperature equates to between 3% and 5% more energy being consumed by the compressors).
- Check calibration of sensors, in particular temperature sensors for monitoring air and produce condition.
- Check fan operation.
- Check and verify the operation of all electrical functions such as lights, alarms, etc.
- Check the inner wall surface for warm areas (heat leaks), perhaps using an infrared spot thermometer (such as non-contact thermometers used for covid checks of face temperature). Humid conditions outside can enable spotting thermal bridges and flaws in insulation by looking for particular areas of condensation on the outer wall surfaces, e.g. in the evenings.
- If batteries are included, follow maintenance instructions (e.g. flooded lead acid batteries will require checking liquid electrolyte levels and if low distilled water is to be added).
- If inverter(s) are included, there may be simple air filter maintenance.
- Check the inventory of crates and shelving that it is still sufficient and repair any damage.
- Check if any significant pruning of trees or bushes is needed to reduce shading of solar arrays (this can be assessed by eye to an extent, but full day checks with instrumentation or app-based analysis may be worth considering, see Subsection 5.3.1).

7.10.3 Calibration of temperature sensors

Calibration of temperature sensors can be carried out quickly and simply, ideally by two persons: one stirring the ice water mix and sensors, the other controlling the sensor readings:

1. Prepare melting ice water in an insulated can or container. The container should have broken up ice and sufficient water for the ice to float; stir the ice water thoroughly and continuously. This mixture will be exactly 0.0°C.
2. Place the sensor or thermometer in the mixture, ensuring that the sensor is not in direct contact with the ice or the wall of the container.
3. If the temperature offset from zero is more than 0.5°C, the sensor should be replaced with a new one (check the new one too) or reset by the supplier if that option is available.
4. The result of calibration testing should be registered in the logbook, before and after any reset adjustment (offset change) with the date and name of the technician.

7.11 Operational budgeting for the cold room

The total construction and operating costs for refrigerated systems vary widely depending on the capacity, costs of local materials, labour and electricity. The Return on Investment (RoI) depends largely on the market value of the produce being stored and how efficiently the facility is used. Therefore, operational management and monitoring are crucial to the viability of the cold room as a business.

The efficiency of operation must consider the percentage of total capacity utilised over time and the number of days per year the facility is in operation. Energy requirements of a cold room could range from 2 to 11 Wh per kg of stored produce per day for small-scale operations to as little as 1 Wh per kg per day for large-scale (semi-industrial) operations. This wide range of energy use results from variations in storage volumes, target temperatures, ambient temperature differences and initial produce temperature over the course of a typical day and season. This section examines contributory factors to optimising efficiency.

7.11.1 OPEX budget for running the cold room

The ongoing costs to run a cold room might include any or all of those listed below and more. Budgeting must take account of which costs are constant and inevitable regardless of what is happening in the cold room, and which will vary based on activity level, for example, during quiet or empty times for the cold room. The budget for maintenance is addressed separately in 7.11.2.

- Operational cost of energy and upkeep of the battery if included, taking account of, including how this varies based on storage temperature, time of year, time of day, weather (for solar and renewable sources) and how busy the cold room is.
- Cost of financing (loans for equipment and other costs).
- Salary and other payments for workers on the site, both permanent and temporary; consider technical, management and security staff.
- Rent for the site or land on which the cold room is located.
- Monthly fees for any Internet services for system remote monitoring, upload and storage of data, access to weather and produce market price data.
- Lease or hire of any specialist equipment needed for running the cold room (e.g. back-up generator, handling or cleaning equipment).

- Costs associated with building and maintaining 'market linkage', i.e. attracting and building relationships with users, facilitating transport links for produce, ensuring sufficient utilisation of the cold room in off-peak times and more.
- Saving funds for development of the cold room hardware, preparing for diversification and expansion.
- Insurance for the cold room facility and equipment.
- Insurance for stored produce.

7.11.2 Budget for maintenance and spare parts

A separate budget should be kept for operational maintenance as this is essential to keep the business viable through running effectively and efficiently and to protect the investment made.

- Costs of consumables, spare parts and any sub-contractor fees for maintenance on weekly, monthly and annual basis (see 7.10). A guideline often used is that around 2% to 5% of the total CAPEX should be considered as an annual investment in maintenance to ensure reliable performance.
- Replacement of battery can be a significant cost.
- Replacing storage crates, shelving and any other packaging that may get lost or damaged during normal use.
- Trimming of vegetation to avoid shade on solar arrays and safe access for staff and vehicles.
- Costs of wear-and-tear and weather-related repairs to the site such as sun shading, signage, vehicle access roadways and parking, lighting, door closure mechanisms, PVC strip curtains in doorways (regularly damaged and important to maintain and clean), temperature sensors and readouts.
- Consumables and equipment for cleaning of the cold room and delivery areas.

7.12 References

Bachmann, J. and Earles, R. 2000. Postharvest handling of fruits and vegetables (pp. 1-19). Ozark Mountains, University of Arkansas, Fayetteville, NC, USA: ATTRA.

El-Ramady, H.R., Domokos-Szabolcsy, É., Abdalla, N.A., Taha, H.S. and Fári, M. 2015. Postharvest management of fruits and vegetables storage. In Sustainable agriculture reviews (pp. 65-152). Springer, Cham.

López Camelo, A.F. Manual for the preparation and sale of fruits and vegetables, from field to market. Rome, 2004. Whole manual accessible as an online book, available at <https://www.fao.org/3/y4893e/y4893e00.htm#Contents>

Krishnakumar, T. 2002. Design of cold storage for fruits and vegetables. Tamil Nadu Agricultural University, pp.1-58.

Motmans T., Evangelista R., Schelle C. Simran, Your Virtual Cold Chain Assistant, The Basel Agency for Sustainable Energy <https://yourvcca.org>

8

Bibliography and references; resources for further guidance

8.

Bibliography and references; resources for further guidance

8.1 Introductory material on walk-in cold rooms and cold chains

- **WICR Solar Appliance Technology Brief, Efficiency for Access, 2021.**
Available from: https://efficiencyforaccess.org/wp-content/uploads/EforA_Solar_Technology_Brief_WalkInColdRooms_July-2021.pdf
- **Life cycle greenhouse gas emissions assessment of off- and weak-grid refrigeration technologies, April 2023,** Efficiency for Access.
Available from: <https://efficiencyforaccess.org/publications/life-cycle-greenhouse-gas-emissions-assessment-of-off-and-weak-grid-refrigeration-technologies>
- **The Role of Refrigeration in Worldwide nutrition, 2020,** 6th Informatory Note on Refrigeration and Food, International Institute of Refrigeration.
Available from: <https://doi.org/10.18462/iir.INfood06.03.2020>
- **Promoting Food Security and Safety via Cold Chains. Deutsche Gesellschaft für Internationale Zusammenarbeit (GIZ), 2016.**
Available from: <https://www.green-cooling-initiative.org/news-media/publications/publication-detail/2016/12/01/promoting-food-security-and-safety-via-cold-chains>
- **Use of cold chains for reducing food losses in developing countries** (No. 13-03; PEF White Paper, Issues 13-03). The Postharvest Education Foundation (PEF), **2013.**
Available from: http://postharvest.org/Cold_chains_PEF_White_Paper_13_03.pdf
- **Assessment of the cold chain in India. Efficiency for Access, 2023.**
Available from: <https://storage.googleapis.com/e4a-website-assets/Assessment-of-the-Cold-Chain-Market-in-India.pdf>
- **Assessment of the cold chain in Kenya. Efficiency for Access, 2023.**
Available from: <https://storage.googleapis.com/e4a-website-assets/Assessment-of-the-Cold-Chain-Market-in-Kenya.pdf>
- **Sustainable Food Cold Chains: Opportunities, Challenges and the Way Forward. Nairobi, UNEP and Rome, FAO, 2022.**
Available from: <https://doi.org/10.4060/cc0923en>

8.2 Post-harvest storage of produce and food science

- **Small-Scale Postharvest Handling Practices: A Manual for Horticultural Crops (5th Edition, 2015).** University of California, Davis.
Available from: <https://postharvest.ucdavis.edu/publication/small-scale-postharvest-handling-practices-manual-horticultural-crops-5th-edition>
- **Manual for the preparation and sale of fruits and vegetables, from field to market, Food and Agriculture Organization of the United Nations, Rome, 2004.**
Accessible as an online book at <https://www.fao.org/3/y4893e/y4893e00.htm#Contents>
- **Postharvest precooling of fruit and vegetables: A review. Trends in Food Science & Technology, 100, 278–291, 2020.**
Available from: <https://doi.org/10.1016/j.tifs.2020.04.027>
- **Compatibility chart for fruits and vegetables in short-term transport or storage Division of Agriculture and Natural Resources, 1996.**
Available from: https://postharvest.ucdavis.edu/Commodity_Resources/Storage_Recommendations/Compatibility_Chart_for_Short-term_Transport_or_Storage

8.3 Refrigeration hardware, design and installation advice

- **Environmentally and climate-friendly solar-powered walk-in cold rooms: Technical guidelines, Green Cooling Initiative (GCI) / Proklima; Water and Energy for Food (WE4F), 2022.**
Available from: https://www.green-cooling-initiative.org/fileadmin/user_upload/220509_WE4F_broschure_cold_rooms_Compress.pdf
 - These technical guidelines explain important ways to minimize the environmental and climate impacts of solar walk-in cold rooms. Covered, are: solar PV panels and inverters, compressors, refrigerants, insulating foam blowing agents, batteries, recycling and management of materials at end of life.
- **Energy Efficiency in Cold Rooms, Design Application manual DA12, Australian Institute of Refrigeration, Air Conditioning and Heating, May 2020.**
Available from: https://airah.org.au/site/iCore/Store/StoreLayouts/Item_Detail.aspx?iProductCode=DA12 (fee applies)
 - This design manual is for engineers, refrigeration technicians and contractors, owners, operators and specifiers to help overcome barriers to energy efficiency for small to medium-sized stores. It explains factors affecting efficiency and standard design calculations, with a 'Star Rating Index' to compare energy efficiency of proposed refrigeration solutions.

- **Cold Store Code of Practice (revised 2020)**, UK Institute of Refrigeration.
Available from: <https://ior.org.uk/rachp-publications> (fee applies)
 - The IOR Cold Store Code of Practice is a reference document for cold room designers and intended to assist those responsible for specifying the requirements for a refrigerated cold room within the UK. It outlines all design elements of a modern cold room and covers the specification, construction, refrigeration plant. The Code is not intended for cold rooms smaller than 30m³.
- **Precooling systems for small-scale producers, Lisa Kitinoja and James F Thompson, Stewart Postharvest Review v. 6, n. 2 (01 June 2010)** : 1-14, ISSN_17459656.
Accessed 16.8.2023 at <https://access.portico.org/stable?au=phx64r6d413>
 - This technical paper identifies precooling systems and cooling methods that are suitable for smaller scale horticultural producers. It assembles evidence, quantitative analysis and practical examples of solutions for precooling before cold storage.
- **Heat load and cooling load estimation aids:**
 - Tools are made available on the websites of some manufacturers to help calculate the required cooling capacity for a cold room. For example, the Danfoss online specification tool, available at: <https://coolselectoronline.danfoss.com>.
- **Installation: EN 16855-2 Walk-in cold rooms - Definition, thermal insulation performance and test methods, Part 2: Customized cold rooms, Annex D Guide on Installation**
 - The Annex D is around 16 pages and covers tools, installation of panels, floor, doors and windows, types of joints, vapour sealing, installing pressure relief valves, maintenance, cleaning and more.
 - **Note:** Part 1 of EN 16855 covers Prefabricated Cold Room Kits and contains an Annex D Guide on Installation which is similar in size and depth but adapted for cold room kits.

8.4 Solar photovoltaic and electrical systems

- **WHO/UNICEF, Introducing Solar-Powered Vaccine Refrigerator and Freezer Systems, Geneva, Switzerland, 2015.**
Available at https://apps.who.int/iris/bitstream/handle/10665/195778/9789241509862_eng.pdf?sequence=1
- **A Practical Guide to Solar Photovoltaic Systems for Technicians, Sizing, Installation and Maintenance, Jean-Paul Louineau, 2020.**
Available from: <https://practicalactionpublishing.com/book/2482/a-practical-guide-to-solar-photovoltaic-systems-for-technicians>
- **IEEE 1562 (2021).** Recommended Practice for Sizing of Stand-Alone Photovoltaic (PV) Systems.
Available from: <https://ieeexplore.ieee.org/document/9528316>
- **Off-Grid PV Systems: Design and Installation (Global Sustainable Energy Solutions), 2022.**
Available from: <https://www.gsesinternational.com/product/off-grid-pv-systems-design-installation-ebook>
- **Energypedia Solar Portal,**
accessible at: <https://energypedia.info/wiki/Portal:Solar>

8.5 Business planning and financing

- **Postharvest Assessment Methodology: conceptual framework for a methodology to assess food systems and value chains in the postharvest handling of perishables as a basis for effective interventions, 2022.** Report 2359 / Wageningen Food & Biobased Research.
Available from: <https://doi.org/10.18174/582556>
- **Financing Access to Cooling Solutions (Knowledge Brief), Sustainable Energy for All, 2020.**
<https://www.seforall.org/data-and-evidence/financing-access-to-cooling-solutions>

8.6 International technical standards, quality frameworks and product testing

- **The World Health Organisation (WHO)** has set up an extensive quality assurance programme for equipment used to implement immunisation programmes under its Performance, Quality and Safety (PQS) process. The equipment under this scheme is for medical and immunisation applications but has technology and principles in common with equipment for storage of foodstuff. The WHO PQS product and equipment specifications and assessment protocols related to cold rooms are available here:
https://apps.who.int/immunization_standards/vaccine_quality/pqs_catalogue/catdocumentation.aspx?id_cat=15
- **European Standard EN 16855 Walk-in cold rooms - Definition, thermal insulation performance and test methods** – Part 1 Prefabricated Cold Room Kits; and Part 2: Customized cold rooms. **Note:** These standards define only a calculation method and not a practical test; they include good practice advice on cold room installation (Annex D).
- **Indian Standard IS 2370:2014 Walk-in Cold Rooms – Specification.** Defines a lab test method for walk-in cold rooms to determine thermal transmittance of the insulated envelope; air flow; capacity rating; power consumption and maximum operating condition.
- **IEC TS 62257-100:2022 Renewable energy off-grid systems** - Part 100: Overview of the IEC 62257 series. This is an overview of the IEC 62257 series of standards for setting up off-grid electrification.
Available from: <https://webstore.iec.ch/publication/64175>
- **Field Testing of Appliances Suitable for Off- and Weak-Grid Use, Generic guidance on appliance performance monitoring in the field, January 2022,** Efficiency for Access coalition.
Available from: <https://efficiencyforaccess.org/publications/field-testing-of-appliances-suitable-for-off-and-weak-grid-use>

8.7 Sourcing of hardware

- **2022 Buyer's Guide for Off-Grid Cold Chain Solutions, Efficiency for Access.**
Available from: <https://staging.efficiencyforaccess.org/publications/2022-buyers-guide-for-off-grid-cold-chain-solutions>
- **Productive Use Catalogue 2023**, African solar industry Association (includes a section on cold storage).
Available from: <http://afsiasolar.com/data-center/pue-catalog-2023>

8.8 Passive cooling approaches (zero or low energy)

- **Evaporative Cooling Best Practices Guide, Eric Verploegen, Peter Rinker, Kukom Edoh Ognakossan, MIT D-Lab, Jun 2018.**
Available from: <http://d-lab.mit.edu/resources/publications/evaporative-cooling-best-practices-guide>
- **A Guide to Assembling, Using, and Maintaining Clay Pot Coolers, Eric Verploegen, Melissa Mangino, Kukom Edoh Ognakossan, Aly Ahamadou, and Fatimata Cissé, Apr 02, 2021.**
Available from: <https://d-lab.mit.edu/resources/publications/guide-assembling-using-and-maintaining-clay-pot-coolers>
- **Forced-air evaporative cooling chamber at low cost for hot and dry climates**, with detailed design documentation, from D-Lab at MIT:
<https://www.cooling-chamber.mit.edu>

8.9 Further resource lists for post-harvest and cooling technologies

- **Efficiency for Access:** [Access to cooling publications](#)
- **SEforAll:** [Access to Cooling initiatives](#)
- **ESMAP:** [Efficient and clean cooling resources](#)
- **Energypedia:** [Cold storage for agricultural produce](#)
- **The Postharvest Education Foundation (PEF) White Papers:**
https://www.esmap.org/esmap_Efficient_Clean_Cooling_Program_Profile



TERMINOLOGY USED IN THIS GUIDE	222
GLOSSARY	223
ACRONYMS, ABBREVIATIONS	227

Terminology

used in this guide

Aggregator Entity that buys produce from various farmers and sells them in bulk

Developer A person or company that develops the idea of the cold store

Grid Network to supply electrical power to users. See 3.6.1 and 5.2.1 for more detailed definitions.

- Reliable grid: electrical supply with sufficient quality of voltage and frequency and continuity of supply that the cold room can be operated reliably
- Limited supply grid: electrical supply of reasonable or good quality but operating hours of less than 24 per day
- Unreliable grid: electrical supply available but power is subject to highly variable quality and reliability often without prior notice
- Off grid: no electrical grid is available at the site

Market vendor Who sells agricultural produce in market, including farmers

Operator Commercial entity operating the cold room

Supplier Economical operator who supplies components or the entire system of the WICR

Glossary

Array

Two or more PV (solar electric) modules mechanically and electrically connected to generate a single electrical output

Autonomy

Amount of time that a system (with or without energy storage) can sustain acceptable food storage temperature with no additional electricity input

Availability

Daily average hours that electricity is reliably supplied

Battery

A chemical energy storage device for DC electricity

- Battery (flooded) – a battery with a liquid electrolyte. A flooded lead acid battery has an electrolyte of liquid sulphuric acid
- Battery (lead acid) – a family of rechargeable battery types that use positive and negative charged plates (electrodes) of lead alloy submerged in a conductive sulphuric acid electrolyte
- Battery (lithium ion) – a family of rechargeable batteries where lithium ions move between electrodes through an electrolyte

Blowing agent

Substance used to promote a foaming process and produce a cellular structure in materials that undergo hardening, to reduce their thermal conductivity if used as insulating panels

Cell

(battery) The smallest unit of a battery. Lead acid battery cells are 2 volts each

- (PV, solar) The smallest unit of a solar module when wired together to make a PV module

Chilling

Process of cooling a substance to a temperature above its freezing point (without freezing it)

Cold room

An insulated structure served by a refrigerating unit to maintain product at its storage temperature

- Walk-in cold room: cold room with at least one door that is large enough for a person to walk into

Condenser

Heat exchanger used to release heat from a refrigerating unit

Cooling

Removal of heat, usually resulting in a lower temperature and/or phase change

- Cooling capacity: the amount of cooling per unit time that a refrigerating unit can exploit
- Cooling rate: the decrease in temperature in unit time
- Cooling coil: heat exchanger designed to cool air, which can be used as a direct expansion evaporator or fed with chilled water or secondary fluid

Cycle	(battery) - one battery charge and discharge action
Defrosting	Elimination of frost deposit from the surface of a cooling unit
Depth of discharge	Amount of energy (%) removed from a battery compared to a fully charged battery
Design month	(PV, solar electric): month with a combination of solar insolation and electric load that results in the largest PV (solar electric) array to meet load requirements
Discharge rate	Battery capacity (Ah) discharged over a specific period of time expressed as C/x hours
Electrolyte	Electrically conductive medium in which the flow of electrons occurs. In lead acid batteries the electrolyte is often a liquid of sulphuric acid and water
Evaporator	Heat exchanger used to cool the refrigerated space / fluid by means of a refrigerating unit
First mile	Transfer of goods from a supplier to a warehouse or distribution center. First link in the supply chain
Half cooling time	Time taken to decrease the pulp (or other produce) temperature halfway between the initial temperature and the target temperature
Hybrid electrical supply	Combination of two or more energy sources
Hydrocooling	Cooling of produce (generally vegetable or fruit) by direct contact with chilled water
Interconnects	Electrical wiring (cabling) used to connect single PV (solar electric) modules or batteries into larger groupings (e.g., PV arrays, battery banks)
Insolation	The solar radiation on an area over time
Insulating material	A material having low thermal conductivity
Insulation, thermal insulation	The process of affixing panels of insulating materials to an existing structure, to reduce its thermal transmittance (or increase its thermal resistance)

Inverter Electronic device to change Direct Current DC to Alternating Current AC

Load Amount of energy per unit time

- Electrical load: electrical power needed by an electrical device
- Heat load: heat supplied accidentally to the refrigerated space
- Cooling load: heat to be removed from the refrigerated space to face its heat loads and maintain the desired conditions

Module (PV, solar electric) a single complete assembly of PV cells with protective glazing (usually glass) and output terminals or cables

Outage Whenever electricity supply is unavailable

Overcurrent protection A means of interrupting current flow that exceeds a predetermined design level. Commonly fuses or circuit breakers are used

Photovoltaics Direct conversion of solar radiation to electricity

Precooling Rapid cooling of produce before transport or before transfer to a refrigerated store

Radiative forcing Measure of the change in energy flux in the atmosphere. Positive radiative forcing means Earth receives more incoming energy from sunlight than it radiates to space which will cause warming; negative radiative forcing produces cooling

Refrigerant Fluid used for heat transfer in a refrigerating unit, which absorbs heat at a low temperature and a low pressure of the fluid and rejects heat at a higher temperature and a higher pressure of the fluid, usually involving changes of the state of the fluid

Refrigerating system, refrigerating unit (for vapour compression systems) System that, in operation between a heat source (evaporator) and a heat sink (condenser) at two different temperatures, absorbs heat from the heat source at the lower temperature and rejects heat to the heat sink at the higher temperature. The unit assembly is composed of a compressor, evaporator, condenser, and expansion device

- Direct expansion refrigerating unit: the refrigerant is piped to the cooler unit in the cold room
- Indirect expansion refrigerating unit: brine or another secondary fluid carries the cooling capacity to the cooler unit in the cold room

Refrigeration Cooling of a space, substance or system to lower and/or maintain its temperature below the ambient one (removed heat is rejected at a higher temperature)

Regulator	(also named charge control) common name for a voltage regulator within a solar battery recharging system
Respiration rate	In plants, the volume of oxygen absorbed or carbon dioxide given off by unit mass in unit time
Ripening	With vegetable produce, all biochemical transformations leading to optimum product quality for the consumer
Secondary refrigerant (fluid)	Any fluid employed for transferring heat from the substance to be cooled to the evaporator of the refrigerating unit
Set point temperature	Temperature value to which an automatic control must be pre-set in order that a desired storage temperature be achieved
Solar system	System able to capture and convert solar energy <ul style="list-style-type: none">• Active solar – solar energy applications that require additional energy input and devices (solar heating requiring an electrically driven pump)• Passive (solar energy) - application where no added energy input is required for electrical or mechanical device required (e.g., daylighting of a building)
State of charge	Amount of energy (%) available in a battery
Storage temperature	Lowest safe storage temperature is the lowest possible temperature at which the produce can be stored without causing any adverse effects on its quality <ul style="list-style-type: none">• Set point temperature: the value to which the automatic temperature controller of the cold room must be pre-set in order that the storage temperature be achieved
Surge, Starting surge	Surge current that momentarily occurs when most type of conventional electric motor are started
Surge capacity	Ability of a generator or an inverter to deliver high currents momentarily required to start certain loads (e.g., motor)
Thermal resistance	The reciprocal of thermal transmittance
Thermal transmittance	Heat transferred through unit area of a surface in unit time per unit temperature difference
Tilt angle	Angle (degrees) of PV array as referenced to the horizontal

Acronyms, abbreviations

AC	Alternating current
°C	Celsius degrees
CAPEX	Capital equipment and installation expenses
CFC	ChloroFluoroCarbon refrigerant
COP	Coefficient of Performance of a refrigerating unit: cooling capacity/electrical load
DC	Direct current
FPO	Farmer Producer Organizations - providing support and services to small farmers
GHG	Greenhouse Gas
GWP	Global Warming Potential
HCFC	HydroChloroFluoroCarbon refrigerant
HFC	HydroFluoroCarbon refrigerant
HFO	HydroFluoroOlefin refrigerant
LCA	Life Cycle Assessment
LCC	Life Cycle Cost
ODP	Ozone Depletion Potential
OPEX	Operational expenses
ODS	Ozone Depleting Substances
PCM	Phase Change Material for TES
PV	Photovoltaic
RH	Relative humidity
TES	Thermal Energy Storage
SDD	Solar Direct Drive
SME	Small and Medium-sized Enterprise
VP	Water vapour pressure
WICR	Walk-in cold room

When available, definitions are taken or adapted from the IIF/IIR International Dictionary of Refrigeration (<https://iifir.org/en/international-dictionary-of-refrigeration>) and from the ASHRAE Terminology (<https://terminology.ashrae.org>)



INSTITUT INTERNATIONAL DU FROID
INTERNATIONAL INSTITUTE OF REFRIGERATION

Contact:
www.iifiir.org



Contact:
www.encyforaccess.org