



Global
Green Growth
Institute

Strategies for Development of Green Energy Systems in Mongolia

Final Report

Mongolia Country Program

March 2014



Table of Contents

Executive Summary	11
PART I. INTRODUCTION TO MONGOLIA ENERGY SCENARIOS	
1 Background	21
2 Mongolia’s Energy System: Overview and Challenges	21
3 Report goals and Objectives	25
PART II. SCENARIO DETAILS AND RESULTS, BY SECTOR	
4 Overview of Scenarios and Methodology	26
4.1 Scenarios analyzed	26
4.2 Methodological approach	29
4.3 Energy scenario analysis in the context of green growth	31
5 Power and Heat Supply	32
5.1 Sector Overview	32
5.2 Reference scenario	32
5.3 Recent plans scenario	36
5.4 Expanded green energy scenario	38
5.5 Shift in energy export scenario	43
5.6 Discussion and possible initiatives	47
6 Buildings	50
6.1 Sector Overview	50
6.2 Reference scenario	51
6.3 Recent plans scenario	53
6.4 Expanded green energy scenario	53
6.5 Discussion and possible initiatives	57
7 Transport	58
7.1 Sector Overview	58
7.2 Reference scenario	59
7.3 Recent plans scenario	60
7.4 Expanded green energy scenario	60
7.5 Discussion and possible initiatives	63

8	Industry: Mining and Manufacturing	66
8.1	Sector overview	66
8.2	Reference scenario	67
8.3	Recent plans scenario	71
8.4	Expanded green energy scenario	71
8.5	Shifts in energy export scenario	73
8.6	Discussion and possible initiatives	74
9	Agriculture	75
9.1	Sector overview	75
9.2	Reference scenario	76
9.3	Expanded green energy scenario	78
9.4	Discussion and possible initiatives	78
PART III. OVERALL RESULTS, CONCLUSIONS, AND NEXT STEPS		
10	Overall Scenario Results	80
10.1	Electricity generation	81
10.2	Energy demand	81
10.3	Greenhouse gas emissions	85
10.4	Other pollutant emissions	90
10.5	Cost-effectiveness analysis	92
11	Conclusions and Next Steps	95
11.1	Summary of overall findings	95
11.2	Policies for consideration	97
11.3	Potential “next steps” for green energy development: projects, pilots, and further research	98
	Data gathering	98
	Capacity building	99
	Pilot programs	100
	Research	100
12	References Cited	104
Appendix A: Listing of the Members of the Project Advisory Committee		110
Appendix B: Approaches to accounting for GHG emissions		111
Appendix C: Possible Green Growth Indicators for Mongolia		118

Appendix D. Ministries and Agencies Responsible for Renewable Energy in Mongolia	122
Appendix E: Listing of LEAP Scenarios in Mongolia Data Set	123
Appendix F: Summary Description of LEAP Software Tool	129

List of Tables

Table 2-2. Primary Energy Production in Mongolia, 1990-2010, TJ ²	24
Table 4-1. Overview of Four Scenarios	28
Table 8-1. Key Drivers, Industry Sector	67
Table 10-2. Electricity output in the reference recent plans, and expanded green energy scenarios, TWh	81

List of Figures

Figure 2-1. Historical electricity generation, by fuel.....	22
Figure 5-2. Electricity generation in the <i>reference scenario</i>	35
Figure 5-3. District heat demand in the <i>reference scenario</i>	35
Figure 5-4. Electricity generation capacity in the <i>recent plans scenario</i>	37
Figure 5-5. Electricity generation in the <i>recent plans scenario</i>	38
Figure 5-6. Electricity capacity in the <i>expanded green energy scenario</i>	42
Figure 5-7. Electricity generation in the <i>expanded green energy scenario</i>	42
Figure 5-8. District heat demand in the <i>expanded green energy scenario</i>	43
Figure 5-9. Electricity capacity in the <i>shift in energy export scenario</i>	46
Figure 5-10. Electricity generation in the <i>shift in energy export scenario</i>	47
Figure 6-1. Energy demand in the buildings sector in the <i>reference scenario</i>	52
Figure 6-2. Energy demand in the buildings sector in the <i>recent plans scenario</i>	53
Figure 6-3. Energy demand in the buildings sector in the <i>expanded green energy scenario</i>	55
Figure 7-1. Energy demand in the transport sector in the <i>reference scenario</i>	60
Figure 7-2. Energy demand by vehicle type in the transport sector in the <i>expanded green energy scenario</i>	62
Figure 8-1. Energy demand by subsector type in the industrial sector, <i>reference scenario</i> .	70
Figure 8-2. Energy demand by fuel in the Industrial sector, <i>reference scenario</i>	70
Figure 8-3. Energy demand by subsector type in the industrial sector, <i>expanded green energy scenario</i>	72
Figure 8-4. Energy demand by fuel in the industrial sector, <i>expanded green energy scenario</i>	73
Figure 9-2. Energy demand by fuel type in the agriculture sector, <i>reference scenario</i>	77
Figure 10-2. Overall energy demand by fuel group, <i>recent plans scenario</i>	82
Figure 10-3. Overall energy demand by fuel group, <i>expanded green energy scenario</i>	83
Figure 10-4. Electricity demand by sector, <i>reference scenario</i>	84
Figure 10-5. Electricity demand by sector, <i>recent plans scenario</i>	84
Figure 10-6. Electricity demand by sector, <i>expanded green energy scenario</i>	85

Figure 10-7. GHG emissions by sector, <i>reference</i> scenario	86
Figure 10-8. GHG emissions by fuel, <i>reference</i> scenario	86
Figure 10-9. GHG emissions by sector, <i>recent plans</i> scenario	87
Figure 10-10. GHG emissions by fuel, <i>recent plans</i> scenario	87
Figure 10-11. GHG emissions by sector, <i>expanded green energy</i> scenario.....	88
Figure 10-12. GHG emissions by fuel, <i>expanded green energy</i> scenario	88
Figure 10-13. Extraction-based emissions under the <i>shift in energy exports</i> scenario, relative to the <i>reference scenario</i>	90
Figure 10-14. Sulfur Oxide Emissions under Three Scenarios	91
Figure 10-15. Nitrogen Oxide Emissions under Three Scenarios.....	91
Figure 10-16. “Cost Curve” showing GHG savings and cost per tonne of CO ₂ e reduced in 2035.....	94

List of Abbreviations

ADB – Asian Development Bank

CCS – Carbon Capture and Storage

CES – Central Energy System

CHP – Combined Heat and Power

CH₄ – Methane

CNG – Compressed Natural Gas

CO₂ – Carbon Dioxide

GDP – Gross Domestic Product

GEF – Global Environmental Facility

Gg – Gigagram

GGGI - The Global Green Growth Institute

GHG – Greenhouse Gas

Gcal – Gigacalories (10⁹ calories)

GJ – Gigajoules (10⁹ Joules)

GSHP – Ground-source Heat Pumps

GTI – Greater Tumen Initiative

GW – Kilowatts (billion Watts)

GWh – Gigawatt-hours (10⁹ Watt-hours)

GWP – Global Warming Potential

HOB – Heat-only Boilers

IEA – International Energy Agency

IMF – International Monetary Fund

IPCC – Intergovernmental Panel on Climate Change

kcal – Kilocalories

kg – Kilograms

kW – Kilowatts (thousand Watts)

kWh – Kilowatt-hours (10³ Watt-hours)

LPG – Liquefied Petroleum Gas

LEAP – Long Range Energy Alternatives Planning software tool

MEGD – Mongolian Ministry of Environment and Green Development

MOE – Mongolian Ministry of Energy

MW – Megawatts (million Watts)

MWh – Megawatt-hours (10^6 Watt-hours)

NGO – non-government organization

NO_x – Nitrogen Oxides

O&M – Operating and Maintenance

OECD – Organization for Economic Cooperation and Development

PJ – Petajoules (10^{15} Joules)

pkm – Passenger-kilometers

PM – Particulate Matter

PM_{2.5} – Particulate Matter under 2.5 micrometers in diameter

PV – Photovoltaic (solar)

SEI-US – Stockholm Environment Institute—US

SO_x – Sulfur Oxides

SWH – Solar Water Heating

T&D – Transmission and Distribution

TCE – Tonnes of Coal Equivalent

TCO_{2e} – Tonnes of CO₂ Equivalent

TJ – Terajoules (10^{12} Joules)

tkm – Tonne-kilometers

TWh – Terawatt-hours (10^{12} Watt-hours)

TOE – Tonnes of Oil Equivalent

UB – Ulaan Baatar

UN – United Nations

UNDP – United Nations Development Programme

UNEP – United Nations Environment Programme

UNESCAP – United Nations Economic and Social Commission for Asia and the Pacific

UNFCCC – United Nations Framework Convention on Climate Change

USGS – US Geological Survey

Acknowledgments

Special thanks are due to all the members of the project's guidance team: Mr. Tovuudorj Purevjav, Mr. Bekhbat Sodnom, Mr. Angarag Myagmar, Ms. Tsendsuren Batsuuri, Mr. Enebish Namjil, and especially to Mr. Chimeddorj Demchigjav, who served as the key person at the Ministry of Energy. Special thanks are also due to the members of the project's technical team: Mr. Gerelt-od Tsogtbaatar, Ms. Tegshjargal Bumtsend, Mr. Tumenjargal Makhbal, Mr. Atarjargal Tserendoo, Mr. Purevdash Solikhuu, Ms. Gerel Jambaa, Ms. Ariunzul Dashjamts, Ms. Javzanpagma N. , Mr. Misheelt Ganbold, Mr. Enkh-Angalan Davaa-Ochir, and Mr. Enkhsaihan Tumen-Ulzii. Thanks are also due to other officials of the Mongolian government who provided support throughout, though we cannot name them all here.

This report was prepared by the Stockholm Environment Institute – U.S. (SEI-US), in partnership with GGGI and a team of consultants based in Ulaanbaatar. At SEI-US, Dr. David von Hippel was the project manager and lead author of the report. Mr. Peter Erickson, Mr. Michael Lazarus, and Mr. Kevin Tempest contributed to the report and the analysis throughout. Dr. Charlie Heaps at SEI-US provided guidance throughout. The team of local consultants included Dr. Dorjpurev J., Ms. Oyunchimeg Ch., and Mr. Sukhbaatar Ts., and their hard work in providing insights to Mongolia's current and future energy situation, as well as in working with the Advisory Committee in gathering data for this report and in providing logistical assistance to the project, has been extremely important to the project's success.

Executive Summary

Mongolia is a landlocked country in eastern and central Asia, bordered by Russia to the North and China to the South. With an annual average temperature of -3 degrees Celsius, as well as being one of the world's most sparsely populated territories, Mongolia faces considerable challenges to provide sufficient heat and electricity for its people, especially in rural areas, both in terms of power quantity and quality. Its capital, Ulaanbaatar City, is the largest municipality of Mongolia, and is home to over one million people, comprising 45% of the total national population.

Currently, the biggest power plants in the country are aging coal-fired plants providing electricity and, in most cases, district heat via central networks. Many local areas still rely on coal-based heat-only boilers for district heat, and a few smaller cities, towns, and villages are still supplied with electricity from diesel-fuelled units, many of which can provide power for only a few hours per day due to lack of fuel (or funds to purchase fuel) and other restrictions. Mongolia does, however, have a significant potential for development of different types of renewable energy, including solar, wind, and some hydroelectric resources. Solar and wind power, in particular, are widely available across the country.

Mongolia is challenged by its natural environment, its dispersed population, and pollution problems resulting from its legacy of older infrastructure. However, its natural resources, including both renewable resources and mineral resources, its capable workforce, and its excellent relations with its neighbors and the international community render it well-placed to consider and implement renewable energy development. Its challenges are significant, but relative to those of many nations, tractable.

Mongolia is playing an increasing role in providing energy, largely in the form of coal, and, to a lesser extent, crude oil, principally to China. Mongolia's status as a supplier of energy to northeast Asia may expand in the future to Korea and Japan, as more of the country's significant coal and renewable energy resources are harnessed. How Mongolia chooses to develop these resources may have impacts not only on the country's own economy and environment, but also on global climate change.

GGGI's project, Strategies for Development of Green Energy Systems in Mongolia aims to define and describe green energy systems that would reduce GHG emissions, improve air quality, and bring other socio-economic benefits. Launched in 2013, the project has been carried out in conjunction with the U.S. Centre of the Stockholm Environment Institute (SEI-US). This report presents main findings of the project by exploring several different "scenarios" of evolution of the country's energy supply and demand, including in industry, transport, buildings, and agriculture sectors. It is hoped that the findings and recommendations illustrated in the report are useful and informative not only to relevant researchers and development practitioners but also to Mongolian policymakers in their challenging position to balance between economic growth and environmental sustainability.

This study employs a bottom-up techno-economic analysis of energy and GHG-reduction scenarios, which are assembled in the Long-range Energy Alternatives Planning (LEAP) software developed by SEI-US. (The LEAP software tool is widely used in energy policy analysis and climate change mitigation assessment works in more than 190 countries worldwide. A summary description of the LEAP software tool is provided as Appendix F to this Report.) This type of bottom-up analysis is commonly used by countries in their energy and climate change mitigation planning, as well as for in reporting to international bodies such as the United Nations Framework Convention on Climate Change. In a bottom-up analysis, groups of energy-saving and energy-supply measures are combined into the broad scenarios.

An energy scenario is an internally consistent “story” of how energy use, power and heat supply, and the underlying economy, may develop in the future. Scenarios for the project were developed with the input of, and with data collected by, an Advisory Committee of officials from the Ministry of Energy and several other organizations in Mongolia, as well as with inputs from a local consultant team.

This study presents four broad scenarios of how energy supply and demand could evolve in Mongolia through the year 2035. All four scenarios use the same economic and demographic growth forecasts, which draw from recent studies, to determine the need for energy services. In doing so, they all assume rapid growth of Mongolia’s economy, especially in mining and industrial sectors, and with related effects like increasing demand for freight and personal transportation. (Forecasts for key drivers will be presented in the chapter for the corresponding sector.) Given the rapid changes in Mongolia’s economy, the scenarios here are subject to significant uncertainty. The four scenarios were developed over the course of 2013 with input from a project Advisory Committee and others. Following is a brief introduction and description of the four scenarios:

- The *reference* scenario reflects a continuation of largely coal-based energy supply in an economy driven largely by mining exports, especially of coal and copper. This scenario assumes relatively few changes in energy supply or the intensity of demand other than gradual improvements in some technologies (e.g., vehicles, appliances) consistent with international trends likely to evolve regardless of changes in Mongolia’s policies.
- The *recent plans* scenario begins to introduce a shift to renewable energy and increased energy efficiency based on recent plans and priorities of the Ministry of Energy and Ministry of Environment and Green Development: namely, large hydropower plants (e.g., Sheuren) and wind turbines, application of more-efficient pulverized coal combustion technologies, and programs to implement efficient lighting and improved insulation of panel apartment buildings.
- The *expanded green energy scenario* describes a future where Mongolia makes an even stronger transition to renewable energy and implements extensive energy efficiency measures across its economy. This scenario also builds from work on renewable energy and energy

efficiency potentials conducted in the country, including by the work of the Ministry of Energy, the Ministry of Environment and Green Development.

- The *shifts in energy export* scenario builds from the *expanded green energy* scenario; in this scenario, Mongolia shifts the types of fuel and energy that it exports: rather than exporting an increasing amount of coal from Tavan Tolgoi and other deposits, the country instead exports renewable (wind and solar) electricity to a regional grid, in partnership with other countries .

This study finds that, in the reference scenario, total energy demand in Mongolia may rise from less than 150 petajoules (PJ) in 2010 to over 400 PJ in 2035 (Figure ES-1). The reference scenario sees demand for electricity (especially from industry) and oil products (especially from cars and trucks, as diesel and gasoline) grow especially fast – both at over 5 times 2010 levels in 2035.

Figure ES-1. Overall energy demand by fuel group, reference scenario

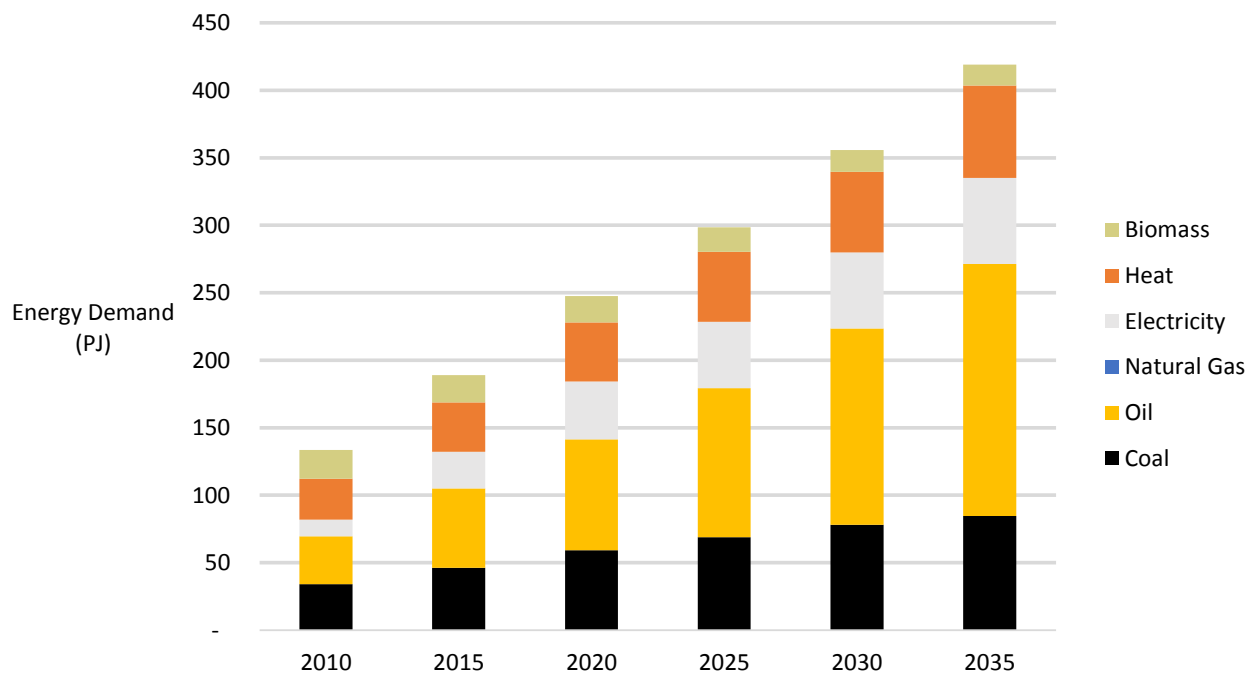

In the recent plans scenario, efforts to retrofit apartment buildings for better energy performance and to increase the efficiency of lighting in homes and businesses reduce demands for electricity and especially heat, leading to modest (6%) reduction in energy demand in 2035 relative to the reference scenario (Figure ES-2).

Figure ES-2. Overall energy demand by fuel group, *recent plans* scenario

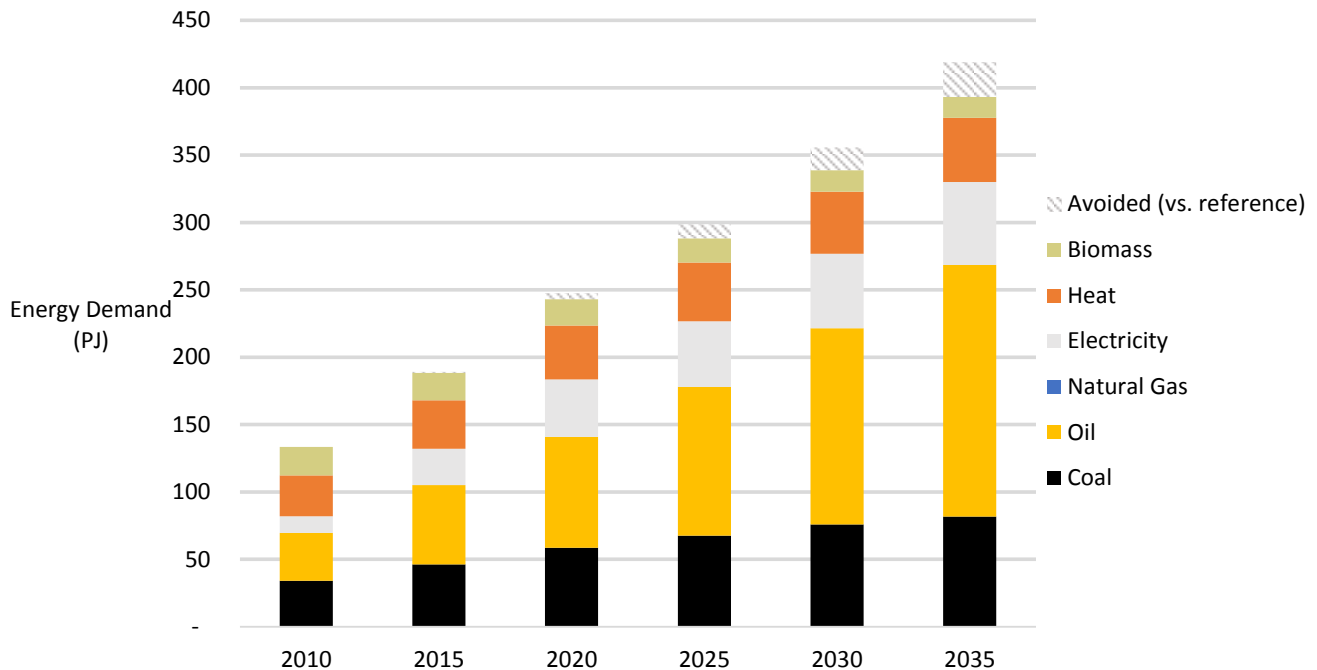

The *expanded green energy* scenario implements deep energy efficiency strategies in all sectors, from best-available technologies in industry to highly efficient vehicles (including hybrids and, over time, electric vehicles) in the transport sector, to highly energy efficient building retrofits, including for gers. Together, these efforts reduce energy demand by 32% relative to the reference scenario in 2035, slowing the average rate of growth of energy use from 4.7% to 3.1% between 2010 and 2035. (The *shift in energy export* scenario differs from the expanded green energy scenario only in what type of energy is exported, and so overall domestic energy demand is similar to that in figure ES-3.)

Figure ES-3. Overall energy demand by fuel group, *expanded green energy scenario*

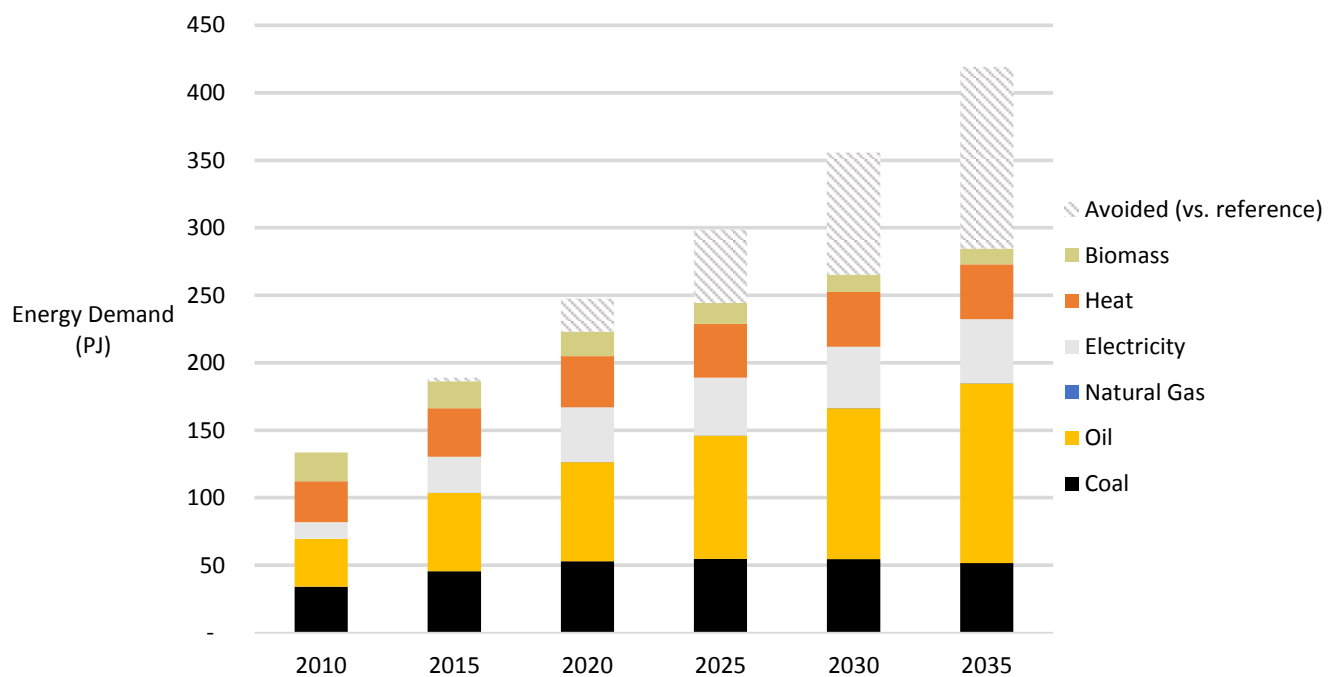

The recent plans and expanded green energy scenarios also see progressively greater penetration of renewable electricity on the supply side. In the reference scenario, coal-fired power plants remain the dominant means of fulfilling new electricity demands, and the fraction of Mongolia’s electricity generation supplied by renewable energy remains under 5% though 2035 (Figure ES-4).

Figure ES-4. Electricity generation in the *reference scenario*

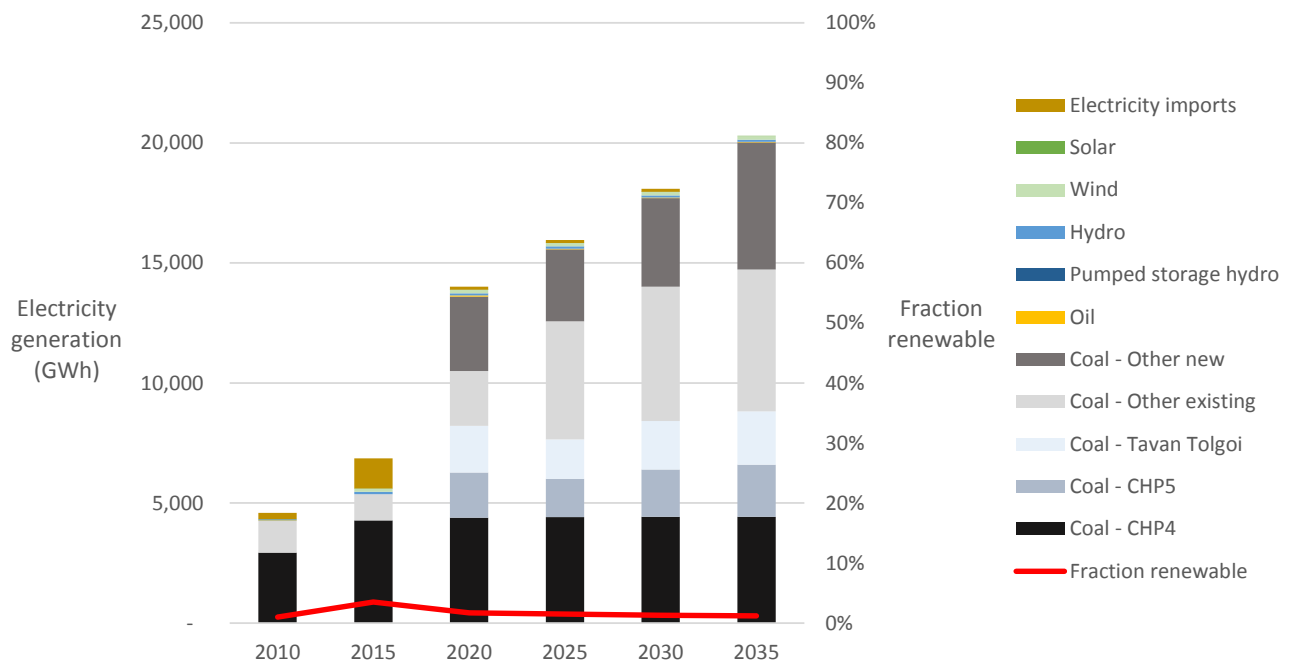

In the recent plans scenario, and following trends outlined in Mongolia’s draft *Energy Sector Masterplan*, expansion of hydroelectricity (such as the Sheuren plan) and, to a lesser extent, wind power, raise the fraction of electricity supplied by renewables to about 15% by 2025 (Figure ES-5).

Figure ES-5. Electricity generation in the *recent plans scenario*

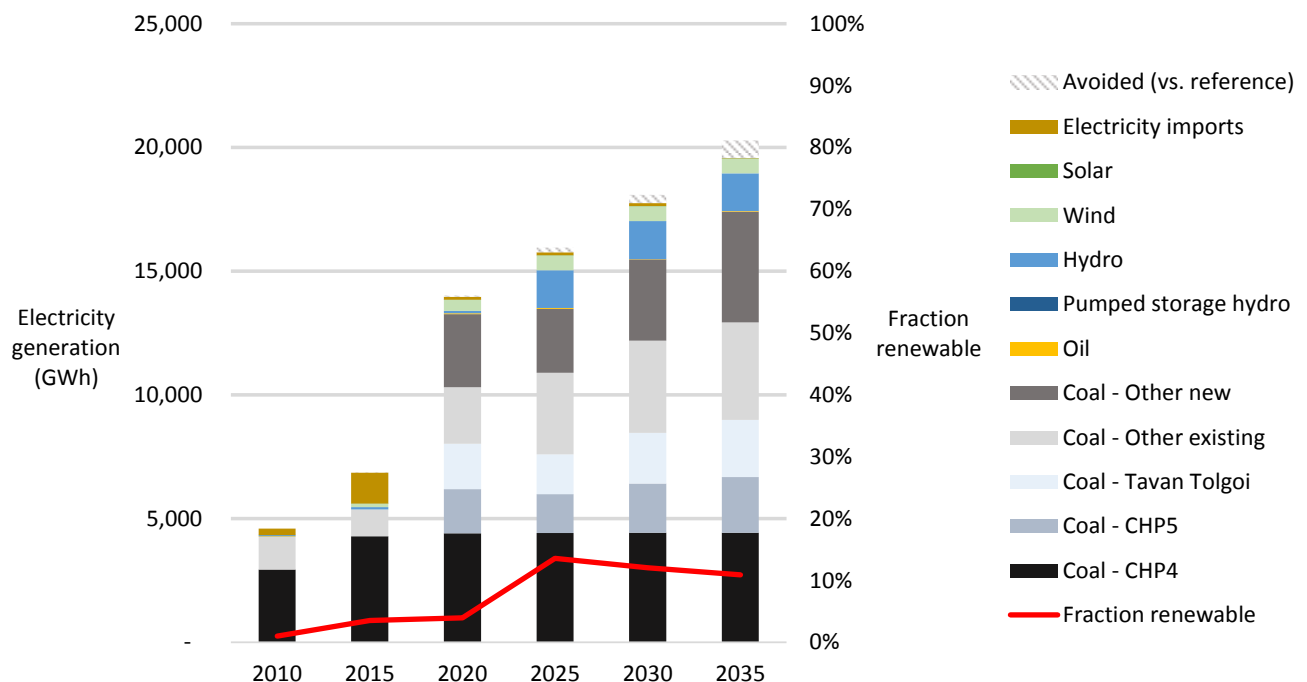

The *expanded green energy* scenario sees all currently proposed hydro (e.g., Sheurn, Elgiin, Orkhontul), solar PV (Sainshand, Khurmen), and wind (e.g. Govisumber, Umnogovi) power projects realized. When combined with the reduction in electricity demand resulting from the extensive energy efficiency measures discussed above, this allows for the avoidance of significant new (and expanded) coal-fired power plants, and for some of the existing, aging plants to be phased down or retired. The fraction of electricity provided by renewable energy in this scenario exceeds 40% as early as 2030. And, though a complete assessment of costs was not possible, this study estimates that the expanded green energy could cost nearly 400 million dollars less than the reference scenario cumulatively through 2035 (on a “net present value”, NPV basis) due to the significant fuel savings associated with energy efficiency.

Figure ES-6. Electricity generation in the *expanded green energy* scenario

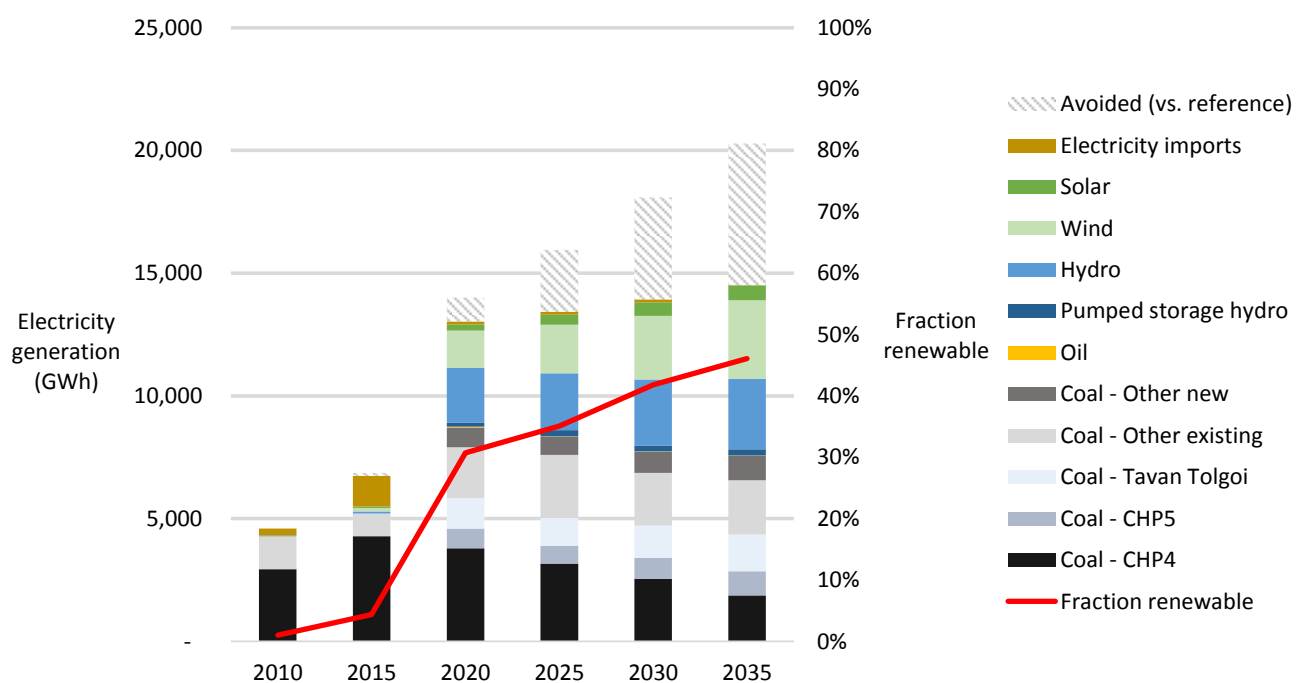

In the fourth, shifts in energy export scenario, Mongolia rapidly builds out solar PV and wind resources in Gobi region, starting with 30 MW in 2017 and then growing with installations growing at an annual rate averaging about 60% (higher in early years, lower in later years), an average rate of renewables expansions that matches China’s over the past two decades. At this level, Mongolia could install nearly 12 GW of renewables in the South Gobi by 2031, displacing a significant fraction (potentially even all) of the value of coal exports by that time, depending on the value of exported electricity and fossil fuels. Exporting this amount of power will require large investments in transmission and distribution facilities, probably with multiple connections to entry points on the

Chinese grid as well as high-voltage direct current (HVDC) lines to other nations, such as Korea and Japan. Though highly ambitious, the shifts in energy export scenario could give Mongolia a significant source of “green growth” and, by substituting exports of fossil fuels for exports of renewable electricity, increase the country’s “low-carbon competitiveness”, should global demand for fossil fuels begin to decline based on concerns by major economies (including China) regarding climate change.

This study also quantified the potential to reduce greenhouse gas (GHG) emissions in the Mongolia. Implementing all measures studied, as in the expanded green energy scenario, could reduce GHG emissions by 28 million tonnes CO₂e in 2035, or nearly 50% compared to the reference scenario, and holding GHG emissions essentially constant after 2020 case (Figure ES-7). (Implementing the measures in the *recent plans* scenario would reduce GHG emissions by 7 million tonnes CO₂e in 2035, or 12% compared to the reference scenario.)

Figure ES-7. GHG emissions by sector, *expanded green energy scenario*

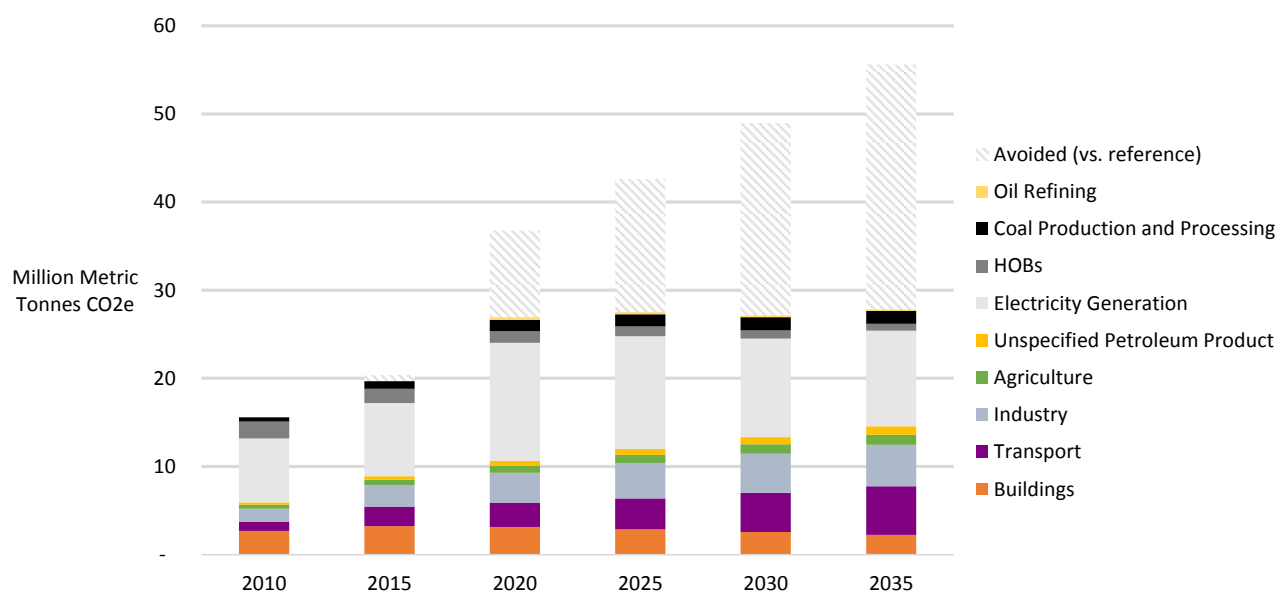
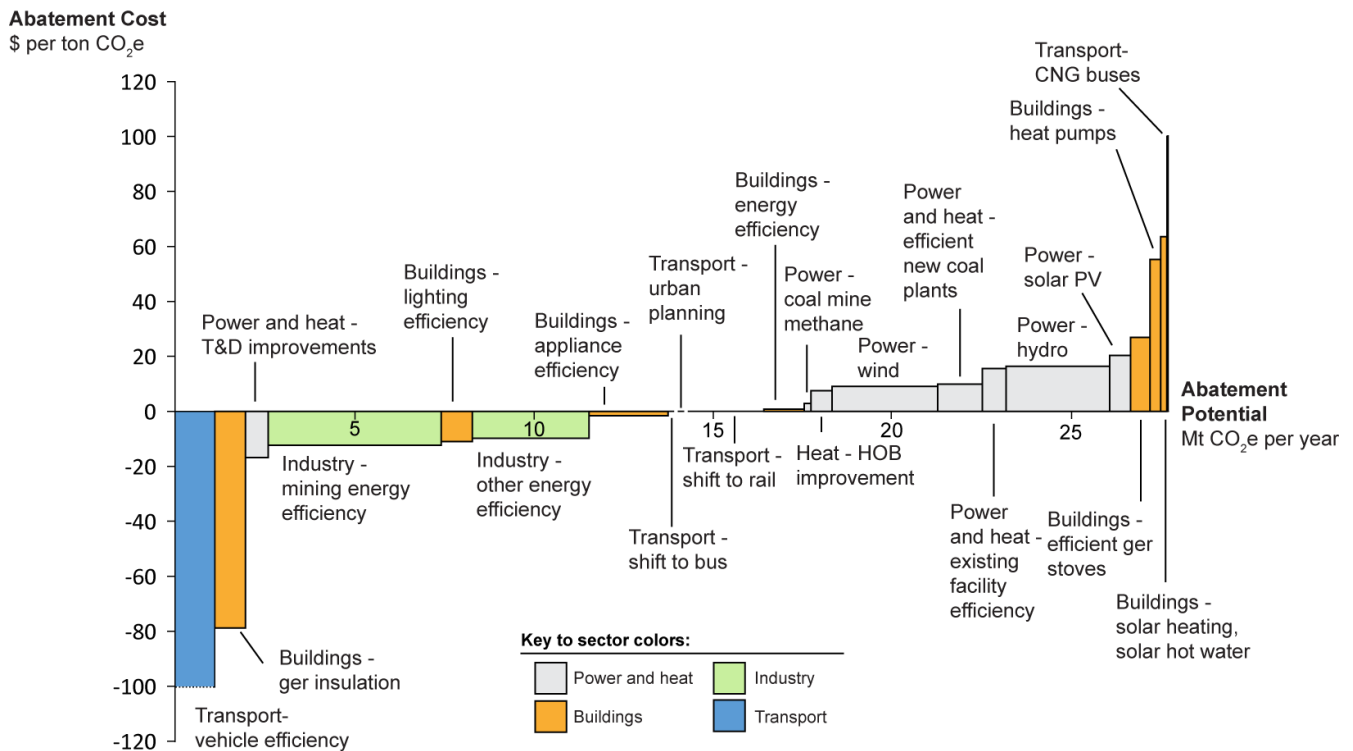

Figure ES-7 displays the GHG emissions abatement potential (relative to the *reference scenario*) associated with each of the major measures analyzed in this study. All of the measures shown here are included in the *expanded green energy* and *shift in energy export* scenario. (The *recent plans* scenario implements building lighting and energy efficiency measures, as well as more modest versions of the wind and efficient coal plant measures.)

The five measures with the greatest GHG abatement potential are (from higher to lower potential): energy efficiency improvement in the mining sector, wind power, hydropower, higher-efficiency new coal power plants, and transport mode shift to rail. The high potential for these first four measures is not surprising, given the rapid growth in the mining sector and the dominance of GHG emissions from power supply. The high GHG abatement potential from mode shift in the transport sector is

surprising and interesting, however, and derives in large part from the assumption that transport demand will grow rapidly in Mongolia (about 5% per year) and that most of that new demand will be in road transport. If transport activity does not grow that fast, overall energy use, GHG emissions, and emissions abatement potential may be less in the transport sector than indicated here.

Figure ES-8. “Cost Curve” of GHG emission abatement opportunities and cost-effectiveness of CO₂e reduced in 2035



Reductions in air pollutants such as NO_x, SO_x, and particulates would also be significant in the expanded green energy scenario.

Possible policy initiatives

This analysis suggests that several policy initiatives warrant further consideration in Mongolia. Each of these initiatives is associated with measures (as in the cost curve) that could reduce Mongolia’s GHG emissions by at least one million tonnes in 2035 relative to the reference case:

- Strengthening the 2007 Renewable Energy Law, and developing a new Renewable Energy Program, based on analysis such as that presented in this report. (Affects the power and heat sector.)
- Reforming subsidies on coal and electricity to minimize support, via tariffs or otherwise, for inefficient consumption and high-carbon energy sources. (Affects the power and heat sector, plus building and industrial energy efficiency.)

- Developing and enforcing more stringent building energy codes and appliance efficiency standards, continuing initiatives started in recent years. (Affects the buildings sector.)
- Expanding building retrofit programs from the existing programs focused on energy retrofits of existing apartment buildings (Affects the buildings sector.)
- Developing guidelines for urban planning and transportation planning, including combined land use and transportation planning, as well as a national strategy for moving people and goods, especially including rail. (Affects the transport sector.)
- Developing energy or emissions standards for widely used industrial technologies (e.g. those in the mining sector) or for primary industry sectors that produce particularly energy-intensive materials. (Affects the industry sector.)
- Enhancing vehicle efficiency or emissions standards. (Affects the transport sector.)

In addition, Mongolian ministries may wish to further explore different formulations of national goals for GHG emissions reduction. In particular, in addition to goals on territorial GHG-intensity (per unit of GDP) that MEGD has considered, developing a supplemental goal based on extraction-based GHG-intensity may help Mongolia to more comprehensively track progress towards a green economy and away from “carbon entanglement”, or the over-reliance on coal for economic growth.

Lastly, it is important to note that neither these scenarios nor this report should be read as an endorsement of any particular energy or emissions pathway. While this analysis shows what might be possible with assertive efforts by Mongolia’s government and most other economic actors in the country, other pathways are also possible, and may bring similar social, economic, and political benefits. Furthermore, none of the scenarios (even the reference scenario) should be interpreted as a definitive forecast. Mongolia’s economy is developing rapidly, and the mining, construction, and other sectors, and their associated energy use, could evolve much differently than assumed here.

Any ambitious effort to greatly expand renewable energy and energy efficiency in Mongolia will require political leadership and partnerships with the international community, as well as concerted effort to address a host of factors, from financial to technical to administrative, that have limited uptake of renewable energy and energy efficiency to date. Each of the policy initiatives discussed here could likely also benefit from further research, pilot programs, and program development.

PART I. INTRODUCTION TO MONGOLIA ENERGY SCENARIOS

1 Background

Mongolia is a landlocked country in eastern and central Asia, bordered by Russia to the North and China to the South. With an annual average temperature of -3 degrees Celsius, as well as being one of the world's most sparsely populated territories, Mongolia faces considerable challenges to provide sufficient heat and electricity for its people, especially in rural areas, both in terms of power quantity and quality. Its capital, Ulaanbaatar City, is the largest municipality of Mongolia, and is home to over one million people, comprising 45% of the total national population.

Currently, the biggest power plants in the country are coal-fired plants providing electricity and, in most cases, district heat via central networks. Many local areas still rely on coal-based heat-only boilers for district heat, and a few smaller cities, towns, and villages are still supplied with electricity from diesel-fuelled units, many of which can provide power for only a few hours per day due to lack of fuel (or funds to purchase fuel) and other restrictions. Mongolia does, however, have a significant potential for development of different types of renewable energy, including solar, wind, and some hydroelectric resources. Solar and wind power, in particular, are widely available across the country, and in recent years on the order of 20 smaller (60 to 400 kW) renewable energy systems have been developed to serve isolated communities.

Mongolia is challenged by its natural environment, its dispersed population, and pollution problems resulting from its legacy of older infrastructure. However, its natural resources, including both renewable resources and mineral resources, its capable workforce, and its excellent relations with its neighbors and the international community render it well-placed to consider and implement renewable energy development. Its challenges are significant, but relative to those of many nations, tractable.

Mongolia is playing an increasing role in providing energy, largely in the form of coal, and, to a lesser extent, crude oil, principally to China. Mongolia's status as a supplier of energy to China, and, possibly, to Korea and Japan may grow in the future, as more of the country's significant coal and renewable energy resources are developed. How Mongolia chooses to develop these resources may have impacts not only on the country's own economy and environment for decades to come, but also on global climate change.

2 Mongolia's Energy System: Overview and Challenges

Mongolia's power and heat supply is dominated by coal-fired units. For example, in 2011, 95% of electricity and more than 99% of district heat was provided by coal (IEA 2011; National Statistical

Office of Mongolia 2012). Most (about 90%) of the electricity and heat consumption in Mongolia occurs in the Central Energy System (CES), one of four relatively small, independent transmission grids. The current CES is powered largely by five coal-fired CHP plants, three of which are in the national capital city of Ulaanbaatar, and which average at least 35 years old (Minchener 2013). Installed power generation capacity totaled just under 1.1 GW in 2010, including the capacity (175 MW) of the transmission lines through which Mongolia imports electricity from (and exports electricity to) Russia.

The Ministry of Energy has plans to expand the power supply in the coming years, including the construction of CHP5, a new 450 MW coal-fired CHP plant in or near Ulaanbaatar, as well as a number of other power plants, including plants generating power from renewable resources. New power supplies are needed to meet growing electricity demand, reduce reliance on electricity imports, and improve system reliability. For context, Figure 2-1 displays historical electricity generation in Mongolia. Electricity generation dipped in the mid-1990s during the transition to democracy following the breakup of the Soviet Union, but has grown steadily since that time.

Figure 2-1. Historical electricity generation, by fuel

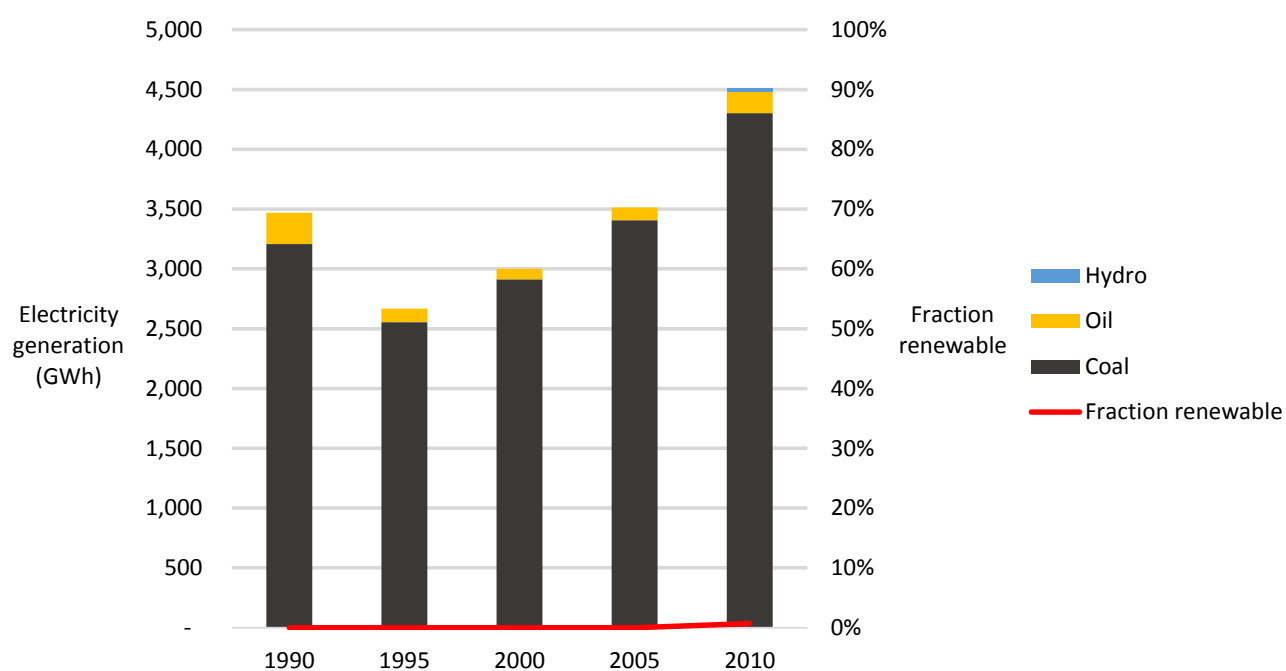

To date, Mongolia’s reliance on coal can be explained, in large part, by its significant coal deposits. According to the Ministry of Energy, 12 billion tonnes of coal are now economically recoverable (Baatar 2012; Minchener 2013): about 10 billion tonnes of thermal coal (both hard and brown coal) and 2 billion tonnes of coking coal, with a total combined energy content of approximately 200,000 PJ. By contrast, economically recoverable reserves of natural gas are considerably lower – 870 PJ (23 billion cubic meters), as are reserves of oil: 80 PJ (2 million tonnes) (BGR 2013).

Mongolia also has significant potential for other energy resources. Uranium reserves total 41 thousand tonnes (with energy content equivalent to at least 17,000 PJ), with resources possibly as high as 1.4 million tonnes (BGR 2013), spread across three deposits (Mardai, Dornod, and Gurvan Bulag). Although there are no plans currently to develop nuclear power in the country (Minchener 2013), the Mongolian state-owned company MonAtom and international technology suppliers recently established a joint venture agreement on the development of Mongolia's uranium resources.¹

Based on data from the US National Renewable Energy Laboratory (Elliott et al. 2001) and the Mongolian National Renewable Energy Center, the IEA has estimated potential renewable power generation capacity of 2.6 million MW (Minchener 2013). Another study estimated potential capacity at over 1.7 million MW, with about 0.6 million MW available at a cost of USD 100 per MWh or less (ECA 2008). Despite the potentials and the stated priority placed on renewable energy in Government policy, such as the National Renewable Energy Program, several barriers have hindered renewable energy developments to date, however, including lack of finance, management, and technical capacity (Lkhagvadorj 2010). The use of these renewable resources for power generation to meet domestic demand is complicated by the strong connection between power generation and heat production in Mongolia. Of necessity, and for reasons of efficiency, large power plants in Ulaan Baatar and other Mongolian cities operate as combined heat and power (CHP) facilities, meeting power demand in all seasons as well as district heating demands in residential and other building in September or October through May. As a consequence, an alternative source of heat will be needed if renewable generation is to substantially replace coal-fired power, and particularly CHP units. This means that a creative approach must be found to use renewable resources to meet heat demands, and/or to reduce heat requirements through demand-side measures.

Total primary energy supply in Mongolia also declined in the mid-1990s, but by 2010 returned to 1990 levels, including for both coal and oil, the most significant energy sources used in the country.

Table 2-1. Primary Energy Supply in Mongolia, 1990-2010, TJ²

	1990	1995	2000	2005	2010
Coal	104,210	93,262	76,062	78,813	102,936
Oil	34,453	14,729	18,185	23,443	34,702
Gas	-	-	-	-	-
Biofuels / Waste	3,215	3,462	5,532	7,043	6,116
Electricity (imports)	821	1,372	562	591	868
Total	142,699	112,825	100,340	109,890	144,621

¹ See, for example, *World Nuclear News* (2013), "Areva JV to develop Mongolian mines", dated 28 October, 2013, and available as http://www.world-nuclear-news.org/C-Areva_JV_to_develop_Mongolian_mines-2810137.html.

² Data for this table is from IEA (IEA 2011) for consistency with international energy statistics. Data sources used for the analysis in this report were largely Mongolian government statistics.

Total primary energy production in Mongolia closely followed domestic coal requirements in Mongolia through the early 2000s, when exporting of coal started to increase, such that by 2010 total primary energy production was over five times greater than in 1990.

Table 2-2. Primary Energy Production in Mongolia, 1990-2010, TJ²

	1990	1995	2000	2005	2010
Coal	111,527	90,598	75,673	137,354	596,168
Oil	-	-	379	1,138	12,606
Gas	0	0	0	0	0
Biofuels / Waste	3,215	3,462	5,532	7,043	6,116
Total	114,742	94,060	81,584	145,535	614,890

A number of different government ministries have mandates that affect the country's energy sector. The ministries include (Minchener 2013):

- The Ministry of Energy, which sets policies for, and oversees, power generation, electricity transmission and distribution infrastructure, and import and export of coal;
- The Ministry of Environment and Green Development, which addresses environmental standards for mining and energy use, as well as leading the country's work on greenhouse gas reduction and climate change, including preparation of the country's *National Communications to the UNFCCC*;
- The Ministry of Economic Development, which is in charge of strategic direction of the economy;
- The Ministry of Mining, which covers policy for coal exploration, oil production and trade; and natural gas exploration.

Later chapters of this report will describe the potential roles for these ministries in this study's scenarios.

In addition, several laws create the legal framework for the energy sector, including (Tovuudorj 2013):

The 2001 Energy Law of Mongolia, which split the public energy authority into a number of state-owned companies, including five generation companies, with the intent of eventually converting these to private ownership (Oxford Business Group 2013)

The 2007 Renewable Energy Law of Mongolia, which regulates generation and supply of power, including setting forth renewable energy feed-in tariffs

The 2010 Concession Law, which created the opportunity to implement energy sector projects, including new power plants, by public-private partnership.

In addition to creating and overseeing a number of programs and plans, the Ministry of Energy has also articulated a number of short and mid-term policy priorities, including the creation of an independent, safe, reliable, and integrated energy system; developing public-private partnerships to build new power plants; conserving energy and expand renewable energy; transitioning to a more market-oriented system of prices and regulation; and exploring the potential for energy exports by constructing high-voltage transmission capacity to international partners in the region and by building wind and large-scale solar PV in the Gobi for energy exports (Tovuudorj 2013).

The scenarios explored in this report build on a number of these ideas expressed by the Ministry of Energy, as well as upon a number of existing studies that analyze the possible future development of Mongolia's energy systems. In addition to the *Technology Needs Assessment* (MEGD 2013b) and draft *Energy Sector Development Plan* (egen and MonEnergy Consult 2013), several additional studies bring important data and analysis to this project. In particular, *GHG Mitigation Scenarios in Energy Sector*, a study commissioned by the Mongolian Ministry of Environment and Green Development (Dorjpurev 2013), develops a reference scenario of energy demand and greenhouse gas emissions through 2030 as well as a mitigation scenario based on a limited number of renewable energy and energy efficiency projects.

In addition, a number of other studies on more specific issues have been (or are currently being conducted), including analyses of energy efficiency improvements in the grid connected power supply by GIZ (Ernedal 2013), development of specific CDM projects, and analysis of potential GHG mitigation measures potentially suitable for the UNFCCC's proposed new market mechanisms (NMMs) (Tsendsuren 2013), and an assessment of the economics of climate change in East Asia (Westphal et al. 2013). A number of reviews of Mongolia's energy sector also exist, including by the IEA Clean Coal Centre (Minchener 2013), IIASA (IIASA 2012), and the Oxford Business Group (Oxford Business Group 2013). The unique value of this study is that it assesses energy-related measures across all major sectors of Mongolia's economy and develops four alternative, transparent scenarios of energy development in Mongolia.

3 Report goals and Objectives

This report is part of a cooperation between GGGI and the Mongolian government focused on the topic of green growth.³ This report addresses one component of green growth for Mongolia: green energy systems, i.e., those that minimize carbon, local air pollution, and other environmental impacts. It focuses on the potential for renewable energy and energy efficiency to reduce fuel use, energy

³ GGGI and the Ministry of Environment and Green Development (MEGD), formerly the Ministry of Nature, Environment and Tourism (MNET), signed a memorandum of understanding (MOU) in November 2011 to confirm a mutual agreement on the cooperative pursuit of green growth projects.

costs, greenhouse gas emissions, and other pollutant impacts. The focus is on renewable energy and energy efficiency because of Mongolia's significant renewable resources and potential for energy efficiency improvements and because these options already have considerable momentum in the country. This report does not focus as much on some other sources of energy or GHG reductions: nuclear, due to less in-country focus on this technology at present; natural gas, due to limited domestic resources or import capacity, as well as because of limited potential for GHG reductions (relative to renewables); and carbon capture and storage (CCS) due to high costs and uncertainty about the efficacy of this technology.

Part I of this report closes with the next chapter, which provides an overview of the four scenarios analyzed, including a brief discussion of the analytical methods applied. Part II of the report describes the scenario details and results, sector by sector. The first sector described in detail is Mongolia's power and heat sector. Part III of the report closes with a comprehensive overview of major scenario results and a discussion of possible policy responses and new initiatives.

4 Overview of Scenarios and Methodology

An energy scenario is an internally consistent "story" of how energy use, power and heat supply, and the underlying economy, will develop in the future. Energy scenario analyses typically start with a reference case, or "business as usual" scenario, which is a depiction of how the economy (and associated energy demand) would evolve in the absence of any new policy action. Alternate scenarios may satisfy specific aims, such as emissions reduction (of GHGs and/or other air pollutants), and reflect different pathways of economic or social development. Scenario development begins with a set of overall themes, or "storylines", such as continuation of past practices, export-oriented development, or green growth, which are then translated into economic and demographic assumptions ("scenario drivers") and strategies for meeting corresponding energy service requirements (e.g. for home comfort, mobility, or industrial production).

4.1 Scenarios analyzed

This study presents four broad scenarios of how energy supply and demand could evolve in Mongolia through the year 2035. The four scenarios were developed over the course of 2013 with input from a project advisory committee comprised largely of government officers in Mongolia:⁴

⁴ Scenarios developed for this project were sketched out by the project team (led by SEI-US) and were first discussed with the project's advisory committee in June 2013. Scenarios were revised in November 2013 based on feedback from the advisory committee in Ulaanbaatar in October 2013. For the composition of the project's advisory committee, see Appendix A. Quantitative evaluation of the four scenarios was carried out using the LEAP (Long-range Energy Alternatives Planning) software tool. A summary description of the LEAP software tool is provided as Appendix F to this Report.

- The *reference* scenario reflects a continuation of largely coal-based energy supply in an economy driven largely by mining exports, especially of coal and copper. This scenario assumes relatively few changes in energy supply or the intensity of demand other than gradual improvements in some technologies (e.g., vehicles, appliances) consistent with international trends likely to evolve regardless of changes in Mongolia’s policies.
- The *recent plans* scenario begins to introduce a shift to renewable energy and increased energy efficiency based on recent plans and priorities of the Ministry of Energy (egen and MonEnergy Consult 2013) and Ministry of Environment and Green Development (MEGD 2013b).
- The *expanded green energy scenario* describes a future where Mongolia makes an even stronger transition to renewable energy and implements extensive energy efficiency measures across its economy. This scenario also builds from work on renewable energy and energy efficiency potentials conducted in the country, including by the work of the Ministry of Energy, the Ministry of Environment and Green Development.
- The *shifts in energy export* scenario builds from the *expanded green energy* scenario; in this scenario, starting in 2017, Mongolia shifts the types of fuel and energy that it exports: rather than exporting an increasing amount of coal from Tavan Tolgoi and other deposits, the country instead exports renewable (wind and solar) electricity.

All four scenarios use the same economic and demographic growth forecasts, which draw from recent studies (UN 2013; Eurasia Capital 2011; IMF 2012), to determine the need for energy services. In doing so, they all assume rapid growth of Mongolia’s economy, especially in mining and industrial sectors, and with related effects like increasing demand for freight and personal transportation. Given the rapid changes in Mongolia’s economy, the scenarios here are subject to significant uncertainty. Table 4-1 summarizes the four scenarios. Details, and results, of each scenario will be presented in subsequent chapters.⁵

⁵ The overarching Recent Plans, Expanded Green Energy, and Shift in Energy Exports Scenarios are themselves modeled in LEAP as composites of individual options or groups of options for addressing GHG emissions. Discussions of how these overarching scenarios are composed of GHG reduction options at the sector level are provided in chapters 5 through 9 of this Report. Appendix E to this Report provides a “mapping” of options/option groups to the overarching scenarios.

Table 4-1. Overview of Four Scenarios

Scenario	Storyline	Key Scenario Drivers	Key Strategies: Energy Supply	Key Strategies: Demand / Other
Reference	Mongolia's economy grows rapidly along the lines of existing forecasts and plans, with continued growth of coal-based energy and an economy driven largely by mining exports	Economic and demographic forecasts, as developed by international institutions (e.g., Eurasia Capital 2011; IMF 2012)	Fossil power plant additions and upgrades as planned (e.g., CHP5, Tavan Tolgoi, Telmen), plus renewables that are already in operation (e.g., Salkhit Wind Park); heat provided by CHP and coal-fired heat-only boilers	Expected trends towards gradually less energy-intensive end-use technologies
Recent plans	Same as above, but with implementation of recent priority technologies as specified in Mongolia's <i>Technology Needs Assessment</i> and draft <i>Energy Sector Master Plan</i>	Same as above	Large hydropower plants (e.g., Sheuren) and wind turbines as in <i>Energy Sector Master Plan</i> ; application of more-efficient pulverized coal combustion technologies	Implement efficient lighting and improved insulation of panel apartment buildings
Expanded green energy scenario	Same as above, but with implementation of extensive energy efficiency measures and implementation of all already-proposed renewable energy projects	Same as above	Implementation of all currently-proposed renewal hydro (e.g., Elgiin, Sheuren, Orkhontul), solar PV (Sainshand, Khurmen), and wind (e.g. Govisumber, Umnogovi) power projects; reduction in electricity T&D losses	As above, but with additional energy efficiency measures in residential and commercial buildings, industry, transportation, up to potentials
Shift in energy exports	Same as expanded green energy scenario, but with shift to increased green energy exports	Same as above	Shift in energy exports from coal to renewable power to a large Northeast Asian "super grid"	Same as in expanded green energy scenario

4.2 Methodological approach

This study employs a bottom-up techno-economic analysis of energy and GHG-reduction scenarios. This type of analysis is commonly used by countries in their energy and climate change mitigation planning, as well as for in reporting to international bodies such as the UNFCCC (Sathaye and Meyers 1995; UNFCCC 2012). In a bottom-up analysis, groups of energy-saving and energy-supply measures are combined into broad scenarios that reflect alternative development choices. Energy demand is specified according to assumptions on how underlying drivers (e.g., population, mineral production) may evolve, and does not take into account responses to economic changes (such as changes in consumer spending or other macroeconomic variables) that may result from the measures introduced. This approach is straight-forward, and is more transparent to analysts and decision-makers, than more complicated methods involving economic models. This approach also provides consistency with prior scenario efforts in Mongolia, especially the country's *National Communications* to the UNFCCC (MNET 2010) and recent bottom-up analyses (Dorjpurev 2013). In this study, the scenarios are assembled in the LEAP model (Heaps 2012). For further details about LEAP, see Box 4-1 on the next page or Appendix F.

Subsequent chapters of this report (chapters 3 through 7) describe the energy-saving and renewable energy measures for each sector in detail. The project team selected these measures if they are widely considered (in local or international literature) to be scalable to bring significant energy savings or GHG benefits, at costs of up to \$100 per tCO₂e avoided.⁶ We include the measures prioritized by Mongolia's *Technology Needs Assessment* (MEGD 2013b) as well as by the draft *Energy Sector Development Plan* (egen and MonEnergy Consult 2013): large hydropower plants; wind turbines; more-efficient pulverized coal combustion technologies; efficient lighting; and improved insulation of panel apartment buildings.

Mongolia's existing greenhouse gas inventory, like all inventories submitted by countries to the UNFCCC, is based on the emissions released within the country. Using this "territorial" approach, Mongolia's emissions have been dominated by CO₂ from power and heat generation (about one-third), methane (CH₄) from enteric fermentation (about one-third), and (to a lesser extent) combustion of fossil fuels in vehicles and buildings (about one-fifth) (MNET 2010). Government policy, especially policies on Mongolia's energy supply, can affect releases of these GHGs within the country, and existing government targets for carbon intensity and carbon productivity are based on this territorial GHG inventory.

⁶ As in major international assessments of costs of abatement measures (IEA 2012a). In practice, this excludes carbon capture and storage (CCS) technology. We include one measure that we calculate to be greater than \$100/tCO₂e – CNG buses – because it has been the focus of some recent efforts focused on urban air pollution.

Box 4-1: The Long-range Energy Alternatives Planning (LEAP) System

The Long-range Energy Alternatives Planning system (LEAP) is software tool for energy policy analysis and climate change mitigation assessment. LEAP was developed at the Stockholm Environment Institute (SEI).

LEAP is an integrated modeling tool that can be used to track energy consumption, production and resource extraction in all sectors of an economy. LEAP is a demand-driven tool, in that the user first describes current and future energy requirements for households, transport, industry, and other sectors, then uses LEAP to model processes such as electricity generation, coal mining, and other energy supply systems that provide fuels for final consumption. LEAP can be used to account for both energy sector and non-energy sector greenhouse gas (GHG) emission sources and sinks. In addition to tracking GHGs, LEAP can also be used to analyze emissions of local and regional air pollutants. Finally, LEAP can track the direct costs of fuels and resources, of devices and systems that use energy, and of energy supply infrastructure so as to estimate the relative costs of different approaches to providing energy for an economy.

LEAP is not a model of a particular energy system, but rather a tool that can be used to create models of different energy systems, where each requires its own unique data structures. LEAP supports a wide range of different modeling methodologies: on the demand side these range from bottom-up, end-use accounting techniques to top-down macroeconomic modeling. LEAP also includes a range of optional specialized methodologies including stock-turnover modeling for areas such as transport planning. On the supply side, LEAP provides a range of accounting and simulation methodologies that are powerful enough for modeling electric sector generation and capacity expansion planning, but which are also sufficiently flexible and transparent to allow LEAP to easily incorporate data and results from other more specialized models.

LEAP is designed around the concept of long-range scenario analysis. Using LEAP, policy analysts can create and then evaluate alternative scenarios by comparing their energy requirements, their costs and benefits and their environmental impacts.

LEAP was developed by the Stockholm Environment Institute (SEI). More information, including access to the LEAP software and licensing options, a LEAP Users' Guide, examples of studies carried out using LEAP, and other energy-environment modeling resources is available on the LEAP web site: www.energycommunity.org.

At the same time, there are other ways to account for GHG emissions that Mongolia may influence, and which offer important added perspectives on sustainable development as well as on competitiveness in a low-carbon world. For example, current patterns of economic growth in Mongolia are strongly dependent on exports from mining. One of Mongolia's most significant exports – coal – also creates CO₂ emissions in the countries that import and burn it. To account for this practice, our analysis will also introduce a supplemental accounting for the GHGs associated with fossil fuels extracted in Mongolia (most of which are exported). Such an approach, called “extraction-based” emissions accounting, has been proposed for national accounting (Davis et al. 2011; Peters et al. 2012), and is one means to offer a more complete perspective on a country's contributions to global GHG emissions. Doing so can help assess alternative development pathways for “low-carbon competitiveness” (Vivid Economics 2009) and carbon “entanglement” (Gurría 2013). For further details on this and other accounting approaches, please see Appendix B.

4.3 Energy scenario analysis in the context of green growth

Energy strategy studies in Mongolia, as elsewhere, have often considered GHG emissions abatement, sustainable development, and other objectives. In the context of green growth, additional dimensions may be important. No universal definition of green growth exists, but key international institutions working in this area -- GGGI, the United Nations Environment Program (UNEP), and the Organization for Economic Cooperation and Development (OECD) – all emphasize improvement in human well-being while sustaining natural resources (GGGI 2011; UNEP 2011; OECD 2012).

These institutions have worked together to translate the concept of green growth into a common set of metrics to measure and track progress, in the following five categories (GGKP 2013):

- Natural asset base, such as whether natural resource stocks are being depleted;
- Environmental and resource productivity / intensity, such as measures of economic activity (GDP) per unit of emissions (CO₂);
- Environmental quality of life, especially the fraction of the population exposed to air pollution;
- Policies and economic opportunities, which may affect indicators in any of the three categories above, and which may include environmentally related taxes or subsidies that stand in the way of cleaner production and consumption, as well as measures to shift the structure of the economy;
- Socio-economic context, such as standard macroeconomic variables, and measures of equity, social inclusion, and access to services.

Though not all of these can be evaluated quantitatively here, these concepts were considered by the project team in designing the scenarios described above. (For further discussion of these indicators, see Appendix C.)

PART II. SCENARIO DETAILS AND RESULTS, BY SECTOR

5 Power and Heat Supply

5.1 Sector Overview

More than any other sector, power and heat dominate energy use in Mongolia – over 40% of final energy demand in 2011 was electricity and heat (IEA 2011). For this reason – and because power plants, heat-only boilers, and combined heat and power (CHP) plants in this sector provides power and heat to the other sectors that demand it – this report begins its discussion of scenario details with power and heat.

It should be noted that the all-fuels, all-sector energy model prepared to explore the scenarios presented in this report, though it includes annual modeling of heat and power flows in Mongolia, is not intended to model the flows of heat and power on the level of individual energy systems (for example, the Central and regional energy systems) or on a seasonal or daily basis. More detailed modeling is a possible focus for future work, given time, much more detailed input data, and possibly using other modeling tools, taking advantage of and building from the work included in the just-completed *Energy Sector Development Plan* (egen and MonEnergy Consult 2013).

5.2 Reference scenario

The reference scenario sees continuation of Mongolia’s coal-dominated power and central heat supply through 2035, with limited improvements in system efficiency and coal-fired units expanded to meet growth in demand. This growth includes the construction of CHP5, with 150 MW of capacity in 2016 and 450 MW of capacity beginning in 2017, of the Telmen power plant (100 MW beginning in 2016) and the Talvan Tolgoi plant at 150 MW in 2017 and 450 MW thereafter. The reference scenario also includes the Amgalan heat station coming online in 2014. A planned new 500 MW coal-fired CHP plant near the Chinese border from which power would be exported directly to China with no connection to Mongolian national energy system, has also been reported (Yeren-Ulzii 2012; Minchener 2013), but was not considered sufficiently certain to be included in the reference scenario.

The reference scenario also includes continued operation of the Salkhit wind farm (50 MW) as well as a number of smaller hydro, solar, and wind plants.

Other Specific assumptions are based on a synthesis of the reference case of the recently released analysis for Mongolia's *Energy Sector Development Plan* (egen and MonEnergy Consult 2013) and insights provided by the Technical Team.

In the reference scenario, for *electricity*:

- New subcritical coal-fired units, including CHP (combined heat and power) and non-CHP units, are the predominant source of new capacity. Specific additions include CHP5 (150 MW in 2016, increasing to 450 in 2017), the Western Energy System (60 MW in 2017), Telem CHP (100 MW in 2016), and (as of 2011) the 18 MW Uhaa Hudag power plants, and the expansion of other existing CHP (combined heat and power) facilities (except for CHP2, which is retired in 2016). When additional capacity beyond those units already planned is needed to meet power requirements (after 2014), new coal-fired plants using lignite coal are added,
- The only new, non-coal resource addition is the 50 MW Salkhit wind farm, which went into operation in mid-2013.
- Over 60 percent of diesel generating units are retired by 2035, as the transmission grid expands and interconnects previously isolated systems.
- Generation efficiency remains static over time, as any upgrades in performance are balanced, on average, by declines due to the aging of existing facilities.
- Own-use efficiency improves slightly at existing units. Station own use of electricity falls from, on average, 15.6% to 15.0% in 2030, with reductions from own-use improvement programs partly offset by increased in-plant electricity loads due to added emissions controls.⁷
- Electricity distribution losses fall from about 14 percent in 2010 to 10 percent by 2035 as a result of ongoing improvement efforts.
- Electricity transmission losses fall slightly over time, from 3.0 to 2.9%, as system improvements are partially offset by added losses from network extension to more remote areas.

In the reference scenario, for *heat*:

- Through the several large combined heat and power plants, including those operating today, those to be expanded, and those to be built new, a significant portion of the district heat requirements of cities and industries are met. Additional district heat requirements are provided by existing heat-only boilers (HOB), including 9 smaller and 12 larger boilers serving building heating demands in Ulaanbaatar and elsewhere. Over the next few years (through 2015), small and soum boilers with a total capacity of 300 Gcal/hr are due to be retired, replaced by 11 new units, all but one with reported capacities (each) of 30 Gcal/hr⁸. As noted above, the Amgalan Heat Station, with a capacity of 300 Gcal/hr, is assumed to come on line in

⁷ Examples of these changes, include the installation of a modified firing system in CHP-4, with new systems that increase efficiency, and reduce own-use. Recent changes have reduced own-use from 20% to 15-16%. Changes are underway to modify boilers to decrease PM emissions. Generation efficiencies for CHP units have reportedly been averaging 40-43% in winter, 29-30% in summer, though efficiencies vary substantially from unit to unit.

⁸ Based on input from Advisory Committee members.

2014. Starting in 2028, additional heat-only boilers are added to meet additional heat demand beyond that provided for by CHP units and existing HOB units.

- Station own-use of heat stays constant.
- Heat distribution losses, as calculated for 2010 based on the National Thermal Energy Balance, are assumed to fall from 2.5 percent to 2 percent on average by 2030 as distribution systems are extended with new piping, and existing systems are slowly upgraded.

Figure 5-1 displays electricity capacity in the reference scenario; and Figure 5-2 displays electricity generation.⁹

Figure 5-1. Electricity capacity in the *reference scenario*

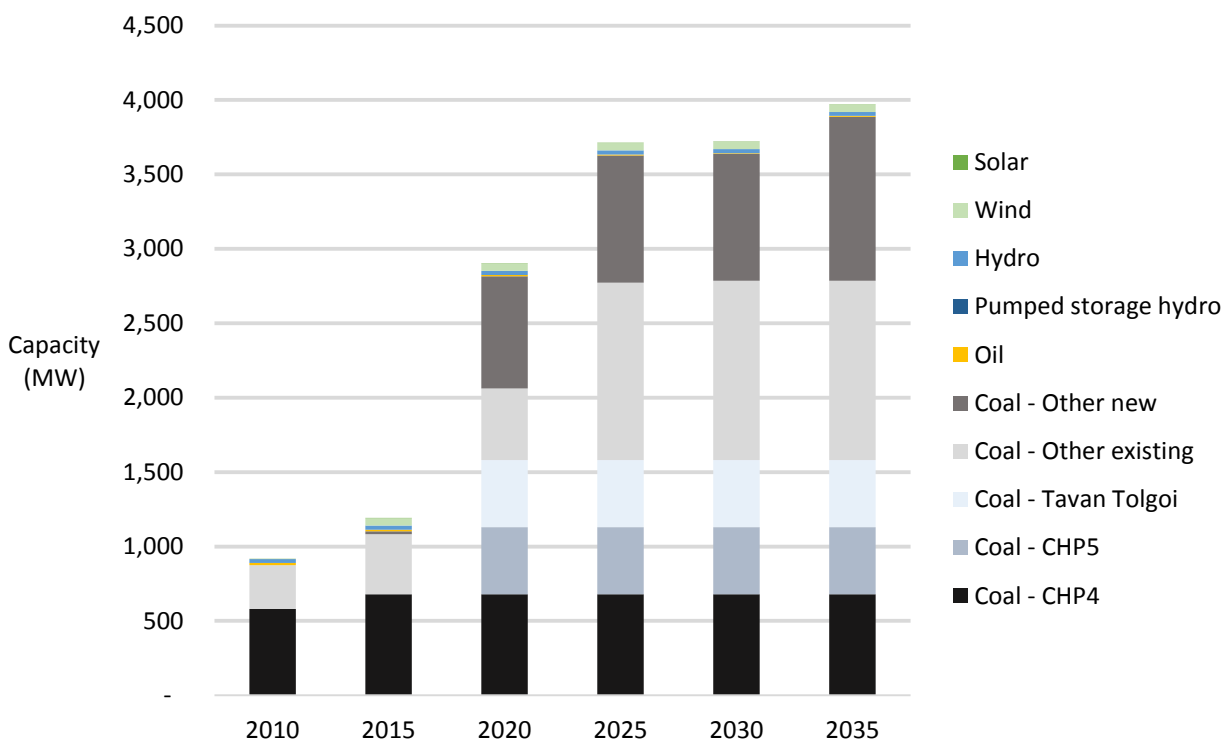

⁹ Note that both figures omit the smaller village-level renewable energy systems existing as of 2012, the capacity and output of which, though important for their local areas, are too small to appear on these national-level graphs. Note also that total generation in 2020 here is 13.9 TWh, which is between the Medium (13.3 TWh) and High (15.8) scenarios in the Draft Energy Sector MasterPlan (egen and MonEnergy Consult 2013). In 2030, our scenario of electricity generation, 18.0 TWh, is lower than the Draft MasterPlan's Low scenario, 22.1 TWh, because we assume that the rate of economic growth slows over time.

Figure 5-2. Electricity generation in the *reference scenario*

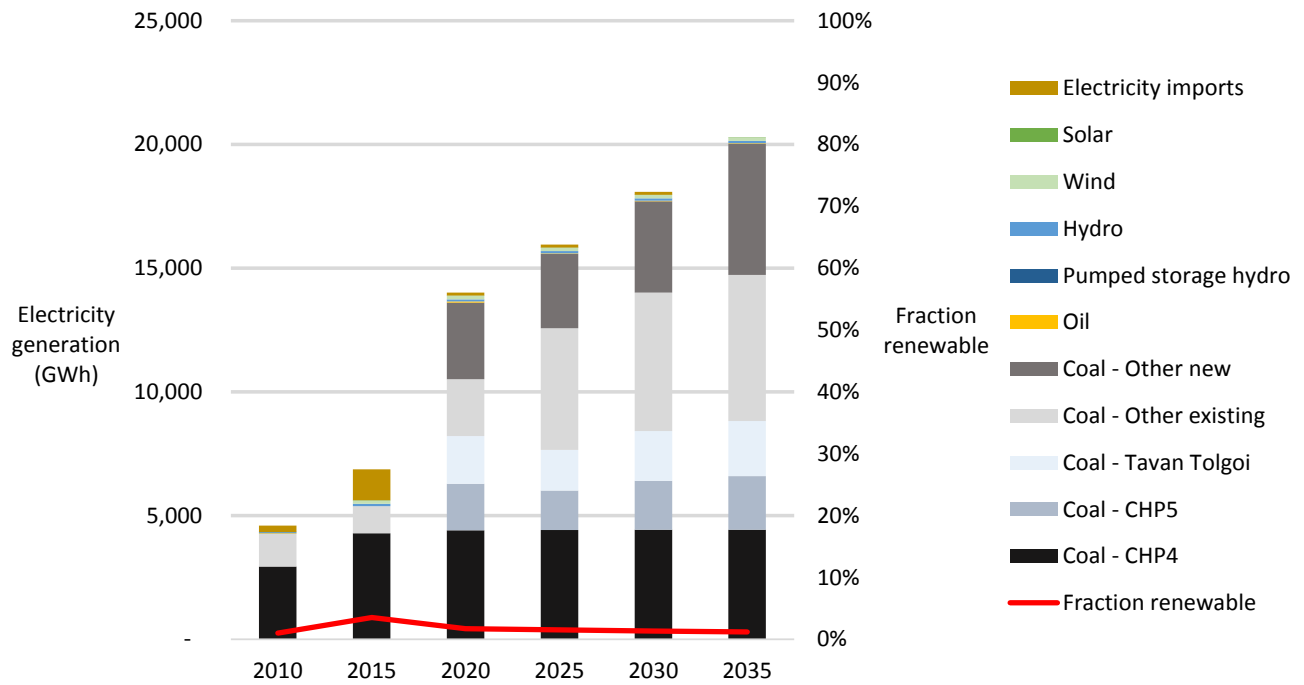
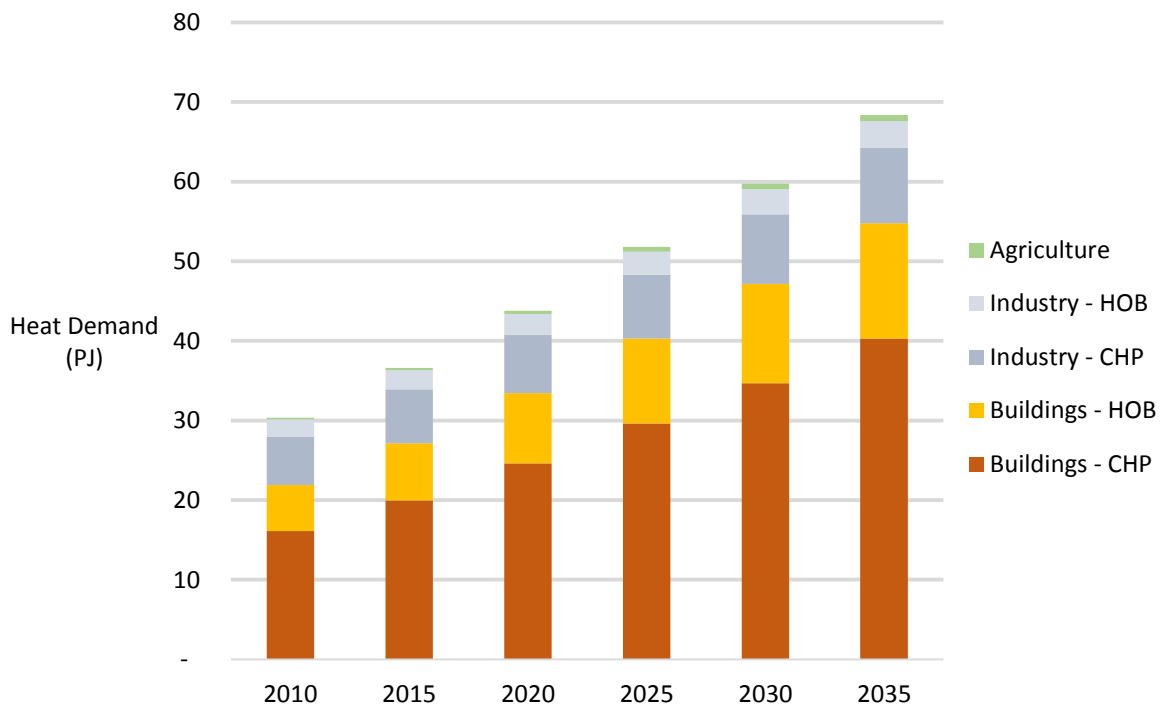

Figure 5-3. District heat demand in the *reference scenario*



5.3 Recent plans scenario

The recent plans scenario builds from the reference scenario to include additional wind resources (beyond the 50 MW 2013 Salkhit project) :100 MW of wind power in 2020, and 50 MW additional in 2022, along with the addition of the 390 MW Sheuren hydro power plant (producing 170 average MW) in 2021 (egen and MonEnergy Consult 2013, p. 82).¹⁰ Taking advantage of the additional power available from the Sheuren hydro plants, the recent plans scenario also retires a portion of CHP 3 earlier, reducing its capacity from 186 to 136 MW in 2023, and includes the coal-fired Baganuur power plant at only half of its reference case capacity, at 350 MW instead of 700 MW, when the plant comes on line in 2025, as by that time sufficient demand-side savings have accrued from the lighting energy efficiency programs (see Chapter 4) included in the recent plans scenarios as to reduce future generation capacity needs. New coal-fired non-CHP power plants included in the recent plans scenario have higher efficiency, and slightly higher capital cost, than the standard coal-fired plants included in the reference case. (New plants in this scenario are modeled as supercritical plants, compared to subcritical plants in the reference case. Another technology, circulating fluidized bed combustion, CFBC, can in some cases achieve CO₂ emissions levels comparable to supercritical plants, and can take fuels with lower heat content.).¹¹

¹⁰ Scenario 2c

¹¹ These boilers use a stream of air passing up through the boiler to suspend a mixture of burning fuel, an inert material—typically sand, and sometimes limestone or other material to absorb pollutants. CFBC plants offer some advantages with respect to flexibility in the use of coals (and other fuels, such as biomass) of different qualities, and also can have lower emissions of key local and regional pollutants, most notably sulfur oxides and particulate matter, than standard pulverized coal-fired power plants.

Figure 5-4. Electricity generation capacity in the *recent plans scenario*

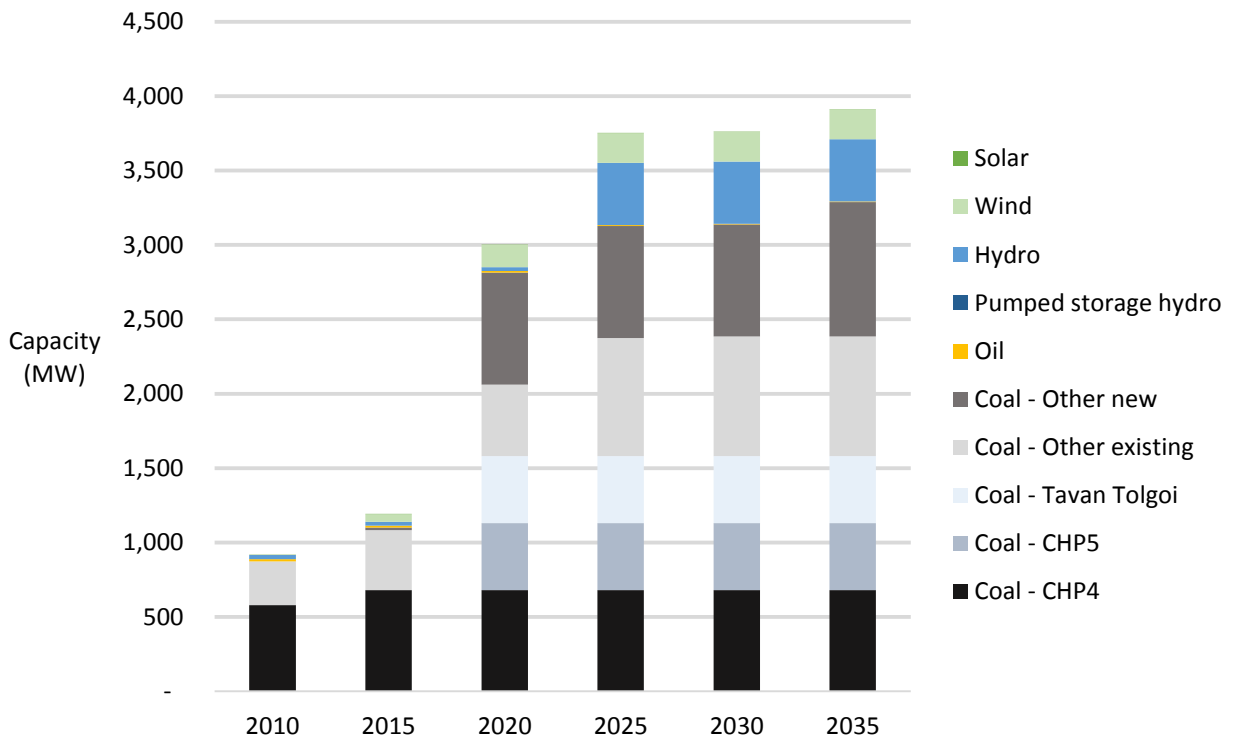
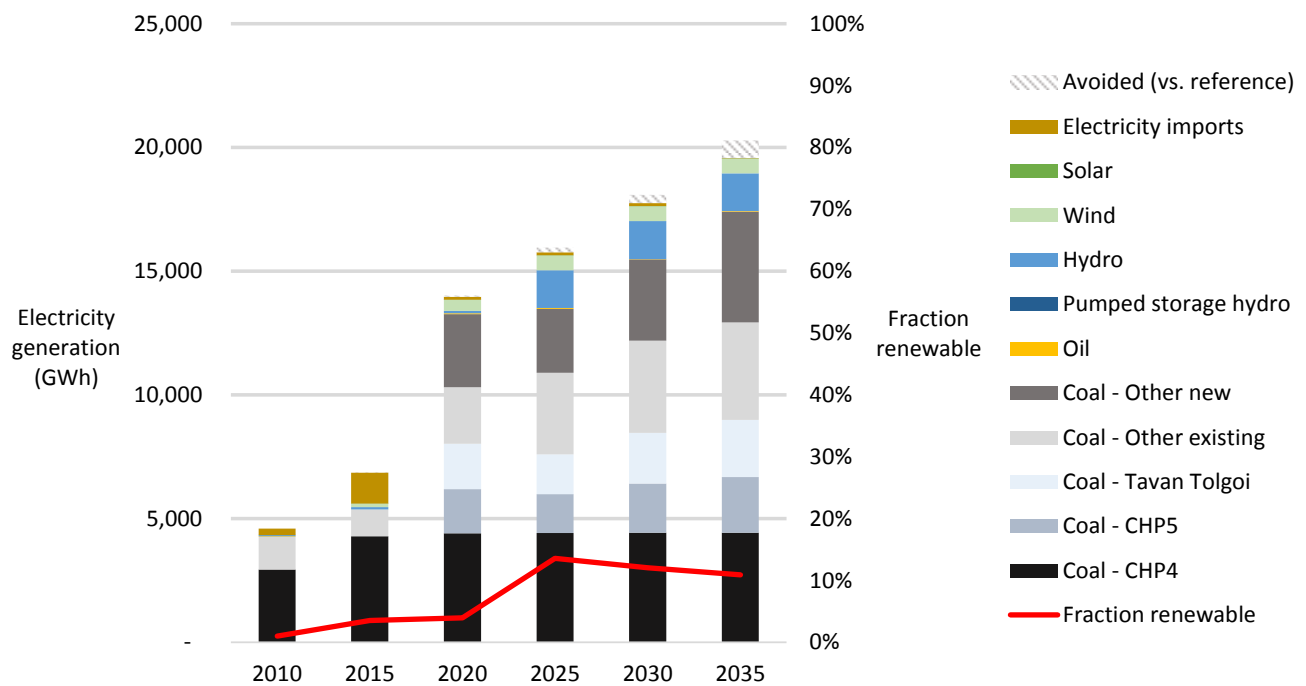

Figure 5-5. Electricity generation in the *recent plans scenario*



5.4 Expanded green energy scenario

The *expanded green energy* scenario builds from the *recent plans* scenario to emphasize renewable energy and power system efficiency improvements as the principal means to achieve economic, social, and environmental objectives in the power sector in the coming two decades. Given a now-established business model, an abundant wind resource, and increasing cost-competitiveness with coal generation, wind power expands rapidly, starting late in this decade, and, along with new hydroelectric developments, is the most significant source of new renewable energy capacity over the scenario time horizon. Wind generation capacity reaches 1000 MW by 2035. Building on recent solar and hybrid PV programs for herders and villages, solar PV installations gain a foothold in distributed and isolated systems in the coming decade, where they are most cost-competitive, and assuming that issues with panel quality and installation experienced to date can be addressed. Even more significantly, based on the assumption that system costs continue their rapid decline, grid-scale solar PV farms make an important contribution to the larger grid systems (CES and South Gobi) in the later years of the planning horizon (2025-2035, reaching over 200 MW by 2034). The first large-scale hydropower facilities, the Sheuren plant and others, come on line as soon as late in this decade, followed by other large hydropower projects after 2020, resulting in total hydroelectric capacity of over 750 MW by 2035. Hydroelectric development in this scenario assumes that social and

environmental concerns associated with large hydro projects are adequately addressed. Together, these renewable resources are sufficient to significantly exceed the nation's renewable electricity output target of 20% by 2025 (reaching 35%), ultimately achieving over a 40% share of output by 2030.

Significant penetration of dispersed and intermittent wind and solar resources will require corresponding investments in grid infrastructure in order to provide sufficient transmission, storage, and balancing services, including voltage control and grid stability. Concomitant development of hydropower capacity will be important for providing firm capacity to back up intermittent wind and solar units, utilizing the ability of hydroelectric plants to act indirectly as electricity storage, and to thus reduce efficiency penalties from increased cycling at coal-fired plants. This scenario also envisions construction of a pumped-storage hydroelectric facility at a capacity of 100 MW by 2016¹², with total pumped-storage capacity expanding to 200 MW in 2020 and 300 MW in 2023, which may be important in enabling a higher penetration of wind and solar and allowing more efficient coal plant operation by reducing the need to increase and decrease coal plant output to meet changing power loads. (Such a service may also be provided by Sheuren or other hydropower plants, potentially, though not necessarily, precluding the need for pumped storage hydro.)

Development of these more geographically-dispersed renewable resources will create new employment and economic opportunities, contributing to "green growth." That said, large-scale penetration of renewables could face a number of challenges, given the lower average wind speeds and solar insolation during Mongolia's peak winter electricity demand seasons, as well as future variations in season precipitation that could affect hydro power operation.

Therefore, another important element of the expanded green energy scenario is modernization and efficiency improvement of the coal power fleet. This includes efficiency improvements in heat and electricity transmission and distribution, upgrading/replacement of existing boilers and power plants, coal processing for improved efficiency of combustion and reduced pollutant emissions, using higher-efficiency coal-fired plants when building (before 2020) new coal-fired plants, building higher-efficiency, though higher cost, ultra-supercritical coal-fired power plants instead of standard power plants when additional capacity is required, and other options.

Nuclear energy could also potentially play a role in Mongolia's energy future, leveraging the country's significant uranium resources. This option, however, is more likely to be attractive beyond the 2035 timeframe of this analysis.

¹² Pumped-storage hydroelectric facilities store electrical energy by using off-peak power to pump water uphill into a storage reservoir, releasing stored water to flow back down through a channel or penstock (pipe) to turn a turbine generating unit and produce power at times of higher demand.

The specific assumptions for the expanded green energy scenario are adapted in part from those developed for the high-renewables, emission-reduction scenario (2c) recommended in the draft *Energy Sector Development Plan* (Energy Masterplan) out to the early 2020s (the Masterplan update includes projections through 2025) (egen and MonEnergy Consult 2013). The draft Masterplan update found that this scenario, while vastly expanding system diversity, reducing coal combustion emissions, and creating new economic opportunities, would result in NPV costs only 5 to 8% higher than the reference case.¹³ The expanded green energy scenario described here departs from the Masterplan in that it adopts renewables somewhat faster, and adopts extensive demand-side measures (see next sections) employed result in a slower demand growth for electricity and other energy forms, and enable the delay or deferment of the addition of new coal-fired power plants and potentially other (including renewable) resources, often for years, which will lead to significant reductions in both capital and operating expense requirements by reducing the costs of required infrastructure. From the mid-2020s, most additional electricity demand is met by a mix of new renewable resources.

It is important to note that the draft Energy Masterplan focuses on the Central Energy System. Its expansion plan meets the country's renewable energy target only for the CES, and does not speak (at least in the draft executive summary) to renewable energy development for the South Gobi and other isolated grids. The expanded green energy scenario considered here thus envisions development of distributed small-hydro, PV, and wind systems for the Eastern and Western regions, as well, up to a total hydro capacity of over 750 MW, nearly 300 MW of central-station solar PV and solar thermal combined heat and power capacity (with additional distributed solar PV, as noted in Chapter 4), and 1000 MW of wind capacity by 2035. Although the geographical locations of these generation resources are not explicitly included in the LEAP model, they could include deploying wind capacity in the South Gobi to supply energy for minerals production there, or greater penetration of renewable energy on the Central and other grids to offset coal-fired power production at and for mine-mouth power plants such as the planned Baganuur and Shivee Ovoo power plants.

It is likely that the implementation of the renewable electricity components of the expanded green energy scenario will require at least somewhat different configurations of transmission capacity infrastructure than the reference case. The expanded green energy scenario currently assumes slightly higher average transmission and distribution (T&D) costs than the reference case, largely to fund improvements in T&D efficiency improvements. Depending on the location of new renewable electricity plants in this scenario, as well as of coal-fired plants **not** built in this scenario (but built in the reference case), either more or, possibly, less T&D investment could be required in this scenario (which also requires substantially less electricity generation overall due to savings in demand through

¹³ Depending on the weighted average cost of capital (WACC) assumed, per Tables 42 to 44 of the draft MasterPlan (egen and MonEnergy Consult 2013)

implementation of energy efficiency measures). Determining the ultimate impact of this scenario on overall T&D investment requirements is beyond the scope of the current study, but may be an important topic for future research.¹⁴

In the expanded green energy scenario, the renewable energy facilities described above are used at full capacity when resources are available to take advantage of their very low operating costs relative to fossil-fuelled plants, with coal-fired and pumped-storage plants providing load-following capabilities. Note that the overall electricity demand required of the expanded green energy scenario is lower than in the Reference case—by nearly 15 percent in 2025 and over 36 percent in 2035—enabling renewable energy targets to be met with reduced additions of renewable generation.

Finally, the expanded green energy scenario makes increasingly greater use of ground source heat pumps as well as solar water heaters for heat (space and water heat) supply on the demand side and also reduces overall heat demand in the buildings sector, curtailing the need for heat-only boilers (HOB).

Figures Figure 5-6 and Figure 5-7 show, respectively, the trends in electricity generation capacity and in output by plant type in the expanded green energy scenario. Although capacity in this scenario is in most years slightly greater than that of the reference case (and about 500 MW greater in the years following major hydro additions), the output electricity in the expanded green energy scenario is significantly less, due to a combination of the addition of significant intermittent resources with lower capacity factors than coal-fired plants, and to the lower electricity demand due to aggressive application of energy efficiency measures on the demand side.

¹⁴ Similarly, examining the costs and benefits of improved transmission interconnections between the Central and Eastern and Western electricity grids has been beyond the scope of this study. Interconnection of the three grids in Mongolia could bring reliability benefits, and could ease the process of connecting wind, solar, and hydro resources to the grid. A number of major transmission projects have been planned by both government and private organizations to both interconnect the grids and to provide routes to electricity markets for proposed new large coal-fired power plants. Exploring the costs and benefits of the various options for stronger interconnection of the separate grids, and the interaction of interconnections with prospects for expanded renewable power generation, is a topic that merits further study.

Figure 5-6. Electricity capacity in the *expanded green energy scenario*

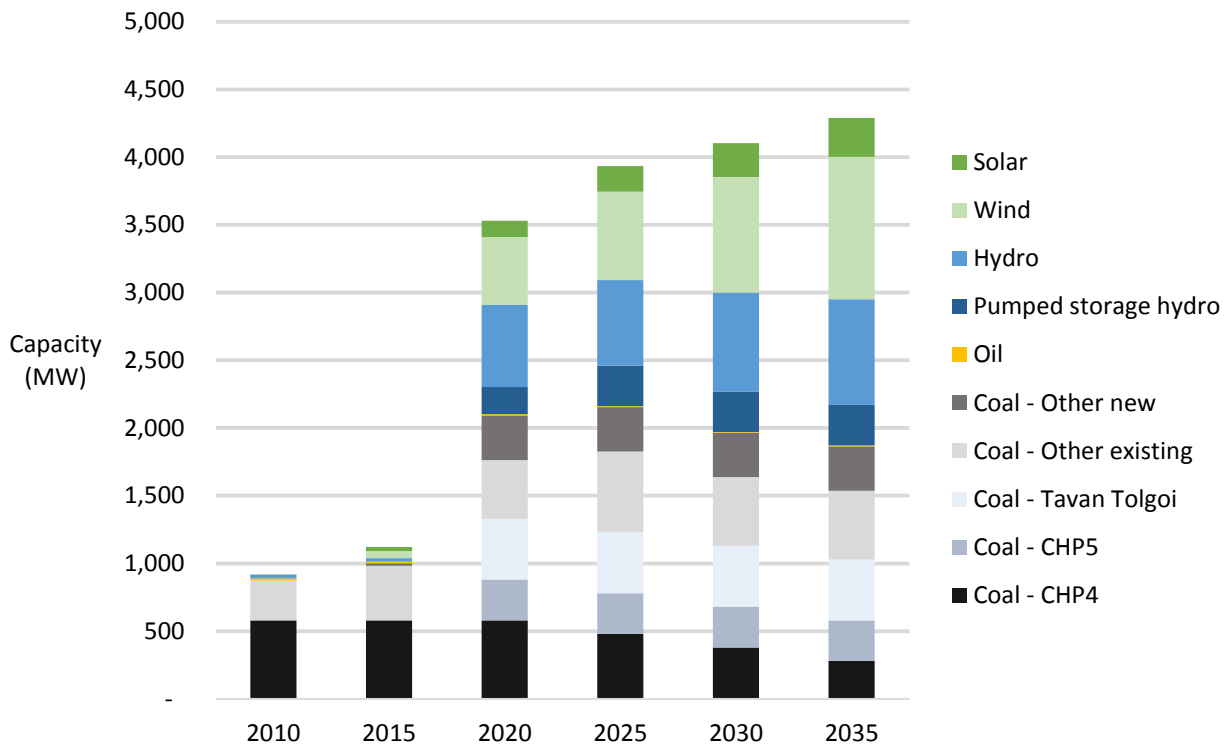

Figure 5-7. Electricity generation in the *expanded green energy scenario*

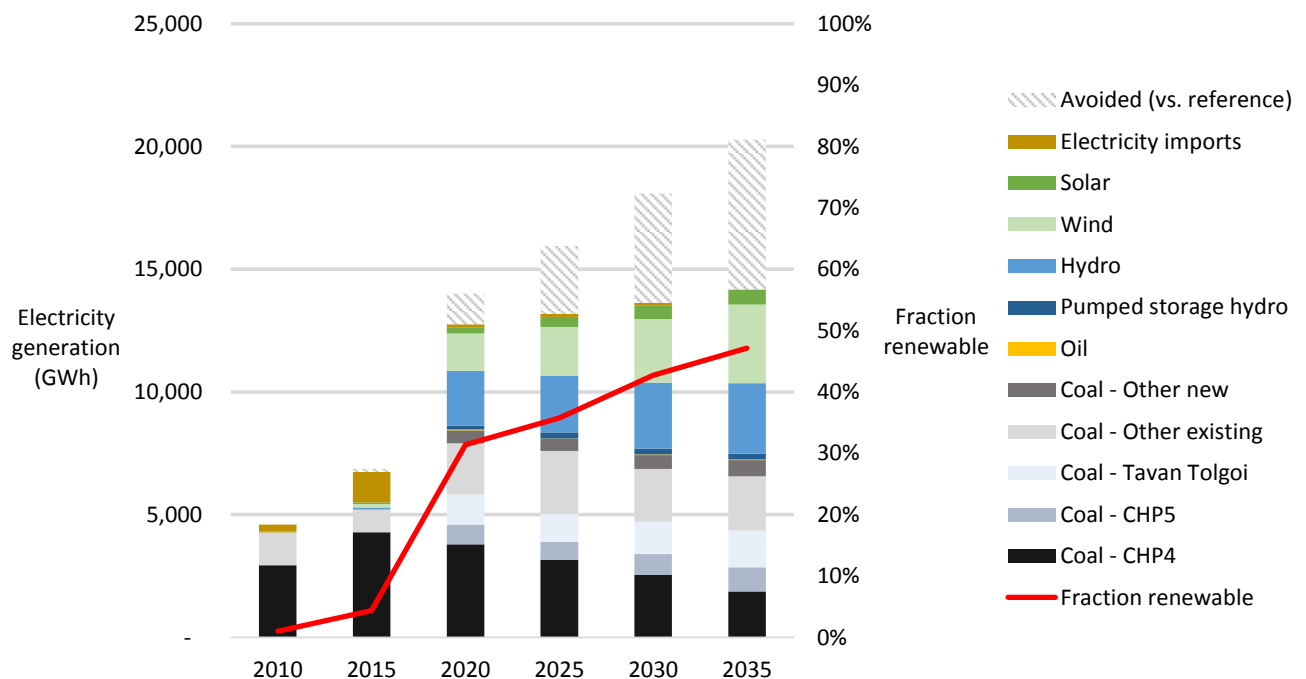
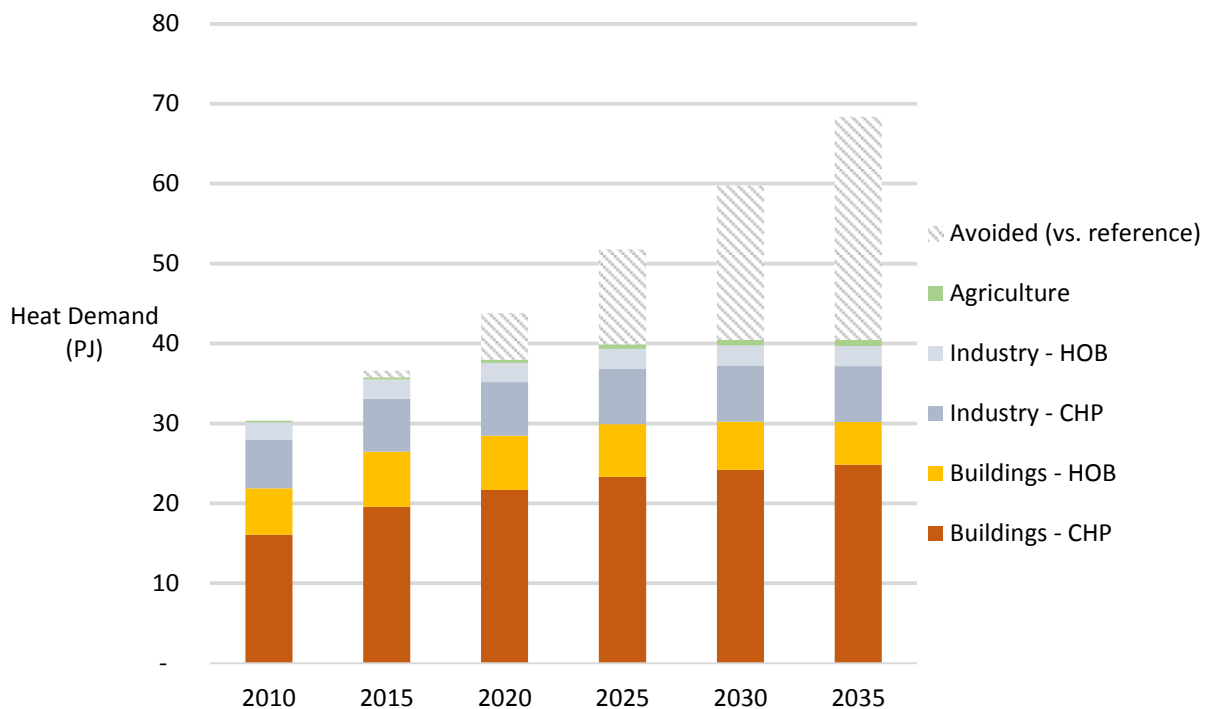

Figure 5-8. District heat demand in the *expanded green energy scenario*



5.5 Shift in energy export scenario

In the shifts in energy export scenario, Mongolia makes two significant and highly ambitious shifts in the type of energy it exports. First, it extensively develops its solar and wind resources in the Gobi desert, exporting renewable electricity to other nations in Northeast Asia. Second, it dramatically reduces its exports of coal (both thermal and coking coal), and does not pursue export of coal-fired electricity.

In the power sector, the rationale for this scenario is to take advantage of growing regional electricity demand (e.g., from China) while pursuing rapid renewable electricity deployment as “green growth” in Mongolia. Coupled with its rapid growth and limits on CO₂ emissions and coal usage, China is increasingly looking to electricity imports to help reduce its coal consumption, including to make greater use of transfers of electricity from west to east (Maidowski 2012). Mongolia’s wind resource is greater than that of all of China, even though China’s land area is greater. Further development of regional, northeast Asian electricity markets, supported by a regional grid, could also enable Mongolia to sell electricity to help meet demand growth in other countries in northeast Asia, including Japan and Korea. Mongolia has long been involved in studies and discussions with international partners for a regional electricity grid, and the concept could start becoming reality early next decade (Song 2013)

Mongolia could create significant in-country economic growth, while reducing global greenhouse gas emissions, by exporting renewable energy to help meet this regional electricity demand. The shifts in energy export scenario demonstrates what might be possible with highly ambitious political, financial, and technical commitment from a variety of actors.

Indeed, renewable energy exports has gained traction among some government officials in Mongolia, including President Tsakhia Elbegdor¹⁵ and Minister of Energy Sonompil (Oxford Business Group 2013, p.135). Despite the great challenges, the prospect of planning for a regional northeast Asian electricity grid, coupled with significant renewable energy supplies from Mongolia's Gobi region, may be more likely now than at any other time in the past.

In this shifts in energy export scenario, Mongolia rapidly builds out solar PV and wind resources in Gobi region, starting with 30 MW in 2017 and then growing with installations growing at an annual rate averaging about 60% (higher in early years, lower in later years), an average rate of renewables expansions that matches China's over the past two decades (IEA 2012b).

At this level, Mongolia could install nearly 12 GW of renewables in the South Gobi by 2031, displacing a significant fraction (potentially even all) of the value of coal exports by that time, depending on the value of exported electricity and fossil fuels. For example, if, as assumed in preparing this scenario, the price received for renewable electricity exports covers production costs (including both capital and operating costs), assumed to start at an average of about \$117 per MWh in 2017 (the average of solar PV and wind power production costs in 2017 in this analysis) and declining gradually thereafter as costs, especially for solar PV, decline) and coal prices hold constant at about \$48/tce (as in the draft *Energy Sector Masterplan*) – Mongolia could offset the value of its reference scenario coal exports. As such, this scenario reduces Mongolia's coal production by about 90 percent, respectively, relative to the reference scenario (in which it was expected to grow dramatically), with the remaining 15% remaining to be used domestically. These reductions also reduce the energy use (especially for coal production) and greenhouse gas emissions associated with production of those the two fuels. Exporting this amount of power will require large investments in transmission and distribution facilities, probably with multiple connections to entry points on the Chinese grid as well as high-voltage direct current (HVDC) lines to other nations, such as Korea and Japan. There are multiple possible scenarios, depending who the buyers of renewable electricity generated in Mongolia would be, where the plants in Mongolia would be located, how these lines might be configured, and which participants in an export/import project would pay what fractions of the overall required costs. Exploration of these T&D scenarios for renewable electricity export has been beyond the scope of this study, but a worthy topic of, for example, a multi-national research effort. Even 12 GW of renewable

¹⁵ <http://www.rtcc.org/mongolias-green-gold-revolution-in-un-spotlight/>

power, however, represents just over 2 percent of the solar resource in the South Gobi region¹⁶. Electricity generation included in the shift in energy exports scenario – about 27 TWh – would be less than 1% of China’s forecast electricity consumption in 2030. (IEA 2012b)

Substituting exports of fossil fuels for exports of renewable electricity could help Mongolia to substantially increase the country’s “low-carbon competitiveness”, should global demand for fossil fuels begin to decline based on concerns over climate change (Vivid Economics 2009; HSBC 2012). For example, if major economies were to take a path similar to that in the IEA’s “450 ppm” scenario, emissions associated with fossil fuels could be subject to limits or carbon prices, demand for coal could decline, and countries with economies highly dependent on coal and other high-carbon exports could be exposed to much greater risk and, potentially, stranded assets (Carbon Tracker Initiative 2011). The shift in energy export scenario would be one means for Mongolia to prepare for such a risk while also diversifying its economy away from mineral extraction, another commonly cited goal.

At the same time, this scale of renewable energy investment and export brings up a host of issues, among them: how to finance, build, route and price transmission capacity to take power to non-adjacent countries; how renewable energy “credits”, or credit for avoided greenhouse gas emissions, might be shared between nations; how to address the intermittency of solar and wind resources; how to organize the governance and operation of international power lines carrying renewable electricity to markets in other nations, and a host of other economic, technical, and institutional issues (Maidowski 2012; Chen et al. 2010). Due to the high potential for economic growth, reduction of economic risk, and reduction in global greenhouse gas emissions (perhaps the greatest potential of any option in this study), the potential to shift energy exports from coal to renewable electricity deserves significantly more research.

Figure 5-9 and Figure 5-10 show, respectively, the trends in electricity generation capacity and electricity output in the shift in energy exports scenario. Here, for simplicity, we have assumed that the added electricity for export would be an equal mix of solar PV and wind power. The added capacity for export brings Mongolia’s total electrical capacity to 18.5 GW in 2035 and total generation to 42 TWh.

¹⁶ The solar energy potential of the Gobi desert has been estimated at 1092 TWh (Terawatt-hours); see Newcom Group, undated, “physical solar potential of Mongolia’s Gobi desert”, available as https://iref.or.jp/images/pdf/20110912/110912_Newcom.pdf.

Figure 5-9. Electricity capacity in the *shift in energy export* scenario

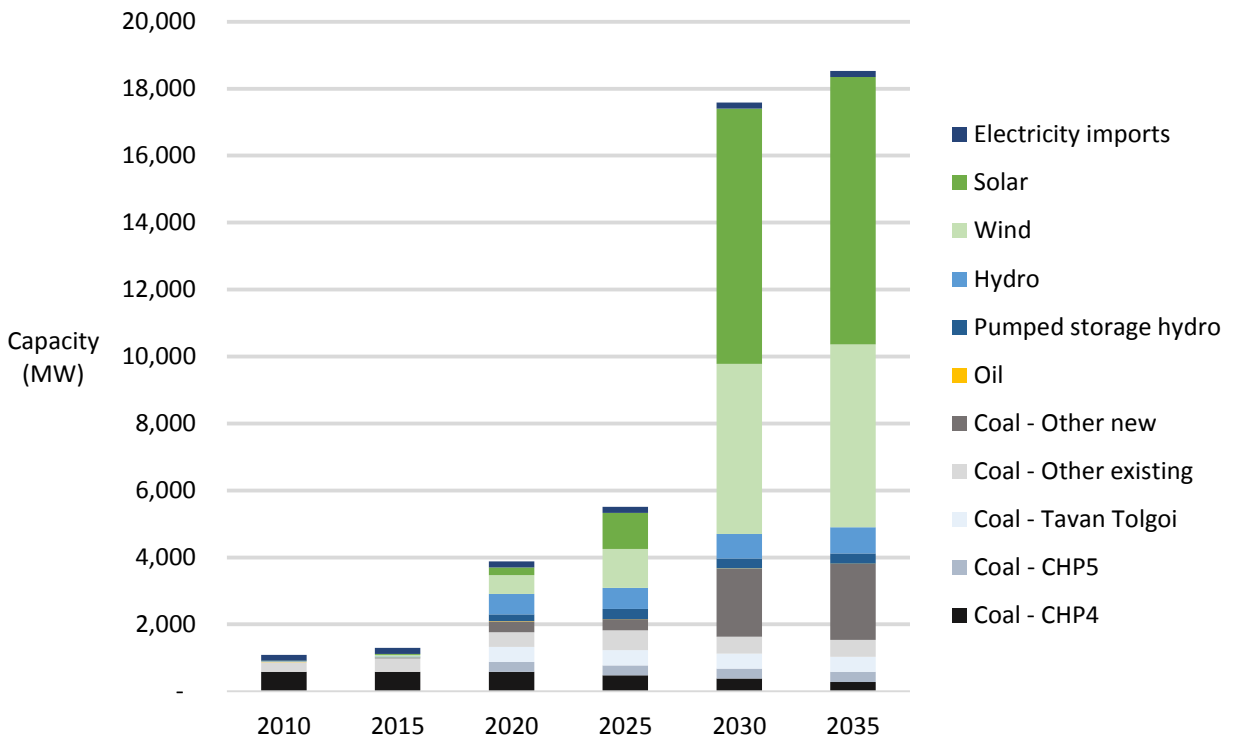
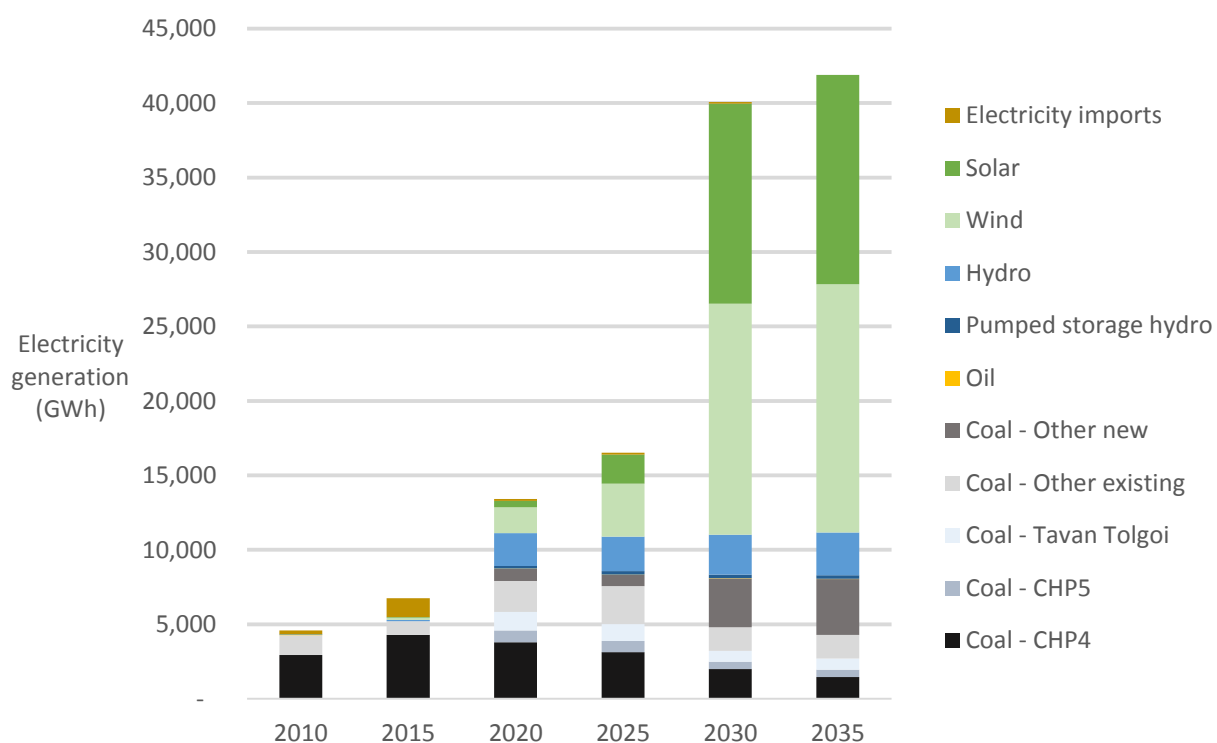

Figure 5-10. Electricity generation in the *shift in energy export* scenario



5.6 Discussion and possible initiatives

The power and heat sector plays a central role in both providing key energy services in Mongolia and in the overall current and future greenhouse gas emissions in the nation. How Mongolia's power and heat systems are developed will, to a large extent, determine the future greenhouse gas emissions of the nation. As seen in the scenario results above, the industry and buildings sectors together comprise well over half of Mongolia's future GHG emissions, suggesting the importance of electricity and heat supply to these sectors (as well as efforts to reduce these sectors' energy demand).

Later chapters of this report will describe measures to reduce electricity and heat demand. Together, efficiency measures can substantially reduce future demand, such that growth in overall electricity and heat demand may decrease from an annual growth rate of 4.6% to a rate of about 2.8% per year. If these efficiency measures can be implemented, and result in electricity consumption savings similar to those projected, Mongolian energy planners may not need to focus as much on increasing supply in the future. This could make it easier to meet renewable energy goals, as there may be less pressure to rapidly scale up power supply using coal-fired units. Note, however, that a crucial element of the

success of any demand-side program to reduce heat requirements will likely be to implement heat metering and control technologies, as well as heat pricing systems that assure that heat producers recover, at least on average, the full costs of heat production. Heat tariffs that adequately reflect the cost of heat generation provide heat users with the incentive to conserve, and control mechanisms—valves and thermostats, for example—provide users with the control they need to moderate their heat demand as desired.

Mongolia has rich solar and wind energy resources, which (together with hydropower) will be critical in meeting renewable energy targets and emission reduction goals set out by the Mongolian government. At present, two major policies guide Mongolia's renewable energy development: the 2005 Renewable Energy Program and the 2007 Renewable Energy Law. The Renewable Energy Program set forth the goal of renewable energy comprising 20 to 25 percent of total national energy production in 2020 and set forth a number of projects (e.g. to construct specific hydropower plants, to electrify soum centers) and research (e.g. feasibility studies) aimed at expanding renewable energy in the country. The Renewable Energy Law regulates generation and supply of power, including setting forth ranges for renewable energy feed-in tariffs.

To support the growth of renewable energy in Mongolia along the lines of this study's *expanded green energy scenario*, policymakers in Mongolia could:

1. Strengthen the 2007 Renewable Energy Law, to renew momentum and to take into account recent priorities, perhaps based on the scenarios in this study, or on subsequent analysis, by the Ministry of Energy.
2. Develop a new Renewable Energy Program. The 2005 Renewable Energy Program could be updated to reflect the Ministry of Energy's latest analysis and priorities for renewable energy, as they may be developed based on the LEAP model or other assessments. A new renewable energy program would need to be coordinated with other programs and plans such as the National Action Program on Climate Change (MEGD), Green Development Strategy (MEGD) and Investment plans and list of concessions (MED), among others.

These steps would involve coordination among a number of ministries, led by the Ministry of Energy (MoE) and involving the Ministry of Economic Development (MED) and Ministry of Environment and Green Development (MEGD). (For a diagram of these ministries and their relevant agencies and state-owned enterprises, see Appendix D.)

To support either of these options, further research may be necessary, building from this study, the draft *Master Plan*, and other efforts. In particular, further research could address the following key issues:

- Intermittency and storage. Wind and solar resources are by their nature intermittent, meaning that either other, likely fossil-fueled resources, electricity storage on a large scale, or a combination of the two would need to be employed for renewable power generation to

operate effectively in Mongolia's energy system. In tandem with consideration of intermittency and storage, changes in transmission and distribution infrastructure needed to accommodate new wind and solar resources, and to adjust to changes in coal-fired capacity (plants retired early and plants not built in an expanded green energy case), should also be researched.

- Renewable heat. One key question is how to provide heat for residential and other buildings using renewable energy. One advanced option is to use ground-source heat pumps to turn electricity into heat at very high efficiencies.¹⁷ It may also be possible generate and then store heat for hours, days, or even between seasons. Heat would then be released to the district heating system (or to an individual home or building) when needed. Lastly, a simple (though less efficient) option may be inexpensive resistance heaters in homes and businesses, or adding resistance coils to district heating systems so that those systems can use renewable electricity when it is available as surplus.
- Heat tariff reform and control systems. As noted above, district heat must be priced sufficiently to recover the costs of heat generation, and control systems need to be provided at the consumer level to allow heat system improvement and/or renewable heat programs, whether on the demand or supply sides, to be effective.

In addition, this analysis includes a *shift in energy export* scenario that describes a major role for Mongolia in supplying electricity to northeast Asia, such as China, Korea, and Japan. This is a promising option for Mongolia to contribute to economic growth by exporting a product (renewable electricity) with significant global GHG benefits. Seeing this option to fruition, whether through government-owned plants or from plants owned and operated by the private sector, will require intensive work on a number of issues, ranging from the technical to the economic to the political, and partnerships with the wide variety of stakeholders involved in regional cooperation on electricity systems, including UNESCAP and the Greater Tumen Initiative (GTI), as well as the governments of neighbor countries.

Lastly, while increasing the deployment of renewable energy and decreasing energy demand would both help increase the fraction of renewables in electricity and heat supply in the country, so would reducing the emphasis on the greatest source of power in the country: coal. According to the International Monetary Fund, Mongolia has devoted a greater share of its GDP to subsidizing coal (4.6%) than any other country analyzed, including major developing-country coal producers China

¹⁷ Resistance heaters convert electricity into heat with an efficiency of essentially 100 per cent. Heat pumps use electric motors and pumps to compress and expand a "working fluid" to move heat from the ambient air or water or, in the case of ground-source (or "geothermal" heat pumps, from the earth, resulting in an overall efficiency that can be well over 100 percent. Depending on the conditions, ground-source heat pumps can produce heat from electricity at an efficiency of 300 percent (or a "coefficient of performance" ratio of heat out to electricity in, of 3.0) or more.

(3%), India (1.9%), Indonesia (0.5%), and South Africa (2.5%) (IMF 2013). Reforming these subsidies could help decrease the costs of renewable energy relative to coal-fired power.

6 Buildings

6.1 Sector Overview

Buildings, both for housing and businesses, demand large quantities of energy, especially for heating. Trends in living patterns and housing stock will affect future energy demand in Mongolia. On the one hand, construction of new, more energy-efficient buildings could reduce the future energy intensity of the overall building stock. On the other hand, expanding use of appliances and electronics, as well as steadily increasing size of residential dwellings (National Statistical Office of Mongolia 2012) and use of glass in commercial buildings, could contribute to increasing energy intensity.

The buildings sector in Mongolia is divided into two main subsectors, the household subsector and the “commercial and other” subsector. The Household subsector includes urban and rural households, with urban households further divided into households in Ulaan Baatar, and households in other cities. Rural households are divided into those in soum centers and herder households with and without connections to the fixed power grid. Urban households in UB are modeled in three groups: apartments, most of which are served by district heat, houses, which are not served by district heat, and gers also not served by district heating systems. Household end-uses include heating, cooking, lighting, and other uses, with the designation of end-uses varying somewhat by the type of household. Table 6-1 lists key drivers for the buildings sector.

Table 6-1. Key Drivers, Buildings Sector

Driver	2010	2015	2020	2025	2030	2035
Population (million)	2.8					4.1
Households (thousand)	742	841	945	1,039	1,117	1,186
Urban	464	547	624	696	765	830
Ulaanbaatar	312	361	418	473	528	581
Other Cities	136	136	150	163	173	166
Rural	278	294	321	343	352	356
Herders	185	176	171	160	141	142
Soum Centers	94	118	150	183	211	214
Commercial and other buildings						
Building volume (M m ³)	31	36	42	49	54	60

6.2 Reference scenario

In the reference case, energy use in households is in part driven by population growth, plus an ongoing decrease in the size of households, with the combination leading to an increase in the number of households, as well as by growth in personal income. Population is expected to grow from 2.8 million in 2010 (National Statistical Office of Mongolia 2012) to 4.1 million in 2035 (UN 2013)⁽¹⁸⁾, creating an increased demand for housing. Improvements in energy efficiency, e.g. due to more-efficient appliances or to better-insulated buildings, will tend to be more than balanced by increases in consumption due to greater size of dwellings and higher use of appliances and electronics.

Development of commercial and institutional dwellings is expected to increase in urban areas, especially in UB, which has a city development plan calling for increases in both housing and social infrastructure—commercial, education, recreation, health care, and other services.

Urbanization increases in the reference scenario, with 70 percent of households in urban areas by 2035 (up from 63% in 2010 and 43% in 1990), and with 70 percent of those households in Ulaanbaatar (UB). Both within UB and in other cities, a greater fraction of households are housed in apartments over time and less in ger districts. Urbanization tends to increase energy intensity compared to housing in the ger districts or rural areas, as more appliances are used.

Increases in appliance use, as greater incomes allow for greater penetration of lighting, televisions, computers, and other appliances. The intensity of electricity use in cooking is assumed to grow at 2% per year, and the intensity of LPG use in cooking grows at 1 percent annually among apartment dwellers, though there is also a trend towards more use of LPG as a cooking fuel. The ownership of other major appliances among apartment dwellers, already at or near full saturation in UB, is assumed to change relatively little over time, and the energy intensity of those appliances also changes little, as trends toward increasing use and/or size of appliances are balanced by general improvements in energy intensity. The use of other electric devices, however, increases with increasing income. In the aimags, increased electrification means better access to power, increased purchase and use of electrical devices. Tariff incentives being implemented for electric heating to reduce air pollution also drive up power use, and the use of LPG stoves in soum centers is assumed to increase as well.

Decreases in appliance energy intensity and carbon intensity, as most appliances become gradually more efficient, following international trends. Lighting, too, declines in energy intensity, with a slow trend toward the use of more efficient fluorescent and compact fluorescent bulbs. An ongoing ger district clean air program with efficient stoves and the use of cleaned coal is being implemented and leads to modest declines in the energy and carbon intensity of cooking in the ger district. The energy

¹⁸ Based on the United Nations Medium projection for population, which is close to the projection in МОНГОЛ УЛСЫН ХИН АМЫН 2008–2030 ОНЫ ХЭТИЙН ТООЦОО, dated 2008

intensity of heating declines gradually as the building energy efficiency provisions of the Building Law, Housing Law, and Urban Planning Law of Mongolia are implemented (Energy Charter Secretariat, 2011), and as some existing housing is better insulated and new units built are better insulated than in the past, applying the results of building energy efficiency pilot programs such as the GEF/UNDP Building Energy Efficiency Project.

Countervailing trends in heating energy intensity, as trends towards better insulation in households are offset by increases in thermal comfort and higher average indoor temperatures. In the commercial sector, new buildings tend to have more glass area, which contributes to greater heating needs in the winter (due to poor insulation value) and increased cooling needs in the summer (due to higher solar gain). At present, the intensity of consumption per unit building volume of the main fuels for the commercial and other sector are assumed to grow at 2 percent (heat and heating fuels) and 3 percent (electricity) annually, reflecting a combination of a trend toward more comfortable buildings and the use of more electric devices. Figure 6-1 presents overall energy demand in the buildings sector in the reference scenario. Urban household energy use dominates energy demand in the buildings sector, which is projected to nearly double, overall, between 2010 and 2035, despite the combination of energy efficiency improvements and ongoing shifts away from less-efficient biomass heating fuels.

Figure 6-1. Energy demand in the buildings sector in the *reference scenario*

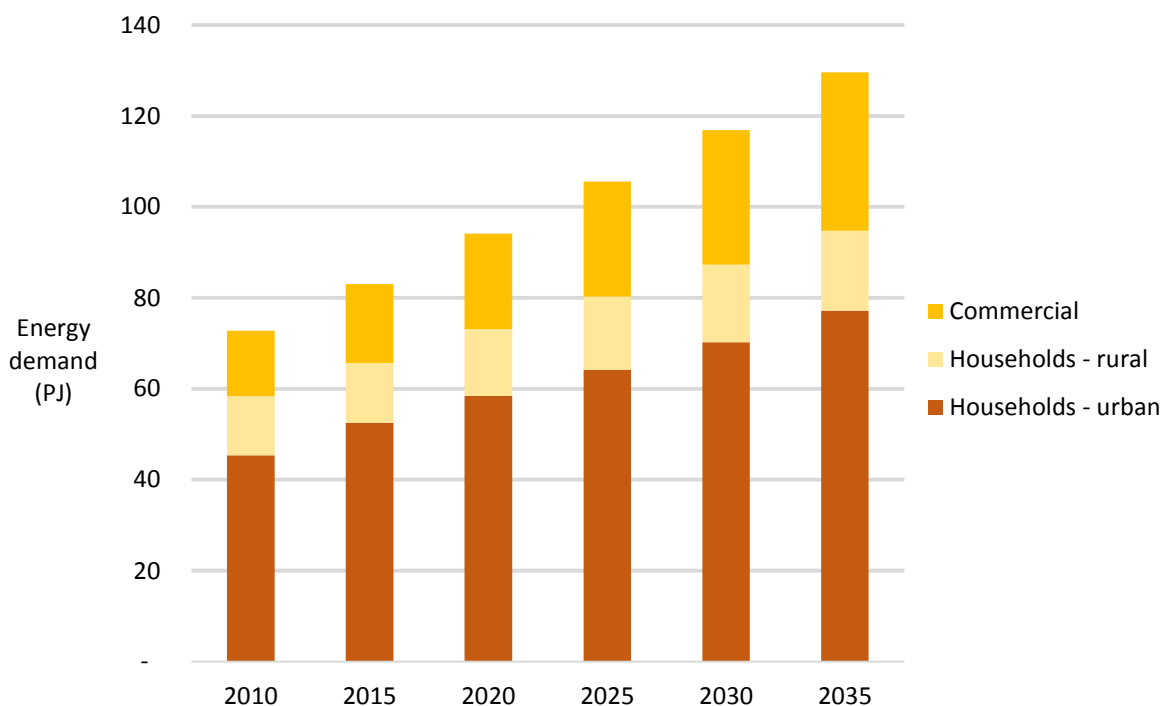

6.3 Recent plans scenario

The recent plans scenario largely follows the reference case in the buildings sector, with the exceptions that it includes building energy efficiency—improvements in building envelopes—and lighting efficiency improvements, both of which are part of recent policies proposed for the sector. These improvements are implemented in both the households and commercial subsectors. Figure 6-2 shows the trend in energy demand in the buildings sector. Relative to the reference case, year 2035 energy demand is reduced in this scenario by 20%.

Figure 6-2. Energy demand in the buildings sector in the *recent plans* scenario

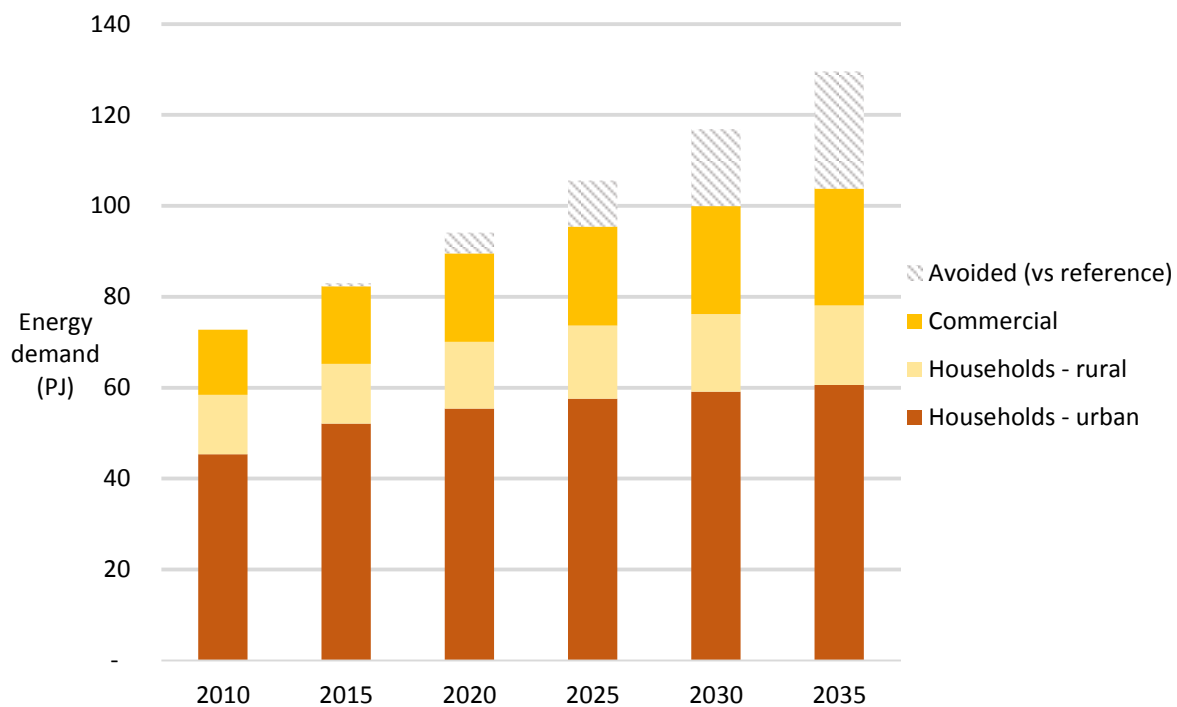

6.4 Expanded green energy scenario

In the expanded green energy scenario, trends in population, urbanization, household size, appliance use, and scale of commercial development mirror the reference case. Improvements in heating and electric power efficiency, however, are greater but do not necessarily counterbalance growth in average household size or appliance use. In some cases, notably for heating requirements and many appliance categories, a downward trend in *per household* energy demands results as improved building-insulation and appliance efficiency outweigh increased living space and appliance ownership.

Within the commercial sector, increases in energy demand are dampened relative to the reference scenario, decreasing on a per cubic meter of building volume basis. However, the rapid expansion of infrastructure continues to drive up the overall heat and power required by commercial buildings through 2035.

The major departures from the reference scenario modelled are:

Energy retrofits of existing apartment buildings proceed rapidly, with retrofits starting in 2014 and proceeding at an annual rate of roughly 5% of the building stock, such that all of the remaining existing buildings are retrofit by 2035. Due to better insulation and air sealing, these retrofit buildings require 29% less heat per household (Fraunhofer IBP 2008). **Improved insulation of apartment buildings was identified as one of the top priorities in MEGD's *Technology Needs Assessment* (MEGD 2013b).** Furthermore, phase-in of heat metering allows further reduction of heat demand by 20% per household by providing a clear incentive to not over-heat, as has been achieved in industry and service sector buildings (MNET 2010). As the members of the building trade in Mongolia become more familiar with measures for improving the energy efficiency in buildings, both the annual rate of conversion of the building stock and the improvement in efficiency could increase beyond what has been included in the expanded green energy scenario, as the savings rate above is based on the results of a relatively limited case study.

Higher energy standards for new apartment buildings take effect in 2014 with better compliance rates, decreasing the thermal energy demands by 28% for all new apartment buildings compared to reference (UNDP 2007). Higher energy standards for new buildings would build upon the provisions of the Building Law, Housing Law, and Urban Planning Law. As with retrofit buildings, introduction of heat metering saves an additional 20% per household (MNET 2010).

Transition to high-efficiency appliances and lighting for all grid-connected residential and commercial buildings occurs with more aggressive deployment than in the reference scenario, achieving reductions in electricity demand of 25% for residential and 21% for commercial buildings relative to the reference scenario, similar to that achieved for Russia in the IEA's 2DS scenario (IEA 2012a).

Demand for fuel for heat in urban *ger* districts decreases 40% per household (ADB 2008; MEGD 2013) by 2035 through increased use of efficient stoves and better insulation (blankets). For cookstoves, efficient coal stoves replace existing coal stove technology at a rate of 2% per year starting in 2015, with an associated 40% improvement in energy efficiency per stove (Arc Finance 2012; MEGD 2013).

Heating and coal demand in the commercial sector is reduced by 28% through a combination of increased efficiency standards, higher compliance with the standards, and building retrofits starting in 2015 at a rate of about 5% per year. The amount of heat and fuel savings is consistent with the improved building standard and enforcement (UNDP 2007) and retrofits (Fraunhofer IBP 2008), while

contributions from increased use of heat metering devices (MNET 2010) can help accomplish the demand reductions.

Figure 6-3 presents building energy use in Mongolia in the expanded green energy scenario. Relative to the reference case, year 2035 demand is reduced in this scenario by over 35%.

Figure 6-3. Energy demand in the buildings sector in the *expanded green energy* scenario

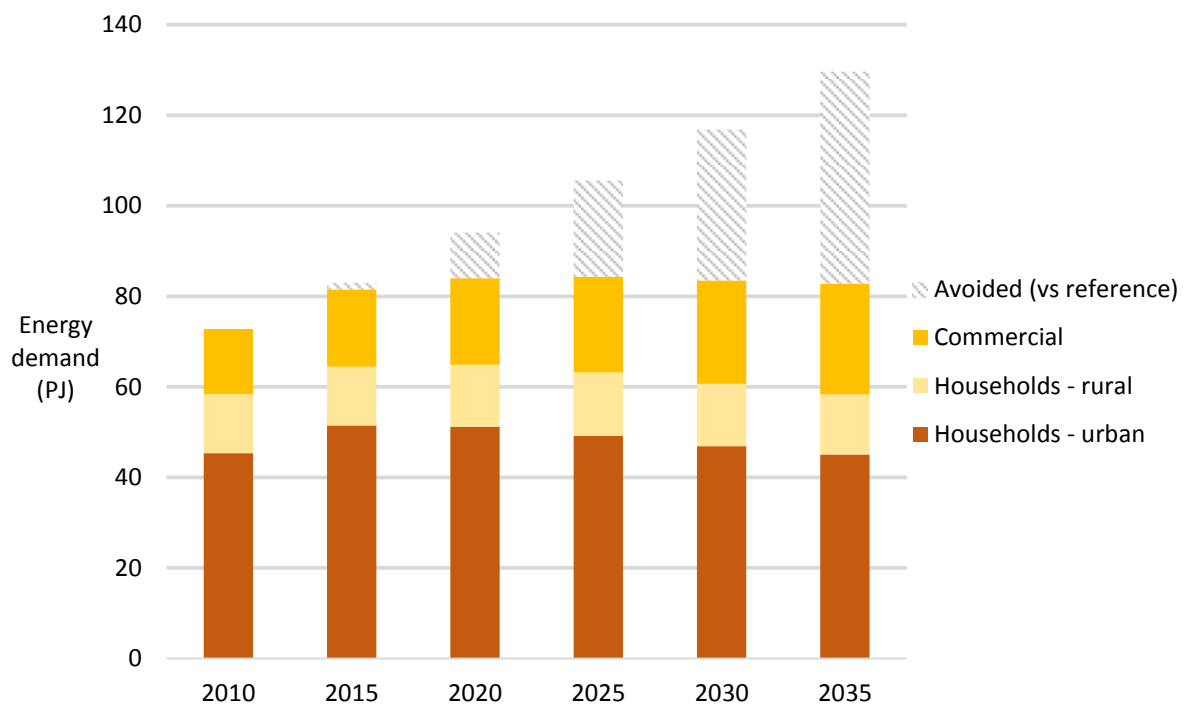

Box 6-1: Considerations for Natural Gas for Heat in Mongolia

Mongolia does not have significant natural gas reserves, and so energy planning in Mongolia has not generally included serious consideration of natural gas for power or heat supply. Future imports of natural gas, either via pipeline (perhaps from Russia) or by rail as liquefied natural gas (LNG), remains a possibility, however (Maidowski 2012), and natural gas (as CNG) has some momentum as a fuel for buses in Ulaanbaatar (GGGI 2013). Furthermore, it is possible that in-country sources of methane (e.g., coal mines, animal wastes) could supplement (or, perhaps, substitute for) sources of imported natural gas, at least for some smaller applications.

Gas could potentially be deployed as a heating fuel in Mongolia, whether as used in dedicated boilers, in CHP, or directly to buildings (e.g., in UB's ger districts, if distribution infrastructure was developed). Several factors may need to be considered in evaluating this potential:

- Costs of transmission and distribution infrastructure (and, if applicable, collection infrastructure, e.g. for methane from animal wastes)
- Greenhouse gas or other pollutant benefits per unit of gas. Given that quantities of natural gas (or methane) are likely to be constrained in Mongolia, it may be advisable to use the gas where societal benefits are the greatest, e.g. where each unit of natural gas has the greatest air pollution or greenhouse gas emissions benefit. This may tend to favor use of gas in centralized power or heat (or CHP) applications where the efficiency benefit of gas (compared to alternative fuels) may be the greatest.
- “Upstream” or “life-cycle” GHG balance of gas relative to alternative fuels; though the GHG emissions of combusting natural gas are much less (per unit of energy obtained) than coal, when leaks in production and transport infrastructure are considered, the GHG benefits of natural gas can be much less, or (according to some researchers) eliminated. Furthermore, other means of providing heat (such as ground source heat pumps) may be able to yield (particularly in the long term) much greater GHG savings at comparable costs.

The scenarios in this study do not include new natural gas infrastructure, due to lack of a domestic resource and lack of significant import capacity.

6.5 Discussion and possible initiatives

The *expanded green energy scenario* indicates that the potential for increased energy efficiency in buildings is significant – perhaps reducing energy intensity by 35% in 2035 relative to the reference case scenario, for a total energy savings of nearly 47 PJ. This finding, in turn based largely on a number of studies by Mongolia’s international partners, suggests that a greater focus on end-use energy efficiency may be needed in the country. A number of initiatives already exist, involving the Mongolian government and outside partners such as the Global Environment Facility, UNDP, GIZ, and others. Still, Mongolia’s Ministry of Energy has no formal national energy efficiency priorities and policies (Minchener 2013), unlike for renewable energy. As will be explored further in Chapter 8, energy efficiency is often the most cost-effective means of meeting goals for reductions in GHG emissions or other pollutants, and it may deserve more attention.

To support the realization of energy efficiency’s potential to reduce the need for future power plants, bring energy savings to consumers, and reduce GHG and other emissions, the Mongolian Ministry of Energy, together with partners at the Ministry of Environment and Green Development and Ministry of Road, Transportation, Construction and Urban Development, may consider developing a more formalized framework for building energy efficiency, such as a national energy efficiency or energy conservation law. Such a law has been considered in Parliament before, but not yet passed as of January 2014. A new law could set out energy efficiency goals and priorities, much like the 2007 Renewable Energy Law did for renewable electricity. Perhaps as part of such a law (or as individual initiatives), Mongolia could develop:

- An expanded program, perhaps coupled with financing, to retrofit existing buildings, and expanding on existing programs such as those focused on pre-cast apartment buildings in UB and the wider distribution of ger blankets.
- Appliance efficiency standards to ensure that appliances and other electronics, use of which is rapidly expanding in Mongolia, meet stringent standards. Policy templates and assistance is available from a number of international organizations, including the Collaborative Labeling & Appliance Standards Program (CLASP) and the Super-efficient Equipment and Appliance Deployment (SEAD) Initiative. This initiative could be developed and implemented by some combination of the Ministry of Energy, Ministry of Environment and Green Development, and the Mongolian Agency for Standard and Measurement. Currently, the Ministry of Energy is preparing a draft of an energy efficiency law that would establish an energy conservation committee to implement energy efficiency standards and other measures in energy consumers.
- A stringent building energy code to ensure that future residential and commercial/institutional buildings are efficient. Given the rate of growth of Mongolia’s economy, coupled with ongoing urbanization, buildings that are yet to be built may comprise

a significant fraction of all building energy demand in the reference case in 2035, suggesting the importance of standards that minimize the energy intensity of these buildings while avoiding “locking in” poor thermal performance. This standard could be developed and implemented by the Ministry of Road, Transportation, Construction and Urban Development with assistance from the Mongolian Agency for Standard and Measurement under the Deputy Prime Minister.

As in other sectors, further research and data development could also be beneficial. (See section 11.3 for a list of possible follow-on research and initiatives.)

7 Transport

7.1 Sector Overview

Transportation activity has been expanding in Mongolia, both passenger and freight travel. In particular, there has been a strong trend towards increase in the number private passenger vehicles, with rates of private vehicle ownership over 15 times higher in 2010 than they were in 1990 (National Statistical Office of Mongolia 2012). Passenger travel has increased from 980 passenger-kilometers (pkm) per person in 1990 to 1,200 pkm in 2010. Freight transport has increased from 3,300 tonne-kilometers (tkm) per person in 1990 to 4,400 tkm in 2010, with large majority by rail (National Statistical Office of Mongolia 2012). Table 7-1 lists assumptions regarding key drivers for the reference scenario.

Table 7-1. Key Drivers, Transport Sector

Driver	2010	2015	2020	2025	2030	2035
Passenger transport (thousand pkm/resident)	1.3	2.2	3.0	4.0	5.1	6.2
Road	0.5	1.1	1.8	2.5	3.2	4.0
Rail	0.4	0.5	0.4	0.4	0.4	0.4
Air	0.3	0.6	0.8	1.1	1.4	1.7
UB Subway	0.0	0.0	0.0	0.1	0.1	0.1
Freight transport (thousand tkm/resident)	4.4	5.6	7.2	9.1	11.7	14.9
Road	0.7	1.6	2.1	2.9	3.9	5.2
Rail	3.7	4.0	5.0	6.3	7.8	9.7
Air	<0.1	<0.1	<0.1	<0.1	<0.1	<0.1

7.2 Reference scenario

In the reference scenario, expansion of private passenger travel continues, and although some improvements are expected, efforts to reduce transport energy use are assumed to be modest in scale. The reference scenario is also characterized by the following trends.

Continued increase in personal travel, as passenger kilometers travelled increase with population growth, and with a roughly five-fold increase in travel per person by 2035 relative to 2010, following recent trends tempered with consideration of a maturing economy. Based on data from IEA 2012, these estimated trends for passenger-km per person by 2035 yield roughly half of that projected for China and about 40 percent of the total in Russia over the same time frame. Over time, a greater fraction of passenger transport is by private cars (40% of passenger-kms in 2020 and 49% in 2035, up from 25% in 2010) and air (a 27% by 2020, maintained through 2035, up from 21% in 2011). A subway in UB starts service in 2022, providing 2% of passenger-kms.

Continued increase in freight travel, to support increasing consumption of goods and industrial activity. Freight transport per capita is assumed to increase by an average of 5 percent annually, with road freight continuing to gain ground on rail, transporting 35 percent of tonne-kms by 2035 (up from 15 percent in 2010).

Gradual decline in energy intensity of vehicles, following forecast international trends (IEA 2012a), for both passenger (declining about 1% per year for cars, 0.5% per year for buses) and freight vehicles (declining 0.4% per year).

Figure 7-1 shows the reference case trends in energy demand in the transport sector, respectively, by subsector. Freight road transport dominates (using diesel fuel), much of it related to coal and minerals production.¹⁹

¹⁹ Electricity use in vehicles is included only for expansion of the existing urban trolley system in the reference case, but the reference case also includes new electric train transport in the form of the planned Ulaan Baatar subway system, which is assumed to come into operation in 2022.

Figure 7-1. Energy demand in the transport sector in the *reference* scenario

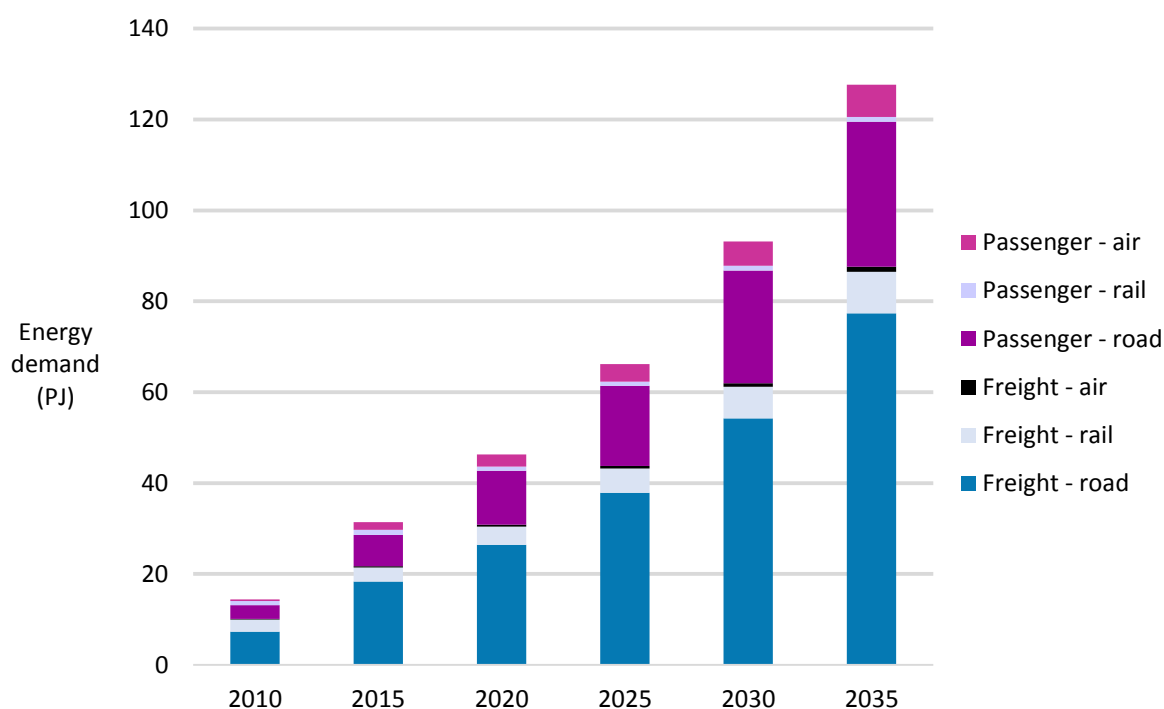

7.3 Recent plans scenario

The recent plans scenario is the same as the reference scenario for the transport sector, since the Ministry of Energy and Ministry of Environment and Green Development do not have significant new plans for efficiency improvements in this sector.

7.4 Expanded green energy scenario

In the expanded green energy scenario, passenger-kilometers travelled are the same as in the reference scenario, but Mongolians make a greater share of the trips by buses and trains and use even more-efficient vehicles, including (over time) hybrids and electric vehicles. Overall freight demand is similar, but declines slightly in the expanded green energy scenario as less coal is used for power generation, and therefore freight demand is somewhat lower.

Expansion of bus rapid transit (BRT) service in Ulaanbaatar combined with streamlined system operations leads to a higher proportion of passenger travel by bus, with a mode share of road

transport increasing from 40% presently to 43% in 2020, compared to a drop to 33% in 2020 in the reference scenario. This is consistent with GGGI's transport study (GGGI 2013).²⁰

Greater adoption of energy-efficient vehicles, including hybrids for both passenger and freight vehicles, with highly efficient internal-combustion and hybrid vehicles comprising 25% and electric vehicles 4% of the road passenger and freight fleet by 2035 (up from 0% in the reference scenario), roughly tracking the potential market for these vehicles in nearby Russia but somewhat behind that in China (IEA 2012a). In the green energy scenario, electric vehicles consume roughly one-quarter the energy of the equivalent liquid fuel vehicles (IEA 2009)²¹.

Partial conversion of bus fleet to compressed natural gas (CNG) buses, with the transition of 20% of the bus fleet to CNG between 2014 and 2020, consistent with the maximum CNG conversion scenario in GGGI's transport study (GGGI 2013). (For additional discussion of CNG vehicles, see Box 7-1.)

Increased use of rail for passenger and freight transport, as rail transport provides twice the share of passenger-kms in 2035 (12% of passenger-kms) as in the reference scenario (6%), with the majority of the shift from road travel and some from air travel. In this scenario, rail still comprises a much lower *share* of passenger travel in 2035 (12%) than it does currently (34%) due to rapid growth of personal vehicle travel, though overall rail travel does climb, from 440 pkm per person in 2010 to 740 pkm per person in 2035. In freight transport, use of rail increases relative to the reference scenario, comprising 94% of tonne-km in 2035, compared to 90% in the reference scenario (both of which are a decrease from 97% mode share in 2010, due to continued growth of road freight transport.)

Figure 7-2 and shows trends in energy demand by vehicle type in the expanded green energy scenario. Features of these results relative to the reference case include markedly lower overall energy use (nearly 39 percent by 2035), and a very modest shift in fuel types away from petroleum products to electricity and, to a lesser extent, natural gas.

²⁰ GGGI's Transport study, assumed, in a medium case, that 15% of personal vehicle travel in UB switches to buses. Fifteen percent of car mode share in the reference scenario of 67.5% is 10% and is therefore the difference between the bus mode share in the reference scenario in 2020.

²¹ This comparison refers to end-use energy consumption, and does not include conversion or transmission and distribution losses associated with electricity use.

Figure 7-2. Energy demand by vehicle type in the transport sector in the *expanded green energy* scenario

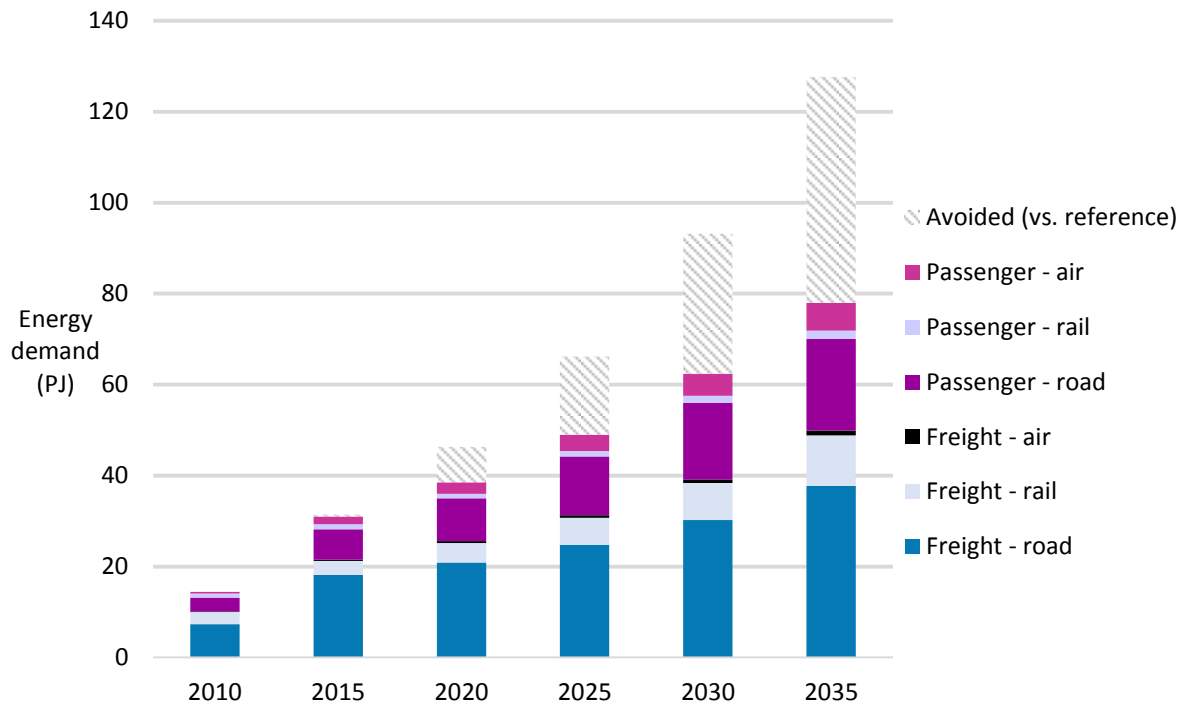

Box 7-1: Considerations for CNG Vehicles

Urban areas, including Ulaanbaatar, are sometimes drawn to compressed natural gas (CNG) vehicles as a means to improve local urban air quality. Compared to gasoline or diesel, CNG yields fewer particular air pollutants and nitrous oxides per unit of energy, and in some cases existing vehicle stock can be converted. CNG also produces less carbon dioxide emissions from combustion than does gasoline or diesel. However, whether converting vehicle fleets from gasoline or diesel to CNG would reduce greenhouse gas emissions is an open question. CNG is made primarily of methane (CH₄), which itself is a potent greenhouse gas, many times more potent than carbon dioxide. If the process of producing and delivering natural gas, plus operating the CNG vehicle, leaks even a small amount (e.g., 3%) of natural gas, the net effect of CNG vehicles could actually be to *increase* global greenhouse gas emissions (Alvarez et al. 2012). The expanded green energy scenario converts, in the short term, 20% of the buses in Ulaanbaatar to CNG, consistent with the recent GGGI transport study (GGGI 2013). In the long term, the expanded green energy scenario introduces electric vehicles. Decarbonization of transport fuels could also be accomplished with low-GHG biofuels, if such fuels exist, or fuel cell vehicles, if they are developed.

7.5 Discussion and possible initiatives

In the reference scenario, transporting people and goods demands nearly as much energy in 2035 as do buildings or industry, though it grows at the fastest average rate (averaging 9% per year for both freight and passenger transport through 2035). This rapid growth rate indicates the importance of energy efficient and low-carbon transport in meeting Mongolia's GHG reduction goals. Furthermore, mobility of people, materials (e.g. coal and copper), and consumer goods is likely to be a critical factor in maintaining economic growth in the country.

Energy use for transportation is dominated by road transport vehicles (cars and trucks). Results of the expanded green energy scenario suggest that the three primary strategies to reduce transport energy demand all have significant effects. These are: (1) avoid and shorten trips, especially through urban planning that allows for proximity of services and employment to residents; (2) shift trips to other modes, such as bus, rail, and non-motorized modes; (3) increase the efficiency of vehicles (including adoption of electric vehicles in the long term).

Although a detailed assessment of policy options is beyond the scope of this study, experience in other countries suggests that the following policies may need to be strengthened in Mongolia, and building on the country's existing national transport strategy:

- National guidelines for urban planning, and combined land use and transportation planning, to plan for growth and transportation systems in urban areas that minimizes the need for personal vehicle travel. This may include guidelines on specific types of policies, such as parking requirements or road system planning, which can encourage public and non-motorized transit or dissuade personal vehicle travel.
- Policy support for expanded public transportation, both inter-city rail and for public transportation within major urban areas, especially UB, and perhaps including a national strategy on moving people and goods that includes significant expansion of rail capacity.
- Enhanced vehicle efficiency or emissions standards. More stringent fuel economy standards, or CO₂ emissions standards, could be implemented for vehicles in Mongolia, or enforcement of existing regulations enhanced. These could build on Mongolia's existing taxes based on CO₂-intensity and engine size and set long-term targets to give vehicle sellers greater certainty (GGGI 2013).

The Ministry of Road, Transport, Construction, and Urban Development would be a natural lead for these types of efforts. The Ulaanbaatar city government could play an important role in guidelines for urban planning and combined land use and transportation planning. The Ministry of Environment and Green Development would implement CO₂ emission standards. And, although the discussion here focuses primarily on road transport, the use of air transport is also increasing rapidly, and as air transport is typically more energy intensive, per passenger-km, than other passenger transport modes, policies or programs implemented to discourage flying or promote alternatives (such as long-distance rail transport) could result in reductions in overall energy use. At the same time, some have suggested that increasing some air travel (that of in-bound tourists) could perhaps contribute to green development – this possibility is discussed further in Box 7-2.

Box 7-2: Tourism as green growth?

Increasing tourism is sometimes discussed as a potential source of economic growth in Mongolia. Increasing the number of visitors could increase spending at hotels, restaurants, retailers, travel and tour providers, and other businesses, with secondary effects for the broader economy. The extent that tourism would be green growth depends on one's perspective. In the context of energy planning, one of the key metrics to assess a potential green growth initiative is greenhouse gas emissions.

Most energy and greenhouse gas emissions associated with tourism are from air travel (UNWTO and UNEP 2008). Whether increasing tourism in Mongolia would increase or decrease global GHG emissions depends on who is travelling to Mongolia and where else they otherwise might have travelled. For example, if a European traveler were to travel to Mongolia instead of to another destination in Europe, global GHG emissions may increase because of the further transport distance. On the other hand, if a Chinese traveler were to travel to Mongolia instead of to southeast Asia, air travel could be shorter and global GHG emissions could decrease.

Another perspective could be whether increasing tourism in Mongolia may yield a greater increase in GDP per unit of GHG emissions than alternative development paths, such as increased mining. Based on global economic data compiled from the Global Trade and Analysis Project, the GHG-intensity (per unit of economic value) of travel is not significantly different than mining coal or copper, however – both yield, on average, about 2 kg of CO₂e per dollar of economic value (Hertwich and Peters 2010). The GHG-intensity of tourism could be decreased if the tourism involved greater expenditures in low GHG-intensity activities, such as recreation activities within Mongolia that do not depend heavily on additional travel.

8 Industry: Mining and Manufacturing

8.1 Sector overview

Exploration of fossil and mineral resources has proceeded rapidly in Mongolia, especially for coal and copper, for which production is now poised to grow four-fold by the end of this decade (IMF 2012). Copper extraction is poised to be a major driver of economic growth in Mongolia, due in large part to the Oyu Tolgoi copper and gold mine, which contains an estimated 25 million tonnes of copper and 1,100 tonnes of gold (Temuulen 2010). The mine, situated in the south Gobi region, is also expected to be a large electricity user, due to the demands of ore processing equipment such as crushers, grinders, and separators, as it ramps up production in the next few years.

The territory of Mongolia may contain as much as 160 billion tons of coal resources (USGS 2012; Baatar 2012; Minchener 2013; BGR 2013). By far the largest single deposit of economically recoverable coal reserves is the Tavan Tolgoi deposit, with an estimated 7.5 billion tons of mineable reserves of bituminous hard coal (Minchener 2013).

Mongolia also has significant iron ore, gold, and crude oil resources, and production of these commodities may also be poised to grow rapidly in the coming years (Eurasia Capital 2011). Domestic crude oil is mainly exported to China, however plans exist for Mongolia's first refinery, which could largely rely on Russian crude inputs (Oxford Business Group 2013). Further opportunity remains to extract and refine Mongolian crude within the country, and two additional smaller refineries have been discussed (Maidowski 2012).

In addition to these primary resources, other resource industries will also grow in Mongolia: iron and steel production, cement production, and a host of other secondary industries. Though each demands less overall energy than does mining, together they still comprise a significant fraction of Mongolia's energy demand.

Table 8-1. Key Drivers, Industry Sector lists assumptions regarding key drivers for the industry sector assumed for all scenarios.

Table 8-1. Key Drivers, Industry Sector

Driver	2010	2015	2020	2025	2030	2035
Copper (Million tonnes)						
Oyu Tolgoi	0.00	0.20	0.55	0.55	0.55	0.55
Erdenet	0.12	0.12	0.12	0.12	0.12	0.12
Coal (Million tonnes)						
Tavan Tolgoi	9	22	40	45	50	50
Other	15	26	30	35	38	41
Crude oil (Million barrels)	2.2	4.4	4.4	4.4	4.4	4.4
Iron Ore (Million tonnes)	3.2	6.5	7.5	7.5	7.5	7.5
Gold (Tonnes)	6.0	20.7	20.7	20.7	20.7	20.7
Cement (Thousand tonnes)	323	1,348	2,500	3,506	4,475	5,188
Steel and iron (Thousand tonnes)	126	161	205	262	334	427

8.2 Reference scenario

In the reference scenario, production of most commodities increases rapidly, with energy intensity declining gradually due to installation of new, more efficient equipment.

Copper. The Oyu Tolgoi mine produces 200,000 tonnes of copper in its first full year (2014), rising to roughly 500,000 tonnes in 2017, increasing to 550,000 tonnes in 2019, and holding constant through 2035 (IMF 2012; Temuulen 2010). Production at Mongolia’s other copper mines, especially Erdenet, continues at about 120,000 tonnes of copper annually. The energy intensity of copper mining holds relatively constant, as Mongolia’s copper mines follow historical patterns of gradually decreasing ore quality as the richer deposits are mined first²², and lower ore content results in higher energy intensity per ton of ore (Norgate and Haque 2010). The increased energy intensity from mining of lower ore quality offsets improvements mining, hauling, and processing technologies. Energy requirements per ton of concentrated of copper ore are higher for Erdenet copper mining than for Oyu Tolgoi due to the higher quality ore content of the Oyu Tolgoi mine (Fisher et al. 2011).

Coal. Tavan Tolgoi rapidly increases output, to 35 million tonnes in 2017 (IMF 2012), after which output growth levels off somewhat, rising to 50 million tons in 2030. Output of other coal mines increases from about 15 million tonnes per year in 2010 (National Statistical Office of Mongolia 2012) to 35 million tonnes per year by 2017 (IMF 2012) and over 40 million tonnes by 2035.²³ The energy

²² See, in the case of Mongolia, decreasing ore quality at Erdenet between 2007 and 2011 (http://www.erdenetmc.mn/index.php?option=com_content&view=article&id=57%3Atechnic&catid=37%3Aindicator&Itemid=55&lang=en) as well assumed reduced ore quality by Fisher et al. (2011).

²³ Growth rates in output decline over time, in part due reduced issuance of licenses for exploration and production over time—including a recent decrease in exploration permits from 50% to 20% of Mongolia’s land area—based on “wise exploitation of minerals”, and more control over the mining sector.

intensity of coal mining holds constant in the reference scenario, as gains in the efficiency of equipment are offset by gradually increasing difficulty in extracting coal and/or, in the case of electricity use, increased use of electricity for mining processes.

Crude oil. The planned oil refinery in Darkhan (jointly owned by Marubeni Corp and Toyo Engineering) starts producing in late 2015, at a capacity of 44,000 barrels per day and produces refined products roughly in proportion to existing in-country demand, which is consistent with stated annual production goals of one million tonnes of diesel fuel, 630 thousand tonnes of gasoline, and 60 thousand tonnes of jet fuel.²⁴ Planning is also underway for another refinery in Sainshand, though that refinery is not included in the reference scenario due to uncertainty about its feasibility (Maidowski 2012). Domestic crude oil output grows from about 2.2 million barrels per year in 2010 to 4.4 million barrels per year in 2015²⁵. Alternative projections for crude oil output from the literature (Eurasia Capital 2011) suggest continued strong growth in crude oil output at least into the 2020s, but these estimates were judged to be unrealistic by Advisory Committee members. The energy intensity of petroleum refining holds constant in the reference scenario, with an average efficiency of 95%. It is expected, based on input from the Advisory Committee that, due to geographical considerations, crude oil extracted in Mongolia will continue to be exported, and oil refining in Mongolia will use crude oil imported from Russia.²⁶

Iron ore. Production of iron ore expands from just over 3 million tonnes in 2010 to 7.5 million tonnes in 2020, remaining at that level thereafter.

Gold. Mining for gold continues to accelerate, growing by a factor of three between 2010 and 2015, but then remaining steady out to 2035. As with copper and iron ore mining, increasingly lower grade ore quality serves to cancel out decreased energy intensity from improved technology, leaving energy intensity essentially unchanged through 2035 in the reference scenario. Mining intensities are based on US DOE (2007), IEA (2007), and Mudd (2007).

²⁴ See, for example https://www.marubeni.com/dbps_data/news/2010/100929f.html

²⁵ Projections of crude oil production capacity/output for 2015 and on are based on Advisory Committee input received 10/2013.

²⁶ A recent announcement indicates that HBOil JSC, an oil trading and refining company based in UB, has acquired a 20 percent stake in an existing oil refinery in North Korea, near that nation's border with Russia and China. It is unclear how the Mongolian company intends to provide crude oil for the refinery, which was built with assistance from the Soviet Union in the 1970s) when and if it is brought back on line (the refinery has been mostly idle for nearly 20 years), or where the products the refinery would produce would be sent, although it has been suggested that petroleum products trades involving the Russian Far East could be a possible mechanism for supplying fuels from the project to Mongolia. See, for example, Bloomberg Sustainability (2013), "Mongolia Taps North Korea Oil Potential to Ease Russian Grip", by Michael Kohn and Yuriy Humber, dated June 18, 2013, and available as <http://www.bloomberg.com/news/2013-06-17/mongolia-taps-north-korean-oil-potential-to-ease-russia-reliance.html>.

Steel and iron production is assumed to increase at 5 percent annually through 2035 with constant per unit energy demand. Modest improvements in energy intensity of output for both electricity (-0.5%) and coal heat (-0.3%) are achieved in the reference scenario, consistent with recent historical energy intensity decline (worldsteel 2011; IEA 2011).

Cement output increases from 426,000 tonnes in 2011 to 2.5 million tonnes in 2020, and then at a slower rate of growth (as the economy matures and growth in the building sector slows) to 5.2 million tonnes in 2035. Modest improvements in energy intensity of output for both electricity (-0.5%) and coal heat (-0.3%) are achieved in the reference scenario.

Construction, following a decrease in output in 2009 during the global recession, resumes its strong growth, with sectoral GDP increasing from 343 million dollars in 2010 to nearly 2.7 billion dollars in 2035. Growth in the construction sector is assumed to gradually slow over time, as the Mongolian economy matures and population growth declines. As in other industrial sectors, modest improvements in the energy intensity of output for both electricity (-0.5%) and coal heat (-0.3%) are achieved in the reference scenario, with the intensity of other fuels use (diesel, gasoline, and bitumen/asphalt) remaining steady at 2010/2012 levels.

Other, secondary industry outputs grow in a manner consistent with recent trends. Energy intensities slowly decrease (at the same rate as for steel and iron and cement manufacturing).

Figure 8-1 and Figure 8-2 show growth in energy consumption by subsector and by fuel, respectively, for the industrial sector. Electricity use in the sector jumps with the increase in copper output from 2014-on, with electricity initially coming from imports from China (starting in 2013), and later from the Tavan Tolgoi power plant²⁷.

²⁷ Before 2013, electricity for Tavan Tolgoi was reportedly generated on-site using large diesel-fueled generation units.

Figure 8-1. Energy demand by subsector type in the industrial sector, *reference* scenario

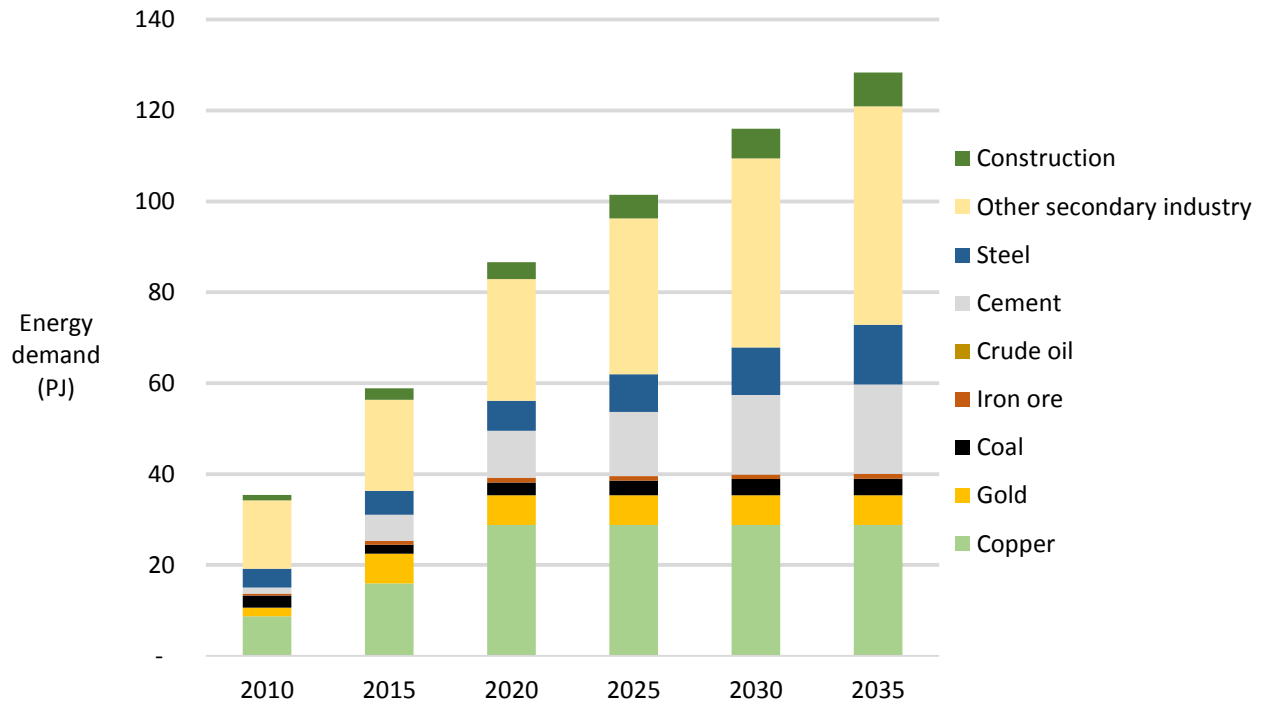
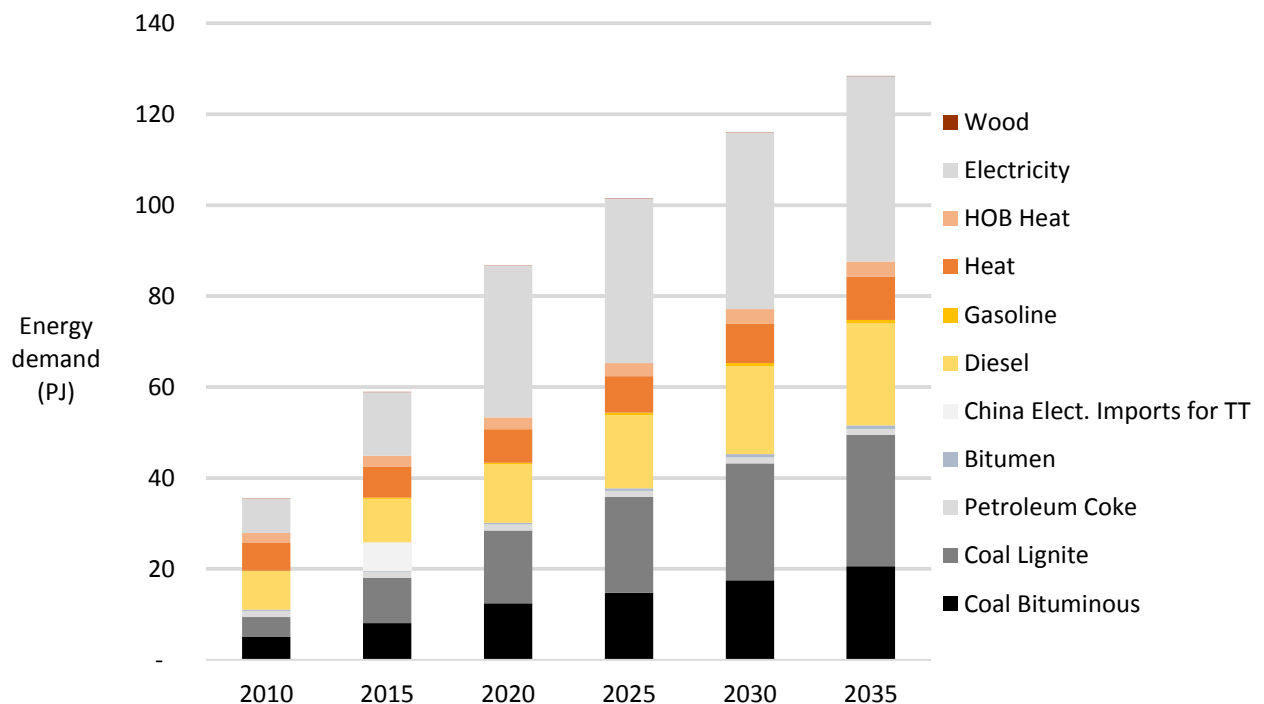

Figure 8-2. Energy demand by fuel in the Industrial sector, *reference* scenario



8.3 Recent plans scenario

Assumptions for the industrial sector for the recent plans scenario are the same as for the reference scenario.

8.4 Expanded green energy scenario

In the expanded green energy scenario, industrial production volumes match those in the reference scenario, but industries transition to very low energy-intensity technologies, in some cases reaching (current) practical minimum intensities by 2035.

Copper. In the expanded green energy scenario, copper mining operations are conducted with even more energy efficient equipment, especially in the long term. Compared to reference case levels (which are assumed, given the relative newness of the equipment), to be similar to current world “best practice” levels, energy intensity in 2035 reaches practical minimum levels, estimated here to be 42% less electricity and 30% less diesel than in the reference case (US DOE 2007). These energy efficiency improvements are phased in from 2020 on.

Coal. The efficiency of mining operations improves substantially with improved equipment and technology use for extraction, materials handling, and beneficiation and processing (which includes crushing and grinding and separations). In this scenario, coal mining demands approximately 15% less electricity and 30% less diesel in 2020 than in the reference scenario (US DOE 2007). By 2035, continual upgrades to reduce energy intensity even further, with energy intensity reaching practical minimum levels – 48% less electricity and 48% less diesel compared to the static reference case (US DOE 2007).²⁸

Crude oil refining. Petroleum refining steadily realizes improvement in energy efficiency, to reach best available technology (Saygin et al. 2011) levels by 2035, which reduces energy intensity by about 50%, and increases efficiency to roughly 97.5%.

Iron ore. In this sector, mining equipment also reaches practical minimum energy intensities in the long term: 1% savings between 2014-2020 and an additional 21% savings by 2035 relative to the reference case (Norgate and Haque 2010).

Gold: Gold mining energy intensities undergo the same relative improvements as copper mining, reaching practical minimum energy intensities by 2035 (US DOE 2007). Savings relative to the static reference scenario are 27% by 2020 and 58% by 2035 for electricity, and 20% by 2020 and 45% by 2035 for diesel demand versus the reference scenario.

²⁸ Planned, but not yet implemented in the modeling of the green energy scenario, are coal-bed and coal-mine methane capture and usage to reduce greenhouse gas emissions associated with coal mining. Further research is needed to determine the applicability of these options to the predominantly open-cast coal mines in Mongolia.

For steel and iron, and cement, uptake of energy efficiency technologies and practices reduce electricity demand by 10% in 2020 and 28% in 2035 relative to the reference scenario, driven by mainly by implementation of improved electric motors and drive systems, with additional demand reduction from improvements in lighting and other industrial end uses, and a shift from vertical shaft to horizontal shift kilns in cement production. Demand for solid fuels and heat, decline 10% by 2020 and 30% by 2035 relative to the reference scenario, primarily from introduction of higher-efficiency boilers and furnaces and more efficient end use of heat.

All secondary and other industries, undergo the same reductions in electricity demand and solid fuel requirements as cement and steel and iron, driven by implementation of similar industry wide technologies.

Figure 8-3 and Figure 8-4, respectively, show energy demand by fuel type and by industrial subsector under the expanded green energy scenario. As a result of efficiency improvements, overall energy demand in 2035 is 29 percent less than in the reference case, and overall industrial energy use, though more than twice 2010 levels, grows only slowly after 2020.

Figure 8-3. Energy demand by subsector type in the industrial sector, *expanded green energy scenario*

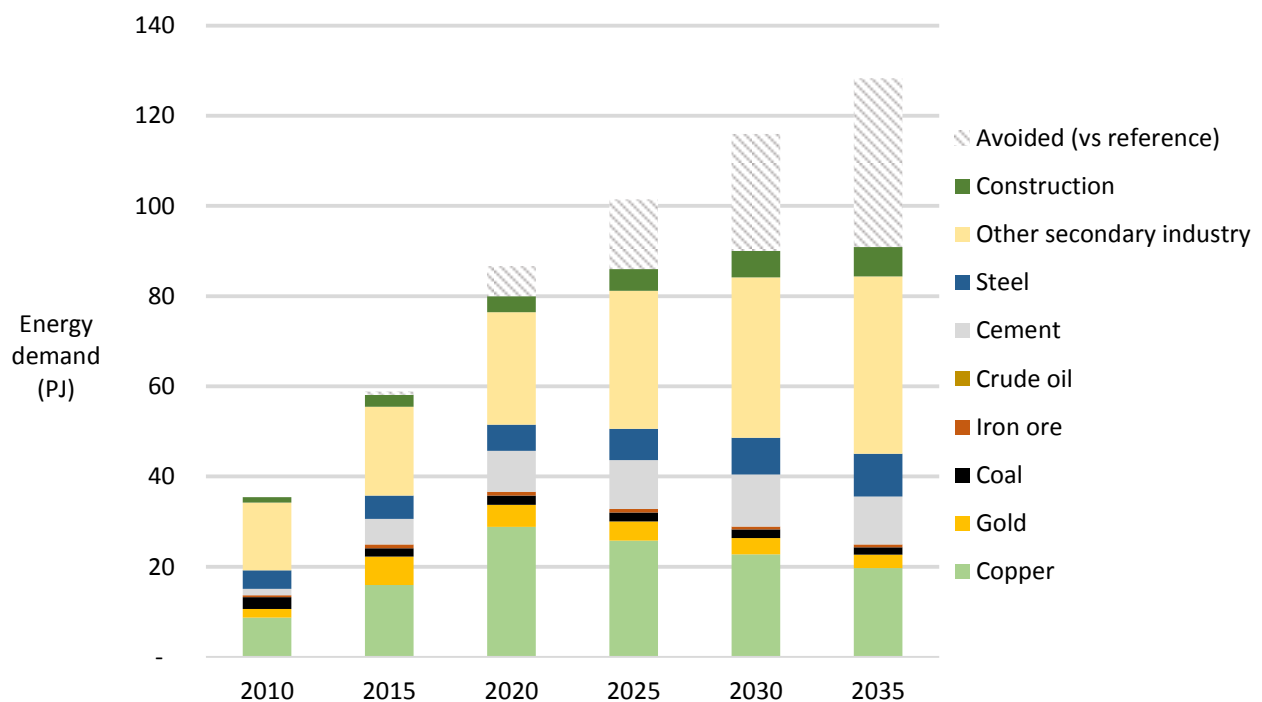
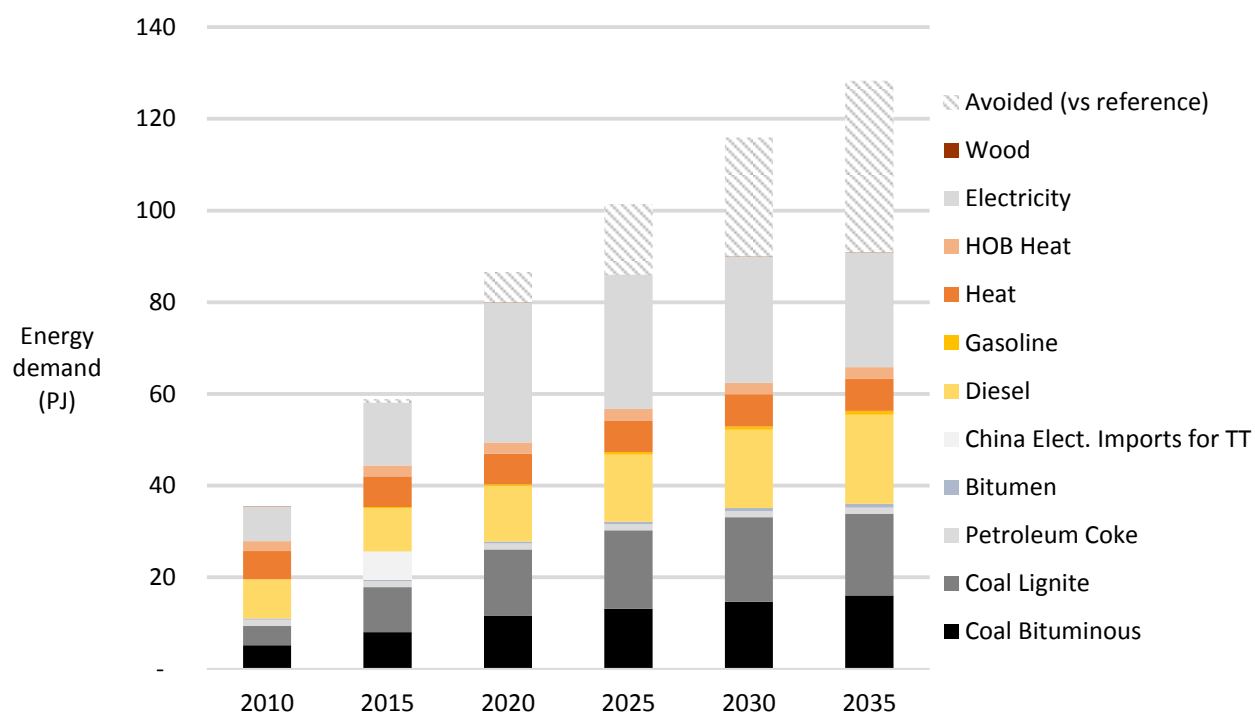

Figure 8-4. Energy demand by fuel in the industrial sector, *expanded green energy scenario*



8.5 Shifts in energy export scenario

Although mining activity is expanding rapidly, the Mongolian government also realizes that the economy has become perhaps too dependent on mining exports, and it has been evaluating means of diversifying its economy (UNIDO and Government of Mongolia 2011; Minchener 2013; Enkhbayar 2013; Oxford Business Group 2013). The Ministry of Economic Development (which, following the 2012 general election and subsequent restructuring, replaced the Mongolian National Development and Innovation Committee) is tasked with developing economic development priorities. The Ministry of Environment and Green Development, a “core” ministry that reports directly to the prime minister and is responsible for the country meeting environmental standards, has also recently been assessing the opportunity for “green development”, including developing draft targets for growing the share of other (non-mining) industrial sectors, agriculture, and tourism in Mongolia’s economy (MEGD 2013a).

Furthermore, plans to rapidly increase exports of coal depend on continued high Asian demand for coal, especially from China, and on Mongolia being able to compete in those markets. While high demand for coal seems relatively certain in the near term, in addition to risks from typical cyclical price variations, other risks to the long-term coal outlook for Mongolia may present themselves, such as the prospect of competition from low-cost coal from other areas (such as from the USA or Indonesia) (Minchener 2013). Furthermore, if major world economies were to move decisively

towards creating a low-carbon economy, demand for coal – both thermal and metallurgical coal -- could decrease, leaving countries that depend heavily on exports of fossil fuels at greater risk for reduced competitiveness (Vivid Economics 2009; IEA 2013). In the words of OECD Secretary Angel Gurría,

“If policy makers cap carbon emissions, the risk of ‘unburnable assets’ could have a significant impact on the valuation of some companies...The fact is that any new fossil resources brought to market – conventional or unconventional – risk taking us further away from the trajectory we need to be on, unless there is a firm CCS requirement in place or governments are prepared to risk writing off large amounts of invested capital. A very strong tide is what we call ‘carbon entanglement’. What does this mean? Basically, that governments everywhere on behalf of their citizens have major stakes in bringing fossil fuel to market and taking their share of the rents.....Carbon entanglement will not be easily undone and the very modest progress of climate policy over the last two decades is in part testament to that. These are some of the strongest tides that we have to confront.”

This further suggests the need for Mongolia to diversify its economy going forward, which could have implications for domestic energy demand (and associated greenhouse gas emissions).

The shifts in energy export scenario maintains coal mining to meet domestic needs, but substitutes export of renewable electricity for export of coal while maintaining overall economic activity. Accordingly, energy demand associated with coal mining declines proportionally.

In principle, this scenario would also maintain crude oil refining to meet domestic needs, but gradually substitutes export of renewable electricity for export of crude oil while maintaining overall economic activity. However, because crude oil exports are expected to be just a small fraction of coal exports, they are not included in the calculations for this scenario.

8.6 Discussion and possible initiatives

In the reference scenario, demand for energy in Mongolia’s industrial sector increases more than in any other sector, overtaking buildings as the country’s most significant energy user within the next few years, and continuing a steady increase through this study’s time period. Energy demand from the mining sector – especially for copper and gold – is particularly significant, and is driven by energy use for loaders, excavators, shovels, grinders, crushers, and fans (for ventilation), even though some stakeholders have indicated that new mining operations are installing the newest, most energy-efficient equipment. Other major sources of energy demand in industry include in cement kilns (for producing clinker) and various pumps, drives, and motors used in a variety of secondary manufacturing facilities.

Though Mongolia's industry sector uses energy in a wide variety of end-use technologies, the concentration of energy demand in a few key sectors and technologies may present opportunities for policy influence. For example, the Mongolian government could perhaps:

- Implement energy standards on particular pieces of widely-used technologies, such as the different types of mining equipment listed above, cement kilns, and industrial motors. These could be developed by the Ministry of Energy and the Ministry of Industry and Agriculture (heavy industry policy implementation Department) and also Ministry of Environment and Green Development.
- Implement energy or emissions performance standards that could encompass all energy use or emissions associated with production of particularly energy-intensive and homogenous products. For example, the government could require production of copper concentrate to release less than a particular quantity of CO₂ emissions (including indirect emissions associated with electricity use) per ton of copper concentrate. A possible alternative, or supplemental, approach could be to create a tradable CO₂-intensity standard where industrial facilities that did not meet the standard could purchase credits from other facilities that exceeded it. This unique approach has been developed and applied for numerous industrial sectors in India, where it is called the "Perform, Achieve, Trade" system. The Ministry of Environment and Green Development could take the lead in emissions performance standards.

9 Agriculture

9.1 Sector overview

Mongolia's agricultural output has been and is still driven strongly by livestock production, with about three-quarters of output (on an economic basis) being from livestock, the remainder from crops.²⁹ Traditionally, livestock production has required relatively limited amounts of commercial energy (oil products, coal, and electricity), although in recent years herders have adopted greater use of gasoline-powered vehicles, including motorcycles, for herding of animals, and a program of providing solar PV power for herding households has been very successful.

²⁹ A relatively small amount of output is also derived from the forestry sector, and corresponding energy use is included here under agriculture. Mongolia's forest resources are mostly in the north of the country, estimated at 15.2 million hectares (Statistical Yearbook, 2011), with wood stocks of 1.2 billion cubic meters

9.2 Reference scenario

In the reference scenario, it is assumed that the area cropped in Mongolia, which has been relatively small in the past (as livestock production has dominated the sector) increases rapidly over time, increasing 5-fold by 2035. This assumption is consistent in direction with the Mongolia Development Institute data indicating increased hectares of cereals (wheat and potatoes) and other field crops. Relatedly, there is a trend in Mongolia to expand production of fodder in order to stabilize food for livestock from year to year, and reduce the need to cull herds (as well as livestock deaths) in years when natural pasture productivity is inadequate. There will also be a trend toward increased concentration/intensification of livestock production for milk and meat production. This will result in more used of electricity, for example, for dairy, pig, and poultry farms, whereas traditional livestock-raising emphasizes production of goats and sheep. The use of diesel is for general farm machinery, as well as in “pud-pud” diesel tractors, which are used to generate power for on-farm use as well as for field use. Used as generators, these devices are not particularly efficient at producing electricity. It is assumed that current intensities of fuel use per unit of area cropped will continue to hold through the end of the modelling period, as improvements in device efficiency are balanced by more use of mechanized equipment.

In the forestry subsector, the future growth rate of commercial wood harvests is assumed to be 3%/yr through 2020 (roughly consistent with recent experience), declining to 2%/yr by 2030.

Figure 9-1 and Figure 9-2 show reference case energy demand by fuel and by subsector, respectively. Fuel use is dominated by gasoline use for motorcycle herding, though it must be emphasized that the estimate of this use of fuels is a rough approximation.

Figure 9-1. Energy demand by subsector in the agriculture sector, *reference scenario*

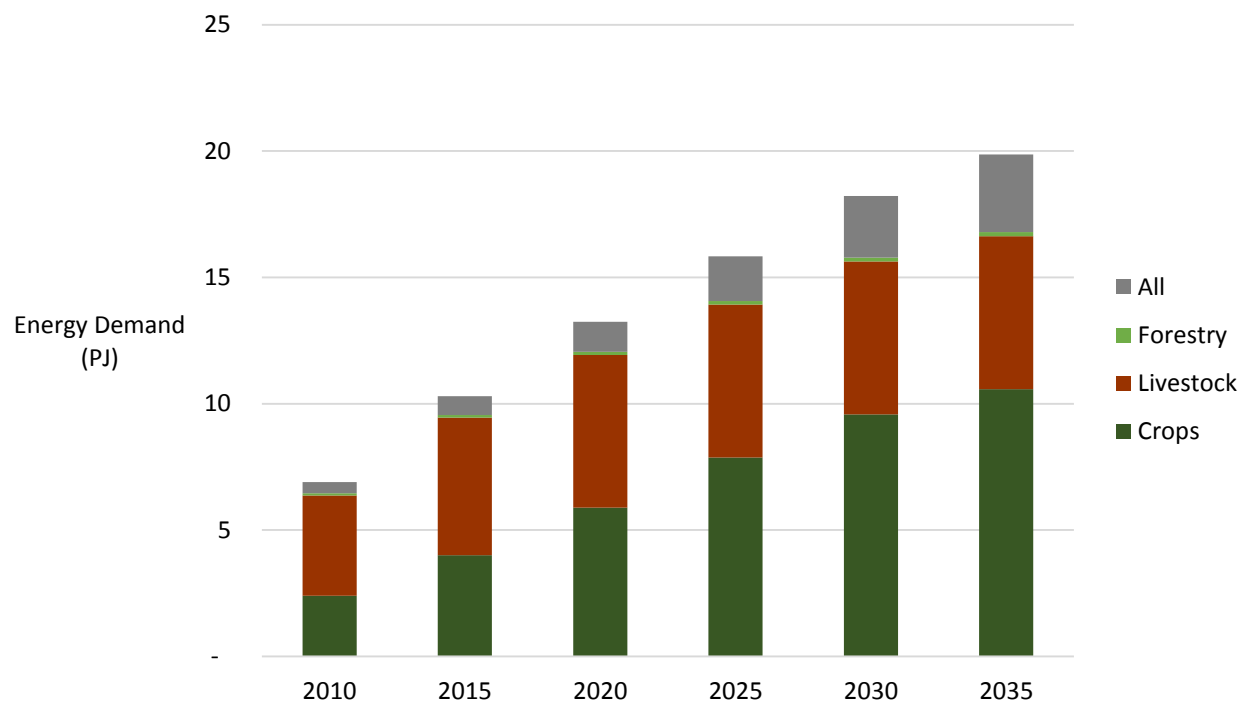
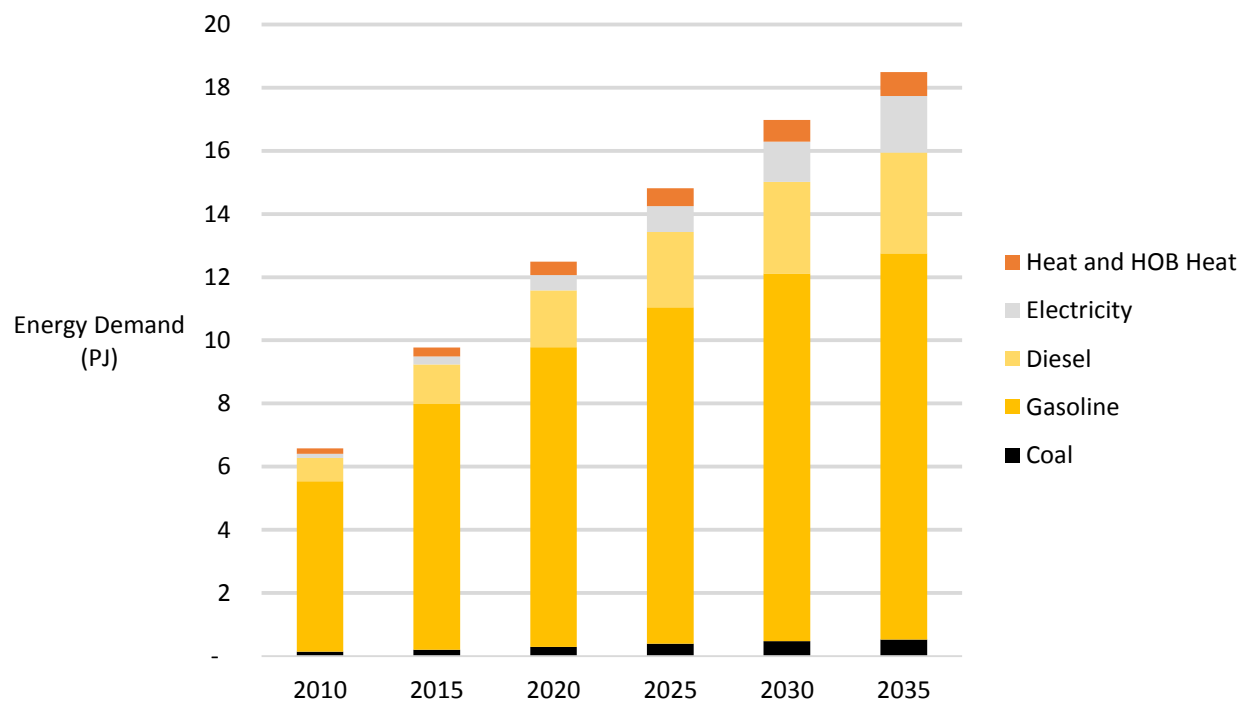

Figure 9-2. Energy demand by fuel type in the agriculture sector, *reference scenario*



9.3 Expanded green energy scenario

The *expanded green energy scenario* sees improvements in the energy efficiency of electric pumps and other electrical devices of 28% by 2035, similar to those modelled for the industrial sector.³⁰ These improvements lead to a modest reduction in overall energy use in the agriculture sector of 2.5 percent by 2035. (Given this small reduction, no graphs are presented here.)

9.4 Discussion and possible initiatives

Agriculture has traditionally been a mainstay of the Mongolian economy and cultural identity, and will continue to be, even as other economic sectors, most notably mining, grow rapidly. Though the sector is not a major energy user (consuming about 5% of the country's energy), it may grow more energy-intensive over time if agricultural practices become more centralized and mechanized. Expanding agriculture may also be a strategy to maintain diversity in Mongolia's economy, bringing another source of growth alongside the mining industry, though accessing regional or global markets may be more difficult than for mineral commodities. (For other considerations on if and how agriculture may contribute to green growth, see Box 9-1.)

Efforts to develop policy initiatives to reduce agricultural energy use in Mongolia would require more detailed data, suggesting that collection of data on energy use, and on trends affecting energy use, in the agricultural sector, would be particularly helpful,³¹ as may be surveys of livestock production practices (including on trends toward centralized production facilities) or renewable energy pilots (including for biogas from animal wastes as well on application of solar PV or wind systems, possibly with energy storage, for remote farming applications).

³⁰ Additional reductions in agricultural sector GHG emissions could be possible through diesel engine efficiency improvements, and if methane capture was implemented at more mechanized and centralized livestock facilities. Given lack of detailed data, these options were not modeled at this time.

³¹ Collection and analysis of this type of information could be the focus, for example, of one or a pair of coupled doctoral theses, or of a sponsored research program, possibly in conjunction with a program to follow-up recent efforts to encourage herder families who move from pasture to pasture to adopt solar photovoltaic power systems.

Box 9-1: Local Agriculture as Green Growth?

Mongolia currently imports about 200,000 tonnes of food annually, about two-thirds of which is flour, sugar, and fruit (National Statistical Office of Mongolia 2012). If feasible, producing more of these commodities locally could contribute to economic growth. Whether increasing agriculture would contribute to green growth is a matter of perspective. Field and tree crops such as these do not generally require significant energy or cause significant GHG emissions per ton of product, at least compared to energy-intensive commodities such as steel or petroleum products. At the same time, these crops are also relatively low value, and so GHG intensity per dollar may not be substantially different than for the economy as a whole (Hertwich and Peters 2010). Supposing that half of these crops could be grown locally, and assuming an average price of 0.50 USD per kg, growing more of these crops could potentially add USD 50 million annually to Mongolia's economy. The global GHG impact would depend, however, on whether Mongolia could grow these crops with more or fewer carbon-intensive energy sources than the countries from which Mongolia currently imports food, as well as the relative energy associated with transporting the food to markets in Mongolia. Growing and bringing to markets agricultural products in Mongolia in ways that reduce energy use in greenhouse gas emissions relative to food imports may be difficult for some crops, such as fruit, that depend on warmer climates.

Another strategy to increase local agriculture could be to increase production of existing agricultural products that are not imported at high rates (and in some cases may be exported), such as mutton, goat, beef, milk, wool, and cashmere. Meat from ruminant animals such as sheep, goats, and cattle, however, are among the highest-GHG (per kg) foods (Weber and Matthews 2008), and compared to other economic sectors are also among the highest products in terms of GHGs per dollar of value (Hertwich and Peters 2010), due in large part to the high releases of methane (CH₄) from these animals. That said, producing more of these commodities in Mongolia for export could conceivably reduce global GHG emissions if they could be produced with fewer GHG emissions than in alternative locations of production.

PART III. OVERALL RESULTS, CONCLUSIONS, AND NEXT STEPS

10 Overall Scenario Results

The project team has developed and evaluated three major scenarios for the evolution of the energy sector in Mongolia. The reference scenario represents “business as usual” for Mongolia, in terms of both growth in driving activities—such as population, GDP growth, and output of industrial products—and in terms of trends in energy intensities—the amount of energy used to heat a home, produce a tonne of cement, or move a passenger a kilometer. The reference case also continues to rely primarily on coal-fired systems to supply power and heat for the energy users of Mongolia. The recent plans scenario uses the same driving activities as the reference case, but includes building energy efficiency and lighting energy efficiency in the buildings (household and commercial/institutional) sector, and implements new, large hydroelectric facilities to diversify the resources use for power production. The expanded green energy scenario incorporates a collection of energy efficiency measures throughout the economy, together with the aggressive implementation of electricity generation from renewable resources, and some earlier retirement of older coal-fired facilities. A special case of the expanded green energy scenario, the shift in energy exports case, replaces exports of coal with exports of electricity from renewable resources.

Table 10-1 presents overall scenario results for the first three scenarios in terms of electricity generation, overall energy demand, and GHG emissions.

Table 10-1. Electricity generation, energy demand, and GHG emissions in three scenarios

Variable and Scenario	2010	2015	2020	2025	2030	2035
Electricity generation, GWh						
Reference scenario	4,591	6,865	14,006	15,953	18,084	20,283
Recent plans scenario	4,591	6,857	13,961	15,757	17,745	19,571
Expanded green energy scenario	4,591	6,747	13,027	13,431	13,927	14,508
Overall energy demand, TJ						
Reference scenario	133	189	248	298	356	419
Recent plans scenario	133	188	243	288	339	393
Expanded green energy scenario	133	186	223	244	265	285
Greenhouse gas emissions, M t CO_{2e}						
Reference scenario	16	20	37	43	49	56
Recent plans scenario	16	20	35	38	43	49
Expanded green energy scenario	16	20	27	28	27	28

Below we summarize additional results of the first three scenarios with regard to electricity generation, energy demand, and GHG emissions.

10.1 Electricity generation

Table 10-2 summarizes electricity output by scenario for the three main scenarios evaluated. By 2035, generation in the recent plans case is 3.5 percent lower than in the reference case, while the suite of energy efficiency measures, plus some supply-side efficiency measures, in the expanded green energy scenario reduces overall generation requirements by over 28 percent. The reference case output from renewable energy systems is just over one percent by 2035, while the recent plans case includes nearly 11 percent renewables generation by 2035, and the expanded green energy case includes over 46 percent renewable power.

Table 10-2. Electricity output in the reference recent plans, and expanded green energy scenarios, TWh

Variable and Scenario	2010	2015	2020	2025	2030	2035
Electricity generation, GWh						
Reference scenario	4,591	6,865	14,006	15,953	18,084	20,283
Recent plans scenario	4,591	6,857	13,961	15,757	17,745	19,571
Expanded green energy scenario	4,591	6,747	13,027	13,431	13,927	14,508
% as renewables						
Reference scenario	1%	4%	2%	2%	1%	1%
Recent plans scenario	1%	4%	4%	14%	12%	11%
Expanded green energy scenario	1%	4%	31%	35%	42%	46%

10.2 Energy demand

Overall energy demand by fuel grouping in the reference, recent plans, and expanded green energy scenarios are shown in Figure 10-1, Figure 10-2, and Figure 10-3. Overall, the recent plans case reduces energy use in 2035 relative to the reference case by 6%, while the expanded green energy case reduces overall energy demand by 32%.

Figure 10-1. Overall energy demand by fuel group, *reference* scenario

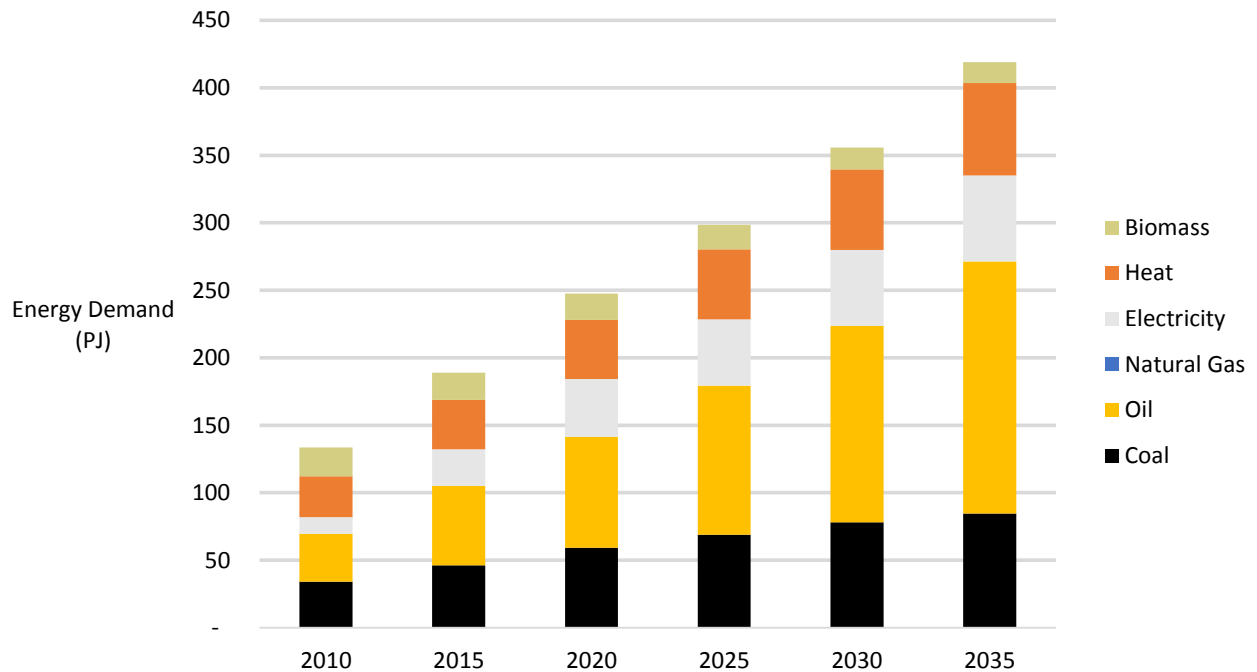

Figure 10-2. Overall energy demand by fuel group, *recent plans* scenario

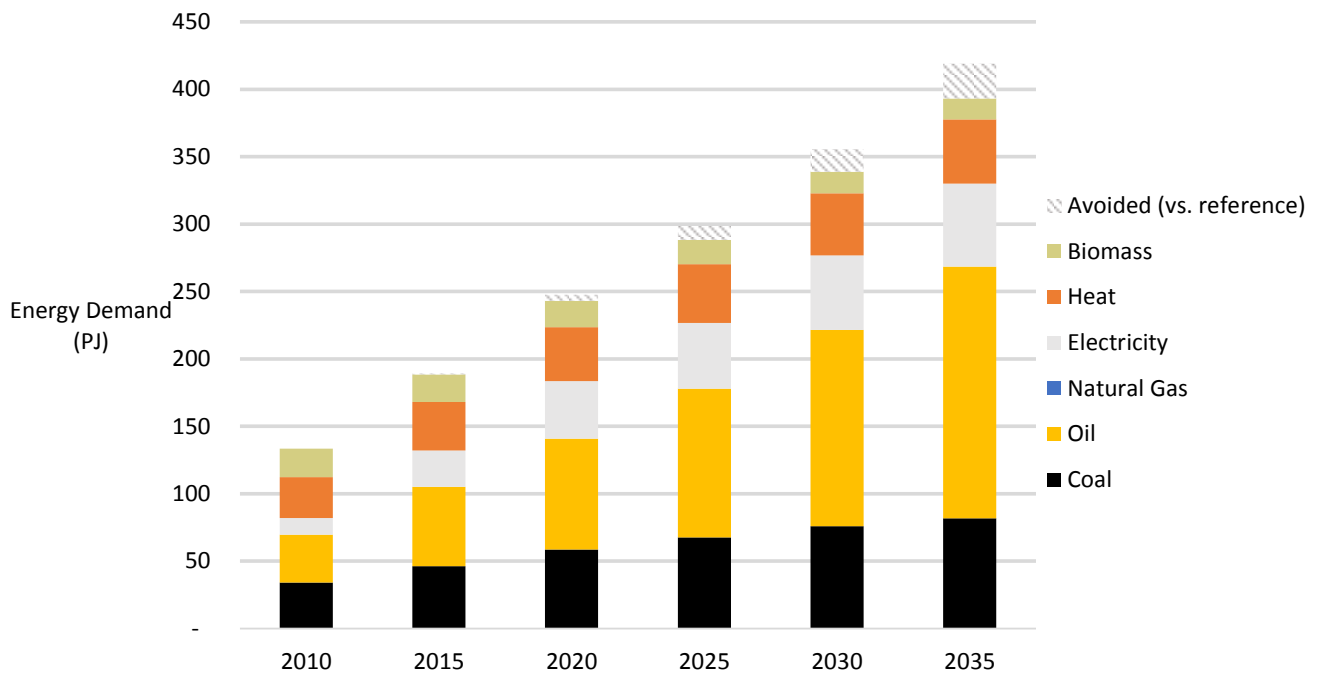

Figure 10-3. Overall energy demand by fuel group, *expanded green energy scenario*

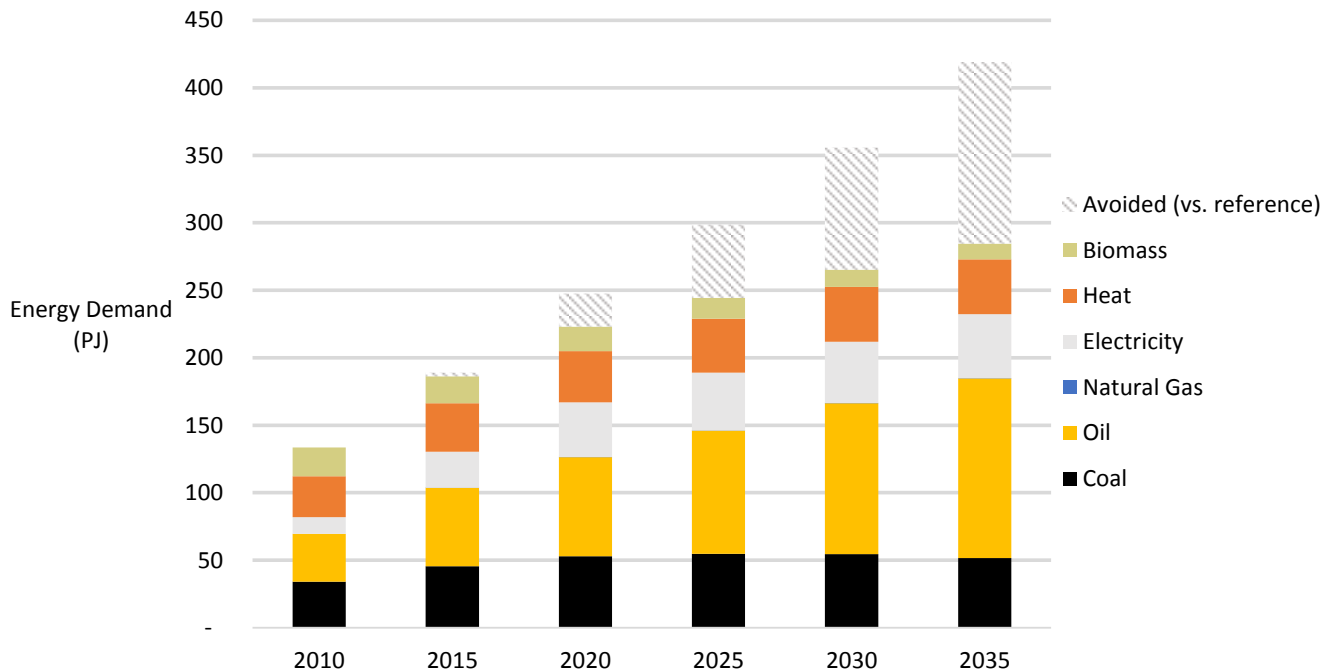

Figure 10-4, Figure 10-5, and Figure 10-6 each focus on electricity demand in one of the three major scenarios (not counting the shift in energy export scenario). Here, the combination of measures in the recent plans case reduce 2035 electricity demand by 3.5% relative to the reference case, while the more extensive suite of options in the expanded green energy case reduce overall 2035 electricity demand by 27%, despite the addition of some electricity demand, relative to the reference case, in the buildings (for ground-source heat pumps) and transportation sector.

Figure 10-4. Electricity demand by sector, *reference* scenario

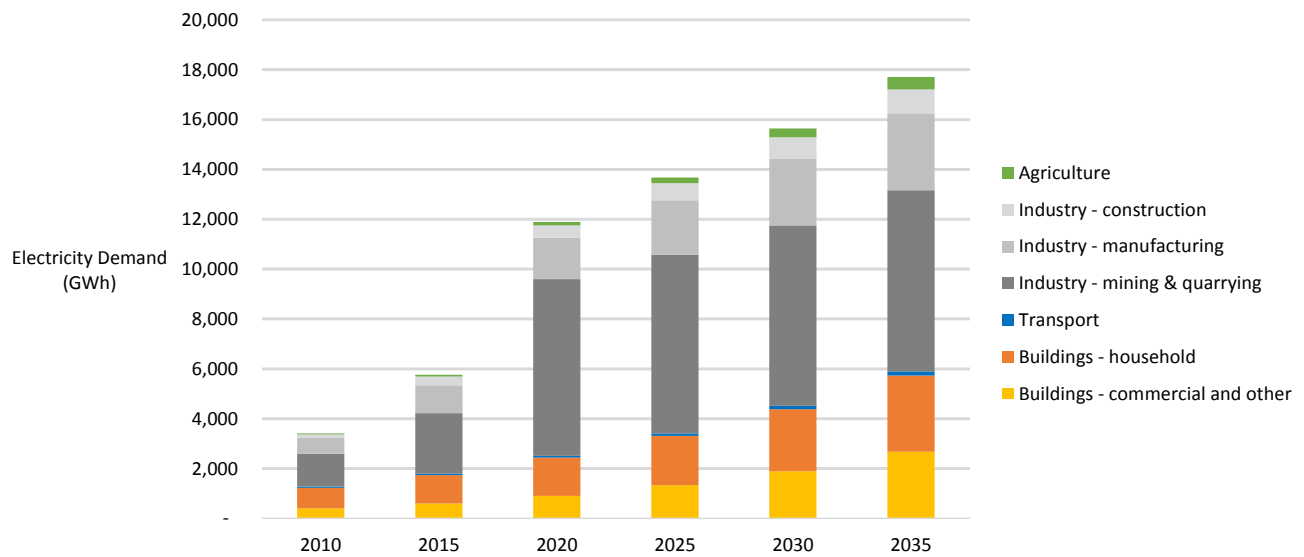

Figure 10-5. Electricity demand by sector, *recent plans* scenario

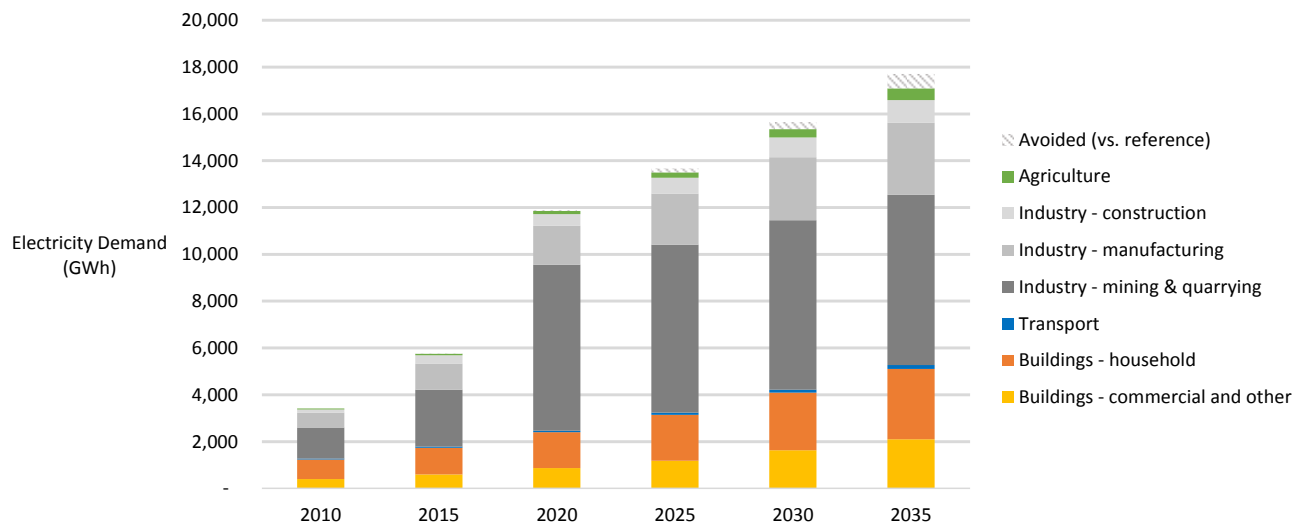
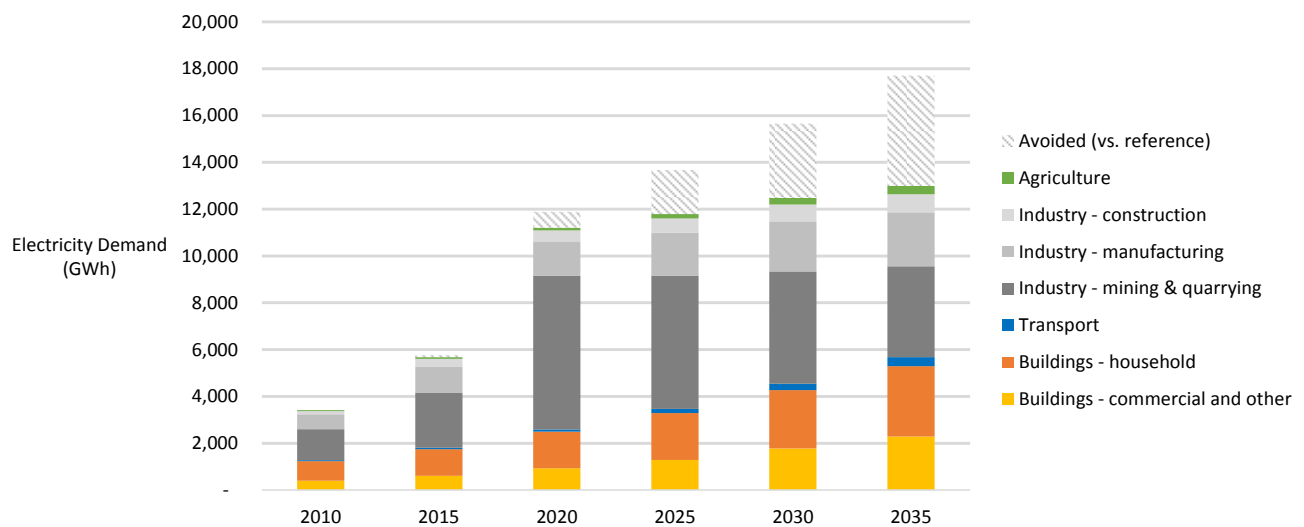

Figure 10-6. Electricity demand by sector, *expanded green energy scenario*



10.3 Greenhouse gas emissions

Figure 10-7 and Figure 10-8 show reference case GHG emissions, respectively, by sector and by fuel. (In these charts, GHG emissions are shown on a “territorial” or “production” basis, or the emissions that would be released within Mongolia.) Electricity generation (including combined heat and power) produces the largest share of GHGs throughout the modeling period, with emissions from coal comprising over three quarters of Mongolian GHG emissions until 2035. Overall GHG emissions rise to about 56 million tonnes of carbon dioxide equivalent by 2035. Figure 10-9 and Figure 10-10 show results for the recent plans scenario. Overall GHG emissions in the recent plans scenario are 49 MTCO_{2e} by 2035. As shown in Figure 10-11 and Figure 10-12, expanded green energy scenario emissions by sector and fuel are half of reference case emissions by 2035, with the most significant reductions being in the electricity generation sector (whether due to energy efficiency or renewable energy), but with reductions throughout the economy. Measures with at least 2 million tonnes of GHG abatement potential are (from higher to lower potential): energy efficiency improvement in the mining sector, energy efficiency in other industrial sectors, wind power, hydropower, appliance efficiency, and transport mode shift to rail. The high potential for these first five measures is not surprising, given the rapid growth in the mining and other industrial sectors, the dominance of GHG emissions from power supply, and the growth in appliance and electronics usage in urban areas (especially UB). The high GHG abatement potential from mode shift in the transport sector is surprising and interesting, however, and derives in large part from the assumption that transport demand will grow rapidly in Mongolia (about 5% per year) and that most of that new demand will be in road transport. If transport activity does not grow that fast, overall energy use, GHG emissions, and emissions abatement potential may be less in the transport sector than indicated here. (For a more

detailed discussion of the GHG abatement potential of each major category of measures, see Chapter 9's discussion of cost-effectiveness).

Figure 10-7. GHG emissions by sector, *reference scenario*

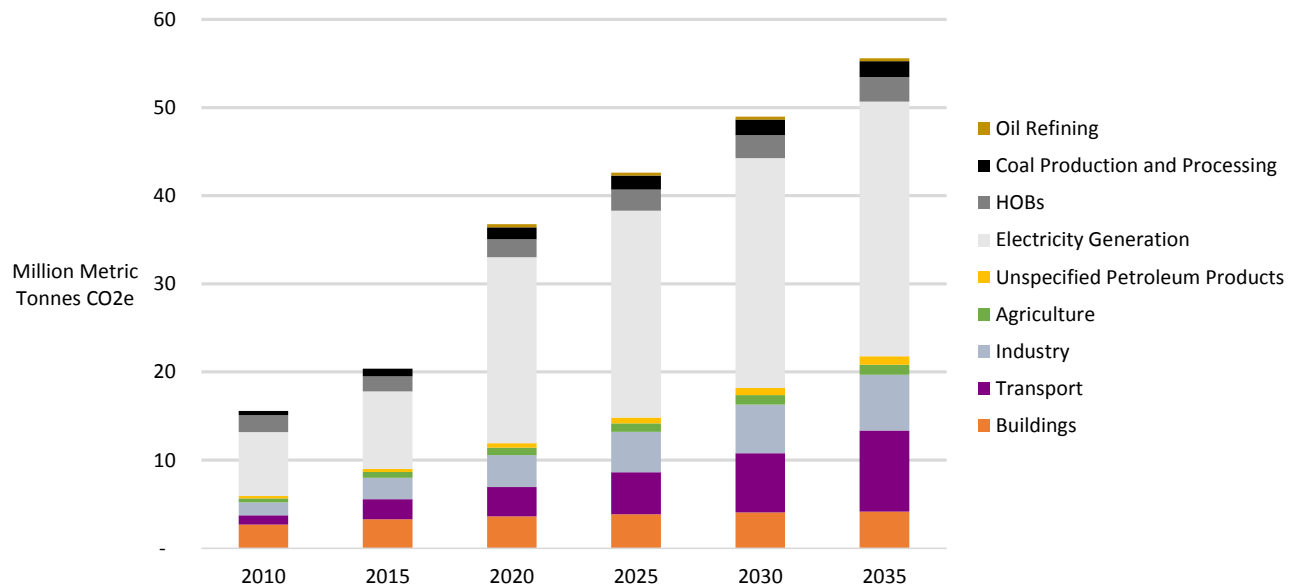

Figure 10-8. GHG emissions by fuel, *reference scenario*

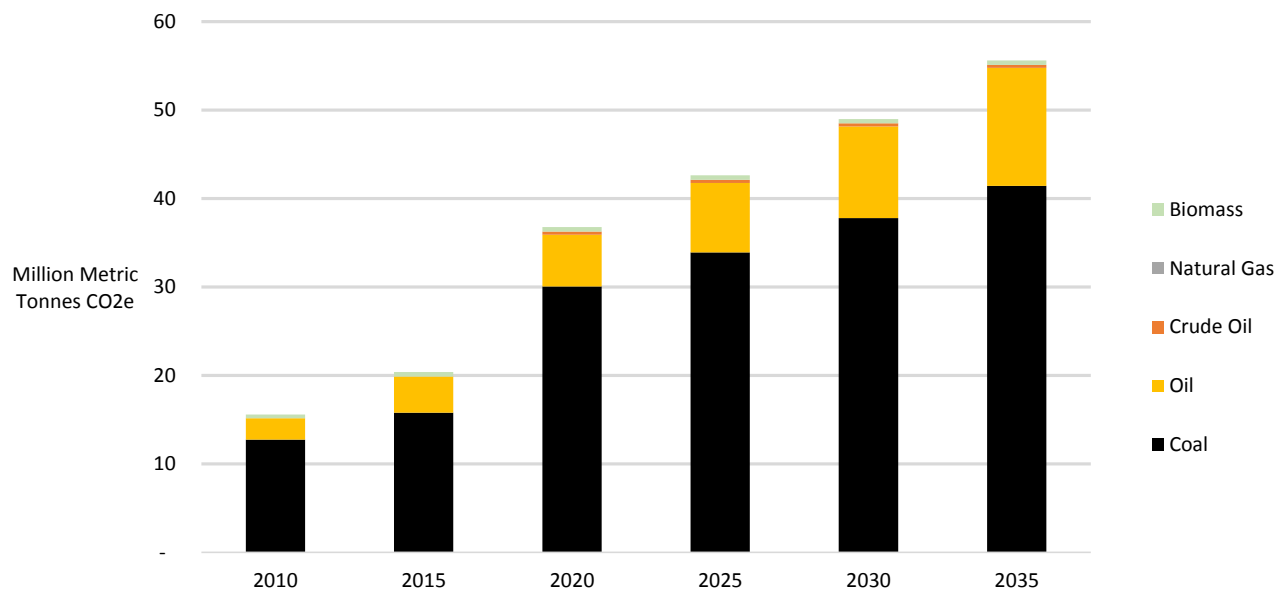

Figure 10-9. GHG emissions by sector, *recent plans* scenario

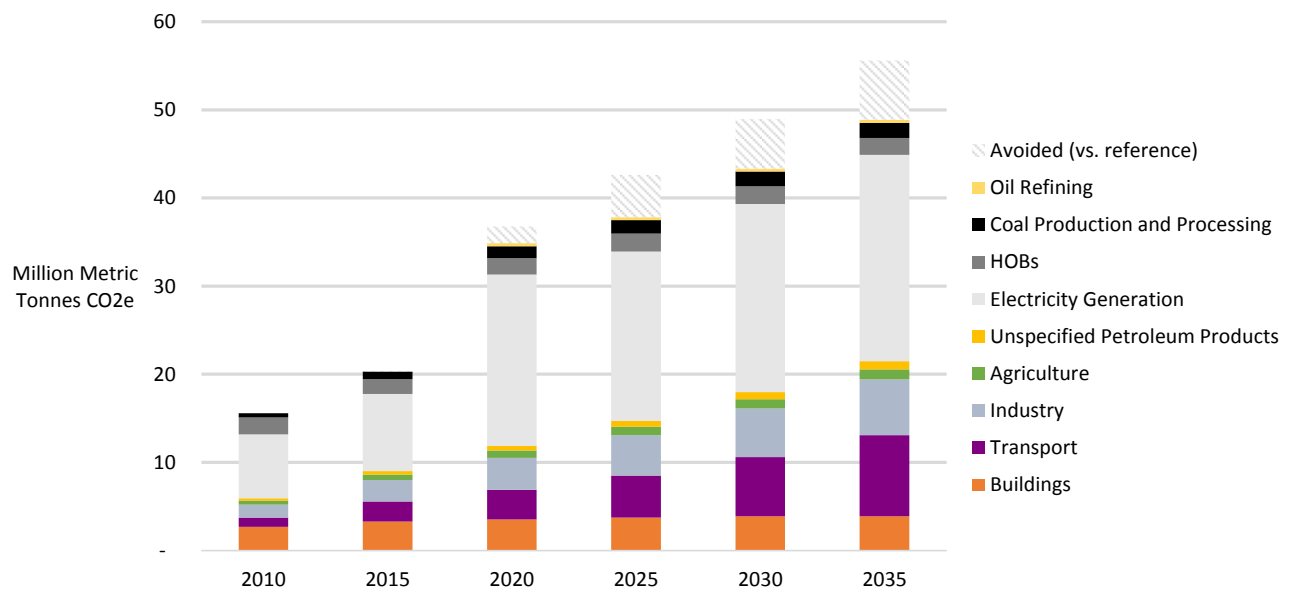

Figure 10-10. GHG emissions by fuel, *recent plans* scenario

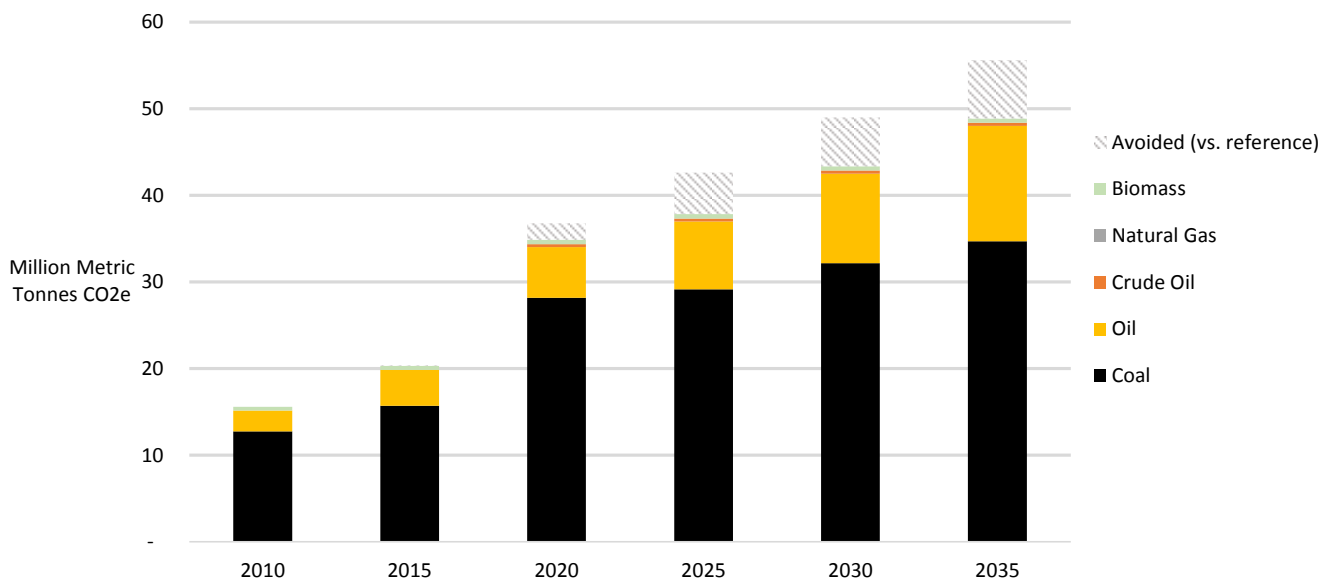

Figure 10-11. GHG emissions by sector, *expanded green energy scenario*

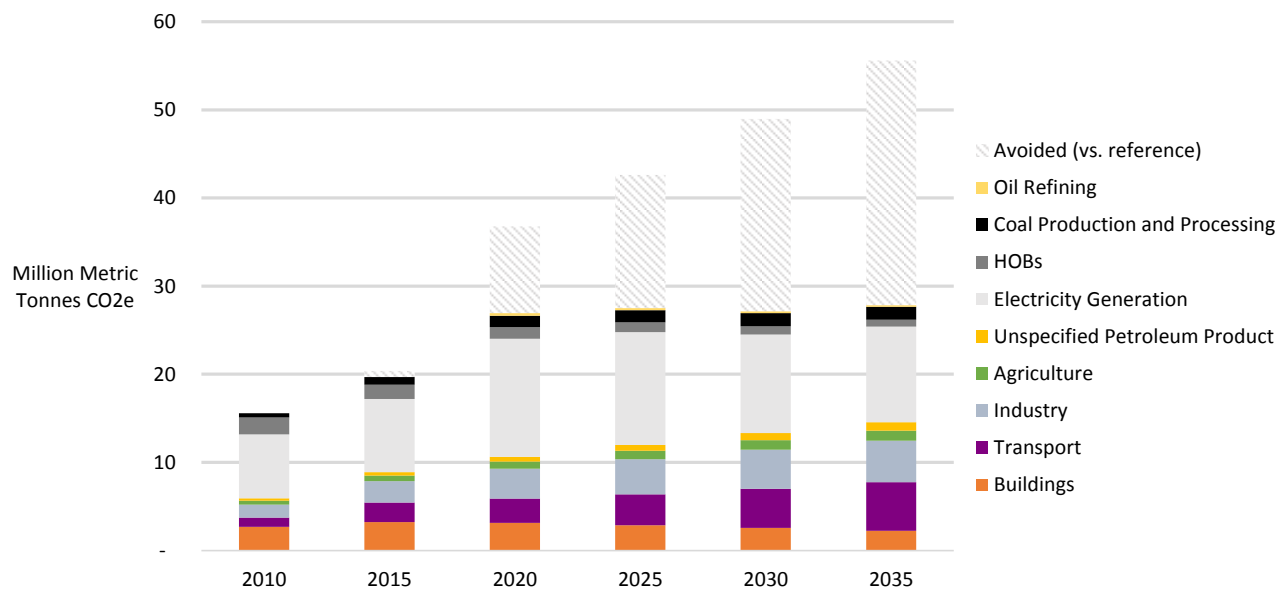
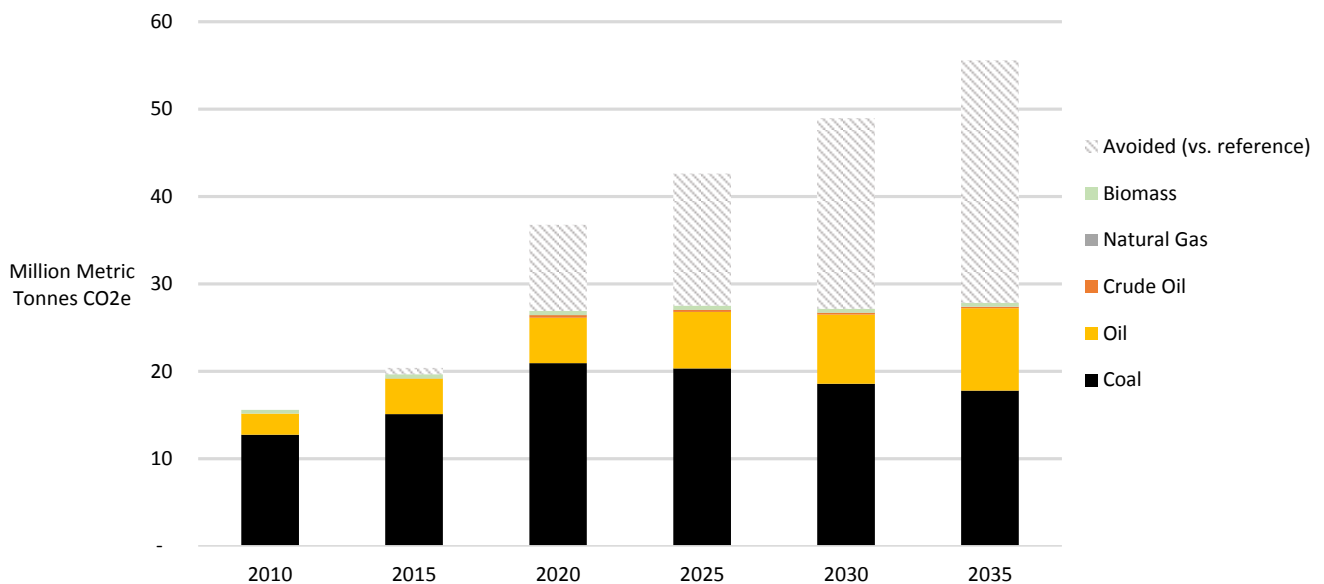

Figure 10-12. GHG emissions by fuel, *expanded green energy scenario*



As discussed in Chapter 2, another way to account for GHG emissions is to count the eventual CO₂ emissions that result from a fossil fuel extracted in a country, such as coal in Mongolia, regardless of where it is combusted. To explore the implications of this study's results on Mongolia's extraction-based emissions, Figure 10-13 compares the extraction-based emissions for the reference and shift in

energy exports scenarios. Here, year 2035 extraction-based emissions in the reference case are nearly four times higher than the territorial emissions calculated as in Figure 10-7 and Figure 10-8, suggesting that Mongolia's contribution to global greenhouse gas emissions, viewed from the perspective of fuel extraction, is significantly greater than its in-country emissions may suggest. The shift in energy exports scenario reduces Mongolia's extraction-based emissions to less than 20 MTCO₂e by 2035, equivalent to the in-country emissions from burning coal (as in the expanded green energy scenario), and yielding a reduction in extraction-based GHG emissions of 180 MtCO₂. Whether global GHG emissions would ultimately be reduced by a similar amount would depend on whether the consumers of these fuels (e.g., power or steel plants in China) ultimately substituted for coal imported from Mongolia with other sources of coal. At the same time, CO₂ benefits could also result if the electricity exported by Mongolia under the shift in energy exports scenario were to displace additional coal-fired power generation outside Mongolia (other than that which would have used Mongolian coal), though those possible benefits have not been quantified here. Regardless, this analysis indicates Mongolia's most significant contribution to global greenhouse gas emissions may be in the coal it may export, and that shifting from exporting coal to exporting renewable electricity could perhaps be its most significant contribution to a low-carbon, green economy.

Assessing GHG emissions from an extraction-based perspective can also help assess alternative development for "low-carbon competitiveness" (Vivid Economics 2009) and carbon "entanglement" (Gurría 2013), as described earlier in this report and explored further in Appendix B. For example, should China or other coal consumers place limits or taxes on CO₂ emissions or coal consumption (as China is already planning to do), demand for Mongolia's coal could decline. Counting the emissions associated with coal from such an extraction-based perspective is one step towards quantifying this risk.

Figure 10-13. Extraction-based emissions under the *shift in energy exports* scenario, relative to the *reference scenario*

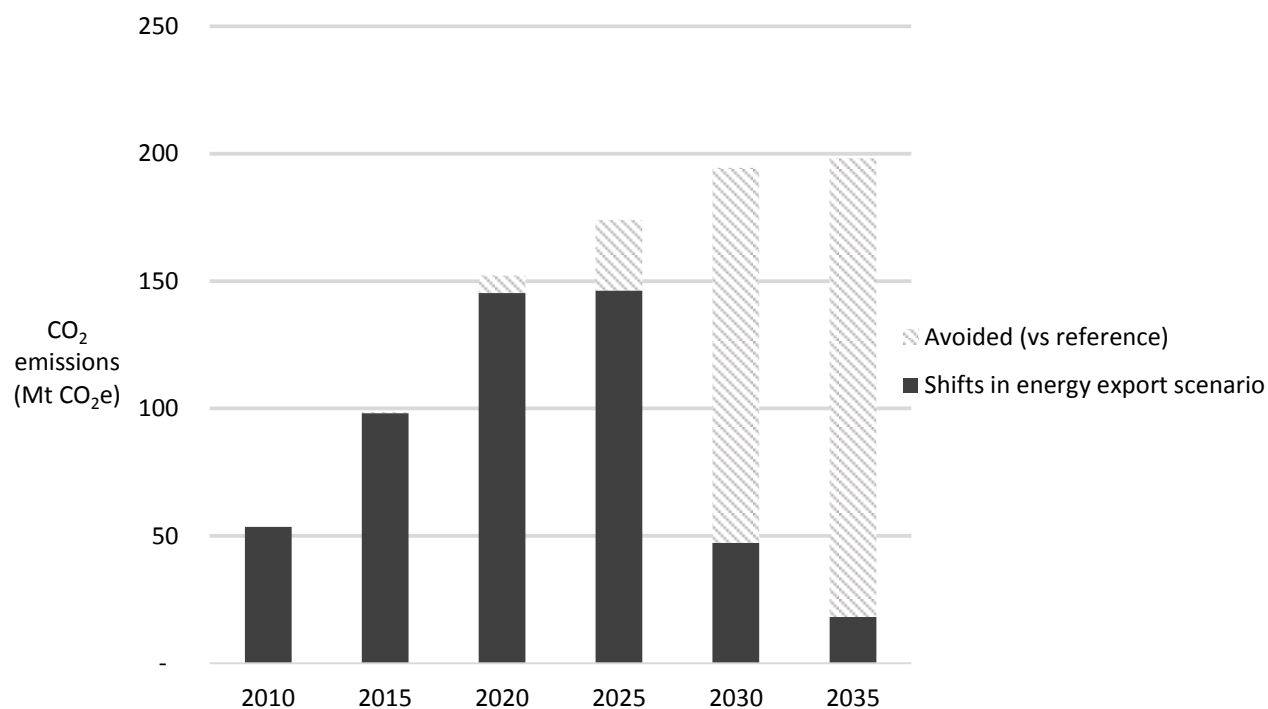

10.4 Other pollutant emissions

One of the most important problems facing policymakers in Mongolia, particularly those in the Ministries of Energy and of Environment and Green Development, is local air pollution, particularly air pollution in Mongolia’s cities during the heating season. Reducing episodes of heating season “smoke” (a combination of particulate matter, sulfur oxides and nitrogen oxides) from coal-fired combined heat and power plants, but also from coal-fired district heating plants and on-site boilers and, crucially, fuels—including coal, biomass, and wastes such as used tires--burned to provide heat in urban and per-urban households, is a key concern. Emissions of, and impacts of, air pollutants such as these is an especially local concern that is best treated with localized assessments and models that take into account specific locations and control technologies rather than national analyses such as that conducted here. At the same time, we can use results of this study to estimate directional impacts on key air pollutants, such as for sulfur oxide and nitrogen oxide (SO_x and NO_x) emissions nationwide. Figure 10-14 and Figure 10-15 show the estimated sulfur oxides (as SO₂) and nitrogen oxides emissions over time in the reference, recent plans, and green energy scenarios.

Figure 10-14. Sulfur Oxide Emissions under Three Scenarios

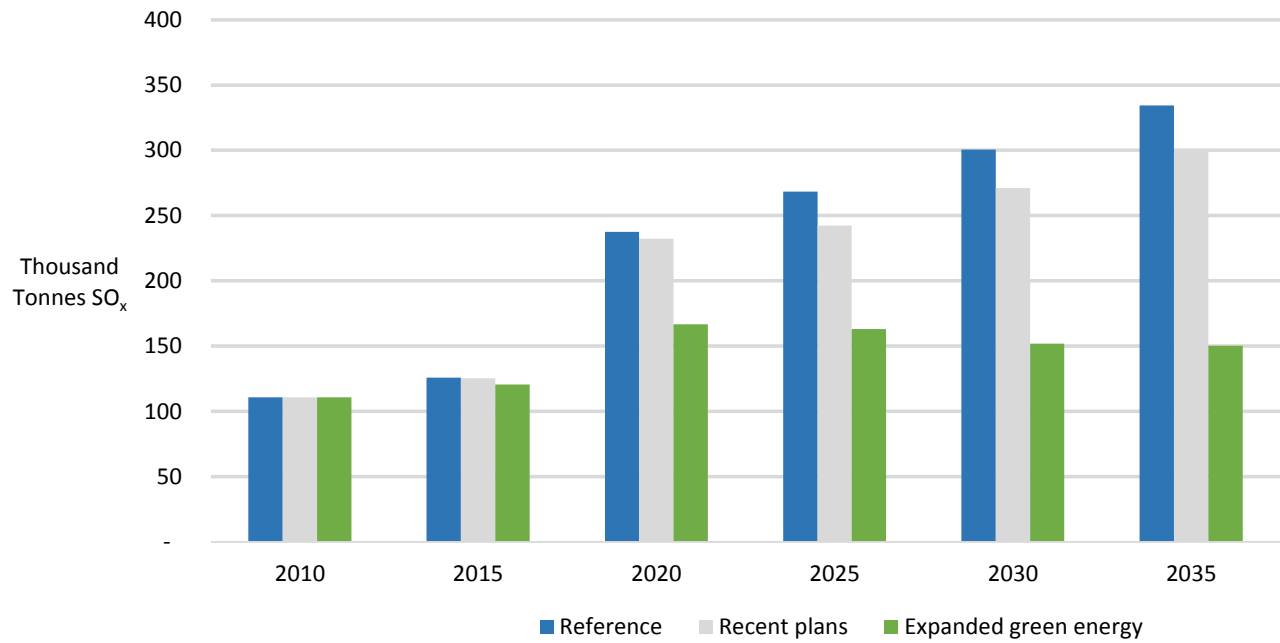
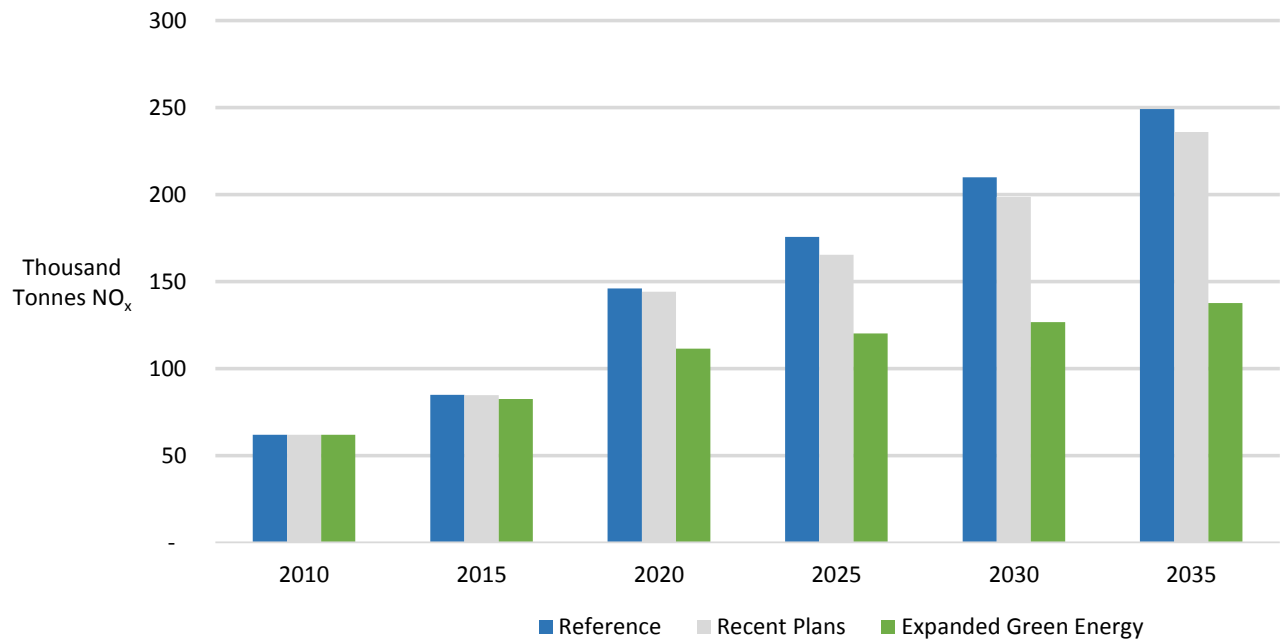

Figure 10-15. Nitrogen Oxide Emissions under Three Scenarios



The recent plans case offers modest reductions in both types of emissions, while the expanded green energy scenario reduces emissions of both by over 50 percent in 2035, relative to the reference case. Although particulate matter (smoke) emissions cannot be directly estimated here³², these emissions would be reduced at least proportionately with NO_x and SO_x emissions by the green energy scenario, and possibly more, depending on how, for example, the specific modifications to coal-fired power plants and HOB are implemented, and to the emissions characteristics of ger heating stoves displaced or upgraded.

It should be emphasized that although the inventory of current and estimate of future emissions of local and regional air pollutants such as SO_x, NO_x, and particulate matter are a first step in developing plans for mitigation of the impacts of those emissions, it is only a first step. The estimation of human health and other environmental impacts (other than climate change) associated with these emissions requires, sequentially, the geographic specification of emission source locations, the modeling of atmospheric transport, ambient concentrations, and deposition of pollutants, and the assessment of impacts on humans, animals, and plants. These steps are beyond the scope of the current project, but could be the focus of future modeling work, as suggested in the presentation of potential follow-on activities described in Chapter 9 of this Report.

10.5 Cost-effectiveness analysis

Transitioning Mongolia to a low-carbon economy brings a number of costs and benefits. Estimating all costs and benefits all would be an enormous undertaking, depend on a number of unknown factors (such as rate of reduction in costs in key efficiency and renewable energy technologies), and be subject to large uncertainties. At the same time, estimating the cost effectiveness of options at meeting key goals – such as greenhouse gas reduction – can help planners understand differences in costs, and where measures that save costs (e.g. energy efficiency) may be able to help offset costs of other, higher cost measures that are desirable because they bring extra benefits they may bring, or because they too are needed to meet goals on renewable energy deployment or GHG emission reduction. This section estimates the cost-effectiveness of the measures assessed in this study according to the cost per ton of GHGs avoided or reduced, as is common in scenario analyses of low-emissions development strategies (Winkler 2007; Halsnaen et al. 1999; Johnson et al. 2010). This method assesses the incremental capital and operating and maintenance costs of key technologies (such as renewable electricity or energy efficiency retrofits) as well as the savings from avoided fuel usage. It does not include taxes or subsidies, financing costs (e.g., interest), or administrative costs.

³² Preparing estimates of particulate emissions require Mongolia-specific emission factors for major sources of these pollutants, both on the energy demand (for example, ger stoves burning biomass and waste fuels) and energy supply (power and heat) sides. Although a comprehensive set of particulate emission factors was not available for this project, it could be developed and applied to the LEAP model described here;

All costs after 2010 are discounted using a 5 percent real annual discount rate. Costs are included for all measures except those related to reduction in vehicle travel (through urban planning) or shifting from one transport mode (typically car, truck, or airplane) to another (typically bus or train), due to the complexity in estimating costs of building new transport infrastructure and avoiding others (e.g. specific vehicles.)³³ Estimating future costs of technologies and fuels is difficult over even a fairly short time frame, as costs will vary based on global energy markets, economic growth in Mongolia and elsewhere, and technology learning. Accordingly, all estimates of these costs are subject to significant uncertainty.

Figure 10-16 presents a greenhouse gas abatement “cost curve” of results for all of the measures, comparing overall estimated annualized costs (that is, with capital costs amortized for presentation on an annual basis) with emissions savings that could be realized in the year 2035 relative to the reference scenario. Cost curves have become common tools in GHG abatement analyses (as they have been in energy savings assessments for decades previously) to help assess how savings might be achievable for how much cost.

Many of the measures and options show negative costs of reduced GHG emissions, meaning that the overall direct benefits of the options exceed the costs. For example, though upgrading industrial boilers has a cost, it can lead to considerable savings in energy (coal) costs over time. As indicated in Figure 10-16, about half of the 28 MtCO₂e GHG abatement potential in this study is available at negative costs, suggesting significant potential savings to Mongolia’s economy for energy efficiency.

³³ As a result, these options are included in the cost curve at zero cost.

Figure 10-16. “Cost Curve” showing GHG savings and cost per tonne of CO₂e reduced in 2035

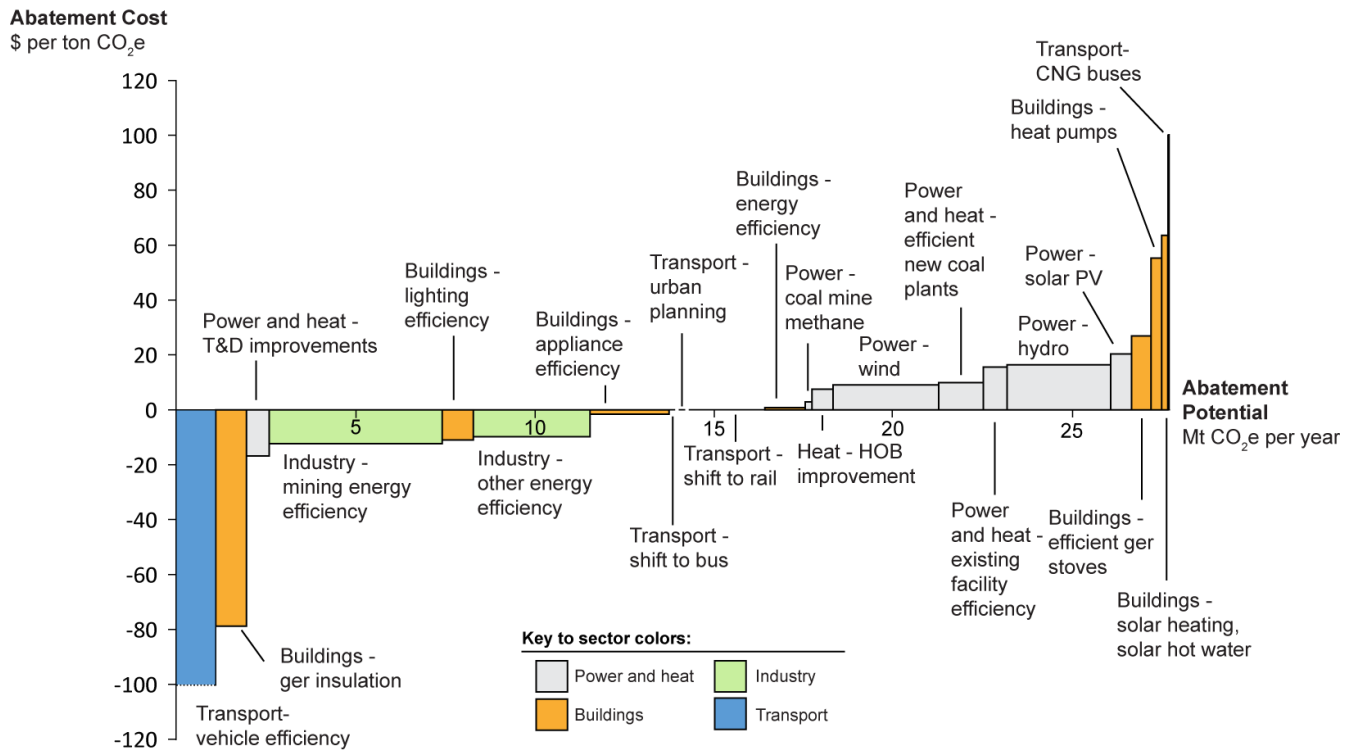

The estimation of costs also enables an estimate of the incremental costs associated with entire scenarios (compared to the reference case), including the types of capital and operations and maintenance costs discussed above. The total net present value (NPV) of the expanded green energy scenario compared to the reference scenario through 2035 is a benefit of USD 380 million. This is comprised of significant investments in demand-side efficiency (roughly 2.5 billion USD) such as for building envelope improvements, relatively modest net incremental investments in electric generation (170 million USD) such as the extra costs of hydroelectric power plants compared to coal-fired power plants, and significant fuel savings (roughly 3 billion USD), as specified in Table 10-3. Over half of the fuel savings is from avoided oil consumption as a result of more efficient vehicles, a finding that is driven in part by the high cost (per equivalent unit of energy) of gasoline and diesel relative to coal in Mongolia.

Table 10-3. Estimated cumulative incremental costs (net present value) of *expanded green energy scenario* versus reference scenario, assuming 5% real discount rate³⁴

	Incremental cost (million USD)
Demand-side efficiency investments	2,490
Power and heat generation	170
Fuel savings	(3,040)
Total NPV	(380)

Lastly, though this study does not include an assessment of financing opportunities, Mongolia has several financing options, from a variety of sources. Financial support for the initiatives identified and described through the process noted above could come from a variety of sources, from private financing within and outside of Mongolia, international organizations (GGGI, UNDP, the World Bank, and others), the Mongolian government (including earmarked revenues from mining or other industries), bilateral aid donors, UNFCCC mechanisms for climate finance (e.g., the Green Climate Fund), and others.

11 Conclusions and Next Steps

11.1 Summary of overall findings

This study outlines four scenarios of how Mongolia's energy systems could evolve over the next two to three decades. The *reference* scenario foresees Mongolia's continued reliance on coal-based power and heat supply, in an economy based largely on copper and coal exports. In this scenario, primary energy demand in Mongolia is more than three times higher in 2035 than it is today. The *recent plans* scenario builds on the *reference scenario* and assumes implementation of current priorities of Mongolia's Ministry of Energy and Ministry of Environment and Green Development: namely, deployment of specific hydropower and wind power plants, increased efficiency at existing coal-fired power plants, and programs to promote insulation of panel apartment buildings in Ulaanbaatar and more efficient lighting throughout the country. The *expanded green energy* scenario sees all sectors of Mongolia pursue extensive energy efficiency measures, realize all currently-proposed renewable energy projects, and begin to transition away from the dominance of coal power as older power plants are retired. Realizing this scenario would also require a host of associated advancements to Mongolia's energy system, such as improved transmission and distribution infrastructure. Lastly, the *shifts in energy export scenario* transforms how Mongolia contributes to regional energy markets. In this scenario, Mongolia shifts away from exporting coal to instead export

³⁴ Cost assessment does not include costs and benefits of mode shift to bus or rail, or for urban planning to reduce overall vehicle demand.

renewable electricity, with potential economic benefits for the country (“green growth”), and global benefits for greenhouse gas emissions and climate. This transformative scenario, which would require significant international partnerships and financing, is motivated (in part) by the possibility that global coal demand could decline if the world’s major economies implement policies to confront climate change and limit warming to two degrees C over pre-industrial levels.

The results of the *expanded green energy* scenario suggests that energy efficiency initiatives can slow the growth in Mongolia’s energy demand by 10% below reference levels in 2020 and by more than 30% below reference levels in 2035.. Along with increasing penetration of renewable electricity (and heat), the measures included in the expanded green energy scenario could halve GHG emissions by 2035, from 56 million tonnes CO₂e in the reference case to 28 million tonnes CO₂e. Mongolia also has the potential to contribute even more strongly to global climate change mitigation by exporting renewable electricity and phasing down exports of coal, the fuel that is most carbon-intensive and contributes most to global climate change. Doing so could also provide economic benefits to Mongolia, including reduced exposure to climate and other policies that reduce global, in addition to Chinese, coal demand and make Mongolia a shining example of “green growth”.

At the same time, neither these scenarios nor this report should be read as an endorsement of any particular energy or emissions pathway. While this analysis shows what might be possible with assertive efforts by Mongolia’s government and most other economic actors in the country, other pathways are also possible, and may bring similar social, economic, and political benefits. Furthermore, none of the scenarios (even the reference scenario) should be interpreted as a definitive forecast. Mongolia’s economy is developing rapidly, and the mining, construction, and other sectors, and their associated energy use, could evolve much differently than assumed here.

Any ambitious effort to greatly expand renewable energy and energy efficiency in Mongolia will require political leadership and partnerships with the international community, as well as concerted effort to address a host of factors, from financial to technical to administrative, that have limited uptake of renewable energy and energy efficiency to date. To those ends, below we discuss some potential policy initiatives that Mongolia could pursue, as well as an initial list of possible projects and research efforts that could begin the transition to a low-carbon economy in Mongolia, and that could attract international support.

Indeed, international financial support will likely be critical, especially given Mongolia’s relatively modest level of development. For example, the “Green Climate Fund” of the United Nations Framework Convention on Climate Change is intended to provide funds totaling \$100 billion per year by 2020 to support GHG emission reductions in developing countries. Discussions on longer-term financing under the UNFCCC have also begun to draw distinctions between the deep level of emissions reductions needed in developing countries and the parties (e.g., developed countries) that

may finance those reductions (Metz 2013; Ngwadla 2013). This suggests that efforts to pursue deep GHG emissions in Mongolia may benefit from significant support in the long-term.

11.2 Policies for consideration

The preceding sections have discussed possible policy initiatives to scale up energy efficiency and renewable energy in each major sector: power and heat, buildings, industry, and agriculture. Though a comprehensive assessment of each was beyond the scope of this report, we summarize the possible policy initiatives here to help prompt further discussion. Each of these initiatives is associated with measures (as in the cost curve in Chapter 8) that could reduce Mongolia's GHG emissions by at least one million tonnes in 2035, as well as deliver local air pollution benefits, relative to the reference case:

- Strengthening the 2007 Renewable Energy Law, and developing a new Renewable Energy Program, based on analysis such as that presented in this report
- Reforming subsidies on coal, electricity, and district heat to minimize support, via tariffs or otherwise, for inefficient consumption and high-carbon energy sources
- Developing and enforcing more stringent building energy codes and appliance efficiency standards
- Expanding building retrofit programs from the existing programs focused on energy retrofits of existing apartment buildings
- Developing guidelines for urban planning and transportation planning, including combined land use and transportation planning, as well as a national strategy for moving people and goods more effectively and efficiently
- Developing energy and/or emissions standards for widely used industrial- technologies (e.g. those in the mining sector) or for primary industry sectors that make particularly energy-intensive materials
- Enhancing vehicle efficiency or emissions standards

In addition, the Ministry of Environment and Green Development may wish to use this analysis to help inform or explore national goals on GHG emission reduction. For example, this analysis could help inform national targets on GHG emission reduction or sustainable development, and strategies to attain them. Furthermore, in addition to goals on territorial GHG-intensity (per unit of GDP) that MEGD has considered, developing a supplemental goal based on extraction-based GHG-intensity may help Mongolia more comprehensively track progress towards a green economy and away from “carbon entanglement”.

Each of these policy initiatives could likely also benefit from further research, pilot programs, and program development, which are discussed in the next section.

11.3 Potential “next steps” for green energy development: projects, pilots, and further research

Below we discuss opportunities for ongoing energy planning projects, pilots, or research that Mongolia, could undertake, building upon the results of this project. These efforts could include:

- Periodic revision/updating of energy plans using the tools and training provided during the project;
- Regular data collection and updating of the LEAP model for Mongolia;
- Additional surveys to collect more accurate data for planning;
- Periodic use of the tools provided by the project to update emissions inventories for Mongolia;
- Developing capacities for local air pollution impact modeling, potentially using the LEAP model as one source of emissions data; and
- Other potential initiatives, together with the organizational structures and training needed to support them.

Some of these areas for future work are elaborated below.

Data gathering

By the standards of many countries, data availability for energy and environmental analysis in Mongolia is quite good. There remain, however, a number of areas where the implementation of periodic surveys would benefit future planning efforts, and make the analysis of energy and environmental policy options more straightforward and accurate. These areas include:

- Household energy end-use surveys, for all fuels, in each major type of housing and major residential area in Mongolia. Such surveys, based, for example, on survey instruments developed by the World Bank or in use in the United States (the “RECS” Residential Energy Consumption Survey, which is undertaken every few years by the US Department of Energy), would provide estimates of device ownership by household type, and fuel/energy use by devices in households.
- Commercial building sector surveys allowing the division of the commercial and institutional sector by type of building and/or by type of activity (for example, hotel, restaurant, office, hospital/health care, and education). Such surveys would indicate the fraction of total

building floorspace or volume in each subsector, and a series of such surveys would chart changes in the commercial/institutional sector over time.

- Commercial energy end-use surveys, for all fuels, divided each major type of building and/or activity (as above). Such surveys, of which the United States “CBECS” Commercial Building Energy Consumption Survey is an example, provide estimates of energy use per unit building space or volume by building type and by fuel.
- Industrial energy surveys and audits, which would provide estimates of energy intensity, overall energy use, and available energy savings in the industrial sectors. To some extent these surveys may be accomplished through review (with confirmation/correction where necessary) of Ministry of Industry data, at least for major facilities, as private industries, including mining, become more important for the Mongolian economy. Monitoring and reporting efforts, such as those being developed and implemented at national levels through international partnerships such as the Partnership for Market Readiness, could be of particular relevance.
- Surveys in the agriculture sector, on energy use and livestock production practices.
- Ongoing testing of the efficiency and emissions performance of appliances used in Mongolia, and especially devices, including cooking and heating stoves, that may be unique to Mongolia and central Asia. This would include testing not only of emissions of GHGs from these devices, but of other air pollutants

The data collection activities above should ideally be established within a comprehensive, regular (for example, every three years), reviewed, and internally cross-checked system of collection of information for energy, transport, and climate change action planning. This would include regularizing extensive and methodologically-sound surveys of energy use in each of the sectors of Mongolia’s economy, with surveys on the national level backed up by as appropriate by surveys at the municipal and provincial levels.

Capacity building

Strengthening of capacity for energy and climate mitigation planning at the National, and, as needed, provincial and municipal levels could be encouraged through a program of training and tools development, ideally with customizable but common tools used throughout the country. In addition, to ensure that skills in using such tools are maintained, a regular process of GHG inventory preparation and mitigation action planning could be instituted, possibly, for example, in conjunction and cooperation with the preparation of national and regional Master Plans and Power Development Plans, and the evolving requirements for biennial update reports to National Communications under

the UNFCCC. The tool used for the analysis presented in this report, LEAP, could remain part of the capacity building, as it was for the Mongolian government officials involved in this project.

Pilot programs

Pilot programs could help demonstrate technologies or practices for eventual widespread adoption. These may include

- Mongolian government buildings could launch “lead by example programs” where they were to implement highly efficient building and lighting energy retrofits, to demonstrate the efficacy of these approaches.
- Demonstration projects **on reduction of electricity use in industry** through increasing the use in existing facilities, and insisting on the purchase for new facilities, of high-efficiency electric motors, variable speed motor controls, and electric motor-related technological improvements, for example, in pumping, air compressors, materials handling, and process equipment, other end-uses. Many of these measures apply to agricultural electricity use (irrigation, crop processing, ice-making) as well. A program to do so could include restrictions on imports of motors that do not meet efficiency standards, industrial audits, particularly in large enterprises, to identify savings opportunities, the development of funding mechanisms for paying the initial capital costs of implementing efficiency options, and the provision of technical information on options to consumers large and small.
- Continued pilots and demonstrations of ground source heat pumps, one of the few technologies available in Mongolia that has the capacity to create, in the long-term, very low carbon heating.
- Pilot demonstrations of revised tariffs for district heat, for example, in specific sectors or service areas, coupled with implementation of metering and control systems for use by heat consumers.
- Continued pilots on institutional and governance models for energy efficiency and renewable energy, including on modes of engagement for energy providers and technology suppliers, finance options, and public-private partnerships.

Research

Additional research would be helpful on a number of topics, including (but not limited to) the following.

- **Review of heat and power options incorporating renewable electricity generation.** As noted above, the territory of Mongolia includes rich solar and wind energy resources that could be

tapped to yield clean energy for Mongolia and for exports. These resources, however, are by their nature intermittent, meaning that either other, likely fossil-fueled resources, electricity storage on a large scale, or a combination of the two would need to be employed for renewable power generation to operate effectively in Mongolia's energy system. Further research is needed to understand how to address intermittency through storage and balancing services, including the role of hydro and pumped storage hydro, in meeting peak loads. Further research is also needed to recommend pricing reforms that can allow for on-peak and off-peak power to be, at least for most consumers, priced at a level to allow full cost recovery.

Another key question is how to provide heat for residential and other buildings using renewable energy. One advanced option is to use ground-source heat pumps to turn electricity into heat at very high efficiencies.³⁵ It may also be possible generate and then store heat for hours, days, or even between seasons. Heat would then be released to the district heating system (or to an individual home or building) when needed. Lastly, a simple (though less efficient) option may be inexpensive resistance heaters in homes and businesses, or adding resistance coils to district heating systems so that those systems can use renewable electricity when it is available as surplus.

A potential follow-on initiative to the current project is therefore to explore future scenarios for the integration of renewable electricity systems with urban or rural heating. For urban systems, this would require advanced modeling of heat needs in urban areas, including of the timing and extent of heat requirements by different types of consumers, and by different central heating systems (for example, those currently supplied by CHP or by heat-only boilers). This process would build upon some of the work undertaken during the recent effort to update the Energy Sector Master Plan, undertaking with funding from the Asian Development Bank (ADB). It would also require a review of the cost and performance of existing and potential technologies for electric space heating, and for electricity and/or heat storage. Development of a pilot project is a longer-term possibility.

On a smaller scale, a similar follow-on initiative might be to explore the use of renewable heating and heat storage systems for deployment in soum centers and villages, again, possibly, with a pilot project to demonstrate key technologies. (To date, solar hot water systems have been limited by a number of factors, including pollution causing grime on surfaces of collectors, cold temperatures, and limited cost-effectiveness.)

³⁵ Resistance heaters convert electricity into heat with an efficiency of essentially 100 per cent. Heat pumps use electric motors and pumps to compress and expand a "working fluid" to move heat from the ambient air or water or, in the case of ground-source (or "geothermal" heat pumps, from the earth, resulting in an overall efficiency that can be well over 100 percent. Depending on the conditions, ground-source heat pumps can produce heat from electricity at an efficiency of 300 percent (or a "coefficient of performance" ratio of heat out to electricity in, of 3.0) or more.

- **Review of heat and power options for Ulaanbaatar with consideration of impacts on local air pollution.** A special case of the exploration of heat and power options above would be to focus on the unique situation in Ulaan Baatar (UB), and to develop a demand- and supply-side model focusing on the provision of heat and power to the residents and businesses in the city, with a special emphasis on exploring alternatives for reducing air pollution. Such a project would bring together considerations of urban planning (for example, evolving housing and transport systems to promote the use of cleaner energy source for heating) with engineering of heat and power systems, and with the modeling of emissions and atmospheric transport of air pollutants such as particulate matter, sulfur oxides, and nitrogen oxides. Note, however, that detailed air pollution modeling is a technically-demanding and data intensive process, thus it may be prudent to approach the project in phases, for example, starting with an inventory of local air pollutant emissions (adding detail and location-specific data to the LEAP model developed for this project), including perhaps installation of stationary emissions monitoring devices, then exploring detailed future scenarios for UB while at the same time developing or expanding capabilities for atmospheric modeling of air pollution in the UB “airshed”.
- **Continued research on residential and commercial energy efficiency financing and implementation structures,** in partnership with the existing local and international institutions working on this topic, including information on building owner and tenant attitudes, barriers, and decision-making processes regarding energy efficiency upgrades.
- **Research on possible legal and market instruments for reducing GHG emissions in Mongolia.** Other countries, including developing countries, have been exploring and implementing various forms of emissions limits, trading, and pricing systems, including coal caps and emissions trading systems (ETS) in China and intensity-based trading in industrial sectors in India. Research could explore possible application of similar mechanisms in Mongolia.
- **Advanced exploration of green energy exports scenarios.** As noted above, to bring to fruition a future in which Mongolia, whether through government-owned plants or from plants owned and operated by the private sector—exports power generated from renewable energy to China, and perhaps to Korea and/or Japan, will require intensive work on a number of issues, ranging from the technical to the economic to the political. An initiative to follow on the initial work on the green energy export scenario explored during the current project could include more fully evaluating the costs and potential economic benefits to Mongolia as a whole, and to various actors in Mongolia, of different scenarios for exporting electricity generated from Mongolia’s solar and wind resources, necessarily combined with a review of the technical requirements for such exports. In parallel, explorations, probably as a part of an existing or new regional international group, would need to be carried out to further develop some of the

international technical and financial options for (and challenges involved in) selling power to countries in the region, including developing infrastructure for exporting across borders, pricing for renewable electricity, technical and environmental standards for transmission lines, and other issues, perhaps drawing on experiences from other international power sharing arrangements, whether in Asia (e.g., Southern Mekong) or from other continents (e.g., UCTE in Western and Central Europe, NORD-POOL in Scandinavia) . Coordination with existing multi-national programs and/or institutions in which Mongolian government agencies are involved, such as the Greater Tumen Initiative organized by UNDP, will likely be desirable.

- **Exploration of the effect of exports of Mongolian coal to regional markets.** This study has introduced the concept of extraction-based emissions accounting to describe the emissions associated with fossil fuel extracted in Mongolia, much of which is exported. Further research could explore the effect of shifting exports away from coal on broader fossil fuel markets in the region (especially in China), and the extent to which such a shift may contribute to global GHG emission reductions on one hand, or emissions leakage (e.g., if coal consumers in China find other sources) on the other hand.

12 References Cited

- ADB, 2008. *Energy Conservation and Emissions Reduction from Poor Household*.
- Alvarez, R. A., Pacala, S. W., Winebrake, J. J., Chameides, W. L. and Hamburg, S. P., 2012. 'Greater focus needed on methane leakage from natural gas infrastructure'. *Proceedings of the National Academy of Sciences*, 109(17). 6435–40. doi:10.1073/pnas.1202407109.
- Arc Finance, 2012. 'Xacbank's Eco-Banking Department: Improving Air Quality with Credit, Carbon Finance and Smart Subsidies'.
- Baatar, B., 2012. 'Country Presentation: Mongolia'. Presented at the Training and Dialogue Programs of JICA: Energy Policy (B). Institute of Energy Economics, Japan.
<http://eneken.ieej.or.jp/data/4480.pdf>.
- Barma, N., Kaiser, K., Le, T. M. and Viñuela, L., 2011. *Rents to Riches? The Political Economy of Natural Resource-Led Development*. The World Bank, Washington, DC.
- BGR, 2013. *Energy Study 2012: Reserves, Resources and Availability of Energy Resources*. The Federal Institute for Geosciences and Natural Resources (BGR) on behalf of the German Mineral Resources Agency (DERA)., Hannover, Germany.
http://www.bgr.bund.de/DE/Gemeinsames/Produkte/Downloads/DERA_Rohstoffinformationen/rohstoffinformationen-15e.pdf;jsessionid=AAA371EC060D47D474F1F529163D4CAE.1_cid334?__blob=publicationFile&v=3.
- Carbon Tracker Initiative, 2011. *Unburnable Carbon – Are the World's Financial Markets Carrying a Carbon Bubble?* London. <http://www.carbontracker.org/carbonbubble>.
- Chen, W., Li, H. and Wu, Z., 2010. 'Western China energy development and west to east energy transfer: Application of the Western China Sustainable Energy Development Model'. *Energy Policy*, 38(11). 7106–20. doi:10.1016/j.enpol.2010.07.029.
- Davis, S. J., Peters, G. P. and Caldeira, K., 2011. 'The supply chain of CO2 emissions'. *Proceedings of the National Academy of Sciences*, 108(45). 18554 –18559. doi:10.1073/pnas.1107409108.
- Dorjpurev, J., 2013. *GHG Mitigation Scenarios in Energy Sector (Summary)*. EEC Co. for the Mongolia Ministry of Environment and Green Development, Ulaanbaatar, Mongolia.
- ECA, 2008. *Renewable Energy Regulatory Analysis Report*. Mongolia: Renewable Energy Regulatory Development Road Map. Economic Consulting Associates Limited, London, UK.
- egen and MonEnergy Consult, 2013. *Updating Energy Sector Development Plan: Draft Executive Summary*. Prepared for The Asian Development Bank and The Mongolian Ministry of Energy.

- Elliott, D., Schwartz, M., Scott, G., Haymes, S., Heimiller, D. and George, R., 2001. *Wind Energy Resource Atlas of Mongolia*. NREL/TP-500-28972. National Renewable Energy Lab., Golden, CO (US). http://www.osti.gov/energycitations/product.biblio.jsp?osti_id=787886.
- Enkhbayar, S., 2013. *Special Feature: Latest Developments in the Mongolian Economy*. ERINA Report, 109. Economic Research Institute for Northeast Asia.
- Ernedal, S., 2013. 'Utilizing the energy and cost saving potential in the Mongolian energy sector through a legal framework for energy efficiency as well as performance optimization and preventive maintenance in energy utilities'.
- Eurasia Capital, 2011. *Mongolia Outlook 2010-2020*. Hong Kong. <http://www.eurasiac.com>.
- Fisher, B. S., Batdelger, T., Gurney, A., Galindev, R., Begg, M., Buyantsogt, B., Lkhanaajav, E. and Chadraaval, B., 2011. *The Development of the Oyu Tolgoi Copper Mine: An Assessment of the Macroeconomic Consequences for Mongolia*. BAEconomics for Rio Tinto, Canberra.
- Fraunhofer IBP, 2008. *Scientific Monitoring of Building Restorations in Ulan Bator and Assessment of the Energy Savings Potential as Well as Derivation of General Measures for Quality Assurance*.
- GGGI, 2013. *Strategies for Green Public Transport in Mongolia*. Global Green Growth Institute.
- GGGI, 2011. *Green Growth in Motion: Sharing Korea's Experience*. Global Green Growth Institute, Seoul.
- GGKP, 2013. *Moving towards a Common Approach on Green Growth Indicators*. Green Growth Knowledge Platform Scoping Paper. GGKP including staff from the Global Green Growth Institute, Organisation for Economic Co-operation and Development, United Nations Environment Programme, and World Bank, Paris. http://issuu.com/ggkp/docs/ggkp_moving_towards_a_common_approa.
- GoM, 2008. *Millennium Development Goals Based Comprehensive National Development Strategy of Mongolia*. Government of Mongolia Task force to develop comprehensive national development strategy, Ulaanbaatar City.
- Gurría, A., 2013. 'The climate challenge: Achieving zero emissions'. <http://www.oecd.org/about/secretary-general/the-climate-challenge-achieving-zero-emissions.htm>.
- Halsnaen, K., Callaway, L. and Meyers, H., 1999. *Economics of GHG Limitations. Main Report. Methodological Guidelines*. Available on the request from UNEP Collaborating Centre for Energy and Environment, Riso National Laboratory, Denmark.
- Heaps, C. B., 2012. *Long-Range Energy Alternatives Planning (LEAP) System*. Stockholm Environment Institute - U.S., Somerville, MA.
- Hertwich, E. G. and Peters, G. P., 2010. *Multiregional Input-Output Database: OPEN:EU Technical Document*. One Planet Economy Network, 7th Framework Programme for Research and Technological

Development, Trondheim, Norway.

http://www.oneplanetecomy.network.org/resources/programme-documents/WP1_MRIO_Technical_Document.pdf.

HSBC, 2012. *Coal and Carbon: Stranded Assets: Assessing the Risk*. HSBC Global Research, London. <https://www.research.hsbc.com/midas/Res/RDV?p=pdf&key=dXwE9bC8qs&n=333473.PDF>.

IEA, 2013. *World Energy Outlook 2013*. International Energy Agency, Paris. <http://www.worldenergyoutlook.org/publications/weo-2013/>.

IEA, 2012a. *Energy Technology Perspectives 2012: Pathways to a Clean Energy System*. International Energy Agency / OECD Publishing, Paris. <http://dx.doi.org/10.1787/20792603>.

IEA, 2012b. *World Energy Outlook 2012*. International Energy Agency, Paris. <http://www.worldenergyoutlook.org>.

IEA, 2011. *World Energy Balances 2011*. International Energy Agency, Paris. <http://www.iea.org/stats/>.

IEA, 2009. *Transport, Energy and CO₂: Moving towards Sustainability*. Paris.

IEA, 2007. *Tracking Industrial Energy Efficiency and CO₂ Emissions*. International Energy Agency, Paris.

IIASA, 2012. *Mongolia: Energy Profile and Policy*. Rapid Assessments. International Institute for Applied System Analysis.

IMF, 2013. *Energy Subsidy Reform: Lessons and Implications*. International Monetary Fund. <http://www.imf.org/external/np/pp/eng/2013/012813.pdf>.

IMF, 2012. *Mongolia: Staff Report for the 2012 Article IV Consultation and Third Post-Program Monitoring - Debt Sustainability Analysis*. International Monetary Fund.

Intergovernmental Panel on Climate Change, 2011. *IPCC Special Report on Renewable Energy Sources and Climate Change Mitigation*. O. Edenhofer, R. Pichs-Madruga, Y. Sokona, K. Seyboth, P. Matschoss, S. Kadner, T. Zwickel, P. Eickemeier, G. Hansen, S. Schlomer, and C. von Stechow (eds.). Cambridge University Press, Cambridge, UK.

Jarvis, M., Lange, G.-M., Hamilton, K., Desai, D., Fraumeni, B., Edens, B., Ferreira, S., Li, H., Chakraborti, L. and Kingmill, W., 2011. *The Changing Wealth of Nations: Measuring Sustainable Development in the New Millennium*. The World Bank, Washington, DC.

Johnson, T., Alatorre, C., Romo, Z. and Liu, F., 2010. *Low-Carbon Development for Mexico*. World Bank, Washington, DC.

Lenzen, M., Kanemoto, K., Moran, D. and Geschke, A., 2012. 'Mapping the Structure of the World Economy'. *Environmental Science & Technology*, 46(15). 8374–81. doi:10.1021/es300171x.

- Lkhagvadorj, I., 2010. *Mongolia Renewable Energy Report*. Asian and Pacific Centre for Transfer of Technology Of the United Nations – Economic and Social Commission for Asia and the Pacific (ESCAP), Ulaanbaatar.
- Maidowski, P., 2012. *How to Create Efficient, Reliable, and Clean Electricity Markets: A Regulatory Design for Mongolia and Northeast Asia*. Tufts University.
- MEGD, 2013a. *Green Civilization: Draft Strategic Plan for Green Development (English Translation)*. Ministry of Environment and Green Development, Government of Mongolia, Ulaanbaatar.
- MEGD, 2013b. *Technology Needs Assessment for Climate Change Mitigation in Mongolia*. Ministry of Environment and Green Development, Mongolia, Ulaanbaatar.
- Metz, B., 2013. 'Making a Pledge and Review system work: national green growth plans, policies and a different approach to equity | Controlling Climate Change'.
<http://controllingclimatechange.net/making-a-pledge-and-review-system-work>.
- Minchener, A., 2013. *Energy Issues for Mongolia*. IEA Clean Coal Centre.
- MNET, 2010. *Mongolia Second National Communication Under the United Nations Framework Convention on Climate Change*. Ulaanbaatar, Mongolia.
- Mudd, G. M., 2007. 'Global trends in gold mining: Towards quantifying environmental and resource sustainability'. *Resources Policy*, 32(1–2). 42–56. doi:10.1016/j.resourpol.2007.05.002.
- National Statistical Office of Mongolia, 2012. *Mongolian Statistical Yearbook*. Government of Mongolia, Ulaanbaatar, Mongolia.
- Ngwadla, X., 2013. *Equitable Access to Sustainable Development: Relevance to Negotiations and Actions on Climate Change*. MAPS.
- Norgate, T. and Haque, N., 2010. 'Energy and greenhouse gas impacts of mining and mineral processing operations'. *Journal of Cleaner Production*, 18(3). 266–74. doi:10.1016/j.jclepro.2009.09.020.
- OECD, 2012. *Green Growth and Developing Countries*. Paris.
- Oxford Business Group, 2013. *The Report: Mongolia 2013*. Oxford Business Group.
- Peters, G. P., 2008. 'From production-based to consumption-based national emissions inventories'. *Ecological Economics*, 65(1). 13–23. doi:10.1016/j.ecolecon.2007.10.014.
- Peters, G. P., Davis, S. J. and Andrew, R., 2012. 'A synthesis of carbon in international trade'. *Biogeosciences*, 9(8). 3247–76. doi:10.5194/bg-9-3247-2012.
- Sathaye, J. and Meyers, S., 1995. *Greenhouse Gas Mitigation Assessment: A Guidebook*. Kluwer Academic Publishers, Dordrecht, the Netherlands.

- Saygin, D., Worrell, E., Patel, M. K. and Gielen, D. J., 2011. 'Benchmarking the energy use of energy-intensive industries in industrialized and in developing countries'. *Energy*, 36(11). 6661–73. doi:10.1016/j.energy.2011.08.025.
- Song, J., 2013. 'North-East Asia Super Grid in Gobi desert'. Presented at the Expert Group Meeting on Conceptualizing the Asian Energy Highway, Urumqi, China.
- Temuulen, G., 2010. *Strategically Significant Mineral Deposits of Mongolia*. Erdenes MGL LLC.
- Tovuudorj, P., 2013. 'Mongolian National Energy Agenda and Policy Measures: Scope for subregional cooperation'.
- Tsendsuren, B., 2013. 'Expectation from New Market Mechanism in Mongolia: some concerns and possible project examples'.
- UN, 2013. *World Population Prospects: 2012 Edition*. United Nations Department of Economic and Social Affairs, Population Division, New York. <http://esa.un.org/wpp/>.
- UNDP, 2007. 'Energy Efficiency in New Construction in the Residential and Commercial Buildings Sector in Mongolia'.
- UNEP, 2011. *Towards a Green Economy: Pathways to Sustainable Development and Poverty Eradication*. United Nations Environment Programme, [Nairobi, Kenya].
- UNFCCC, 2012. *Training Handbook on Mitigation Assessment for Non-Annex I Parties*. United Nations Framework Convention on Climate Change, Bonn.
- UNIDO and Government of Mongolia, 2011. *Strategic Directions on Industrial Policy in Mongolia*. United Nations Industrial Development Organization, Vienna, Austria.
- UNWTO and UNEP, 2008. *Climate Change and Tourism: Responding to Global Challenges*. World Tourism Organization ; United Nations Environment Programme, Madrid; Paris.
- US DOE, 2007. *Mining Industry Energy Bandwidth Study*. Prepared by BCS Inc. for the U.S. Department of Energy Industrial Technologies Program, Washington D.C.
- USGS, 2012. *2011 Minerals Yearbook: Mongolia*. United States Geological Survey.
- Van der Ploeg, F., 2011. 'Natural Resources: Curse or Blessing?' *Journal of Economic Literature*, 49(2). 366–420. doi:10.1257/jel.49.2.366.
- Vivid Economics, 2009. *G20 Low Carbon Competitiveness*. The Climate Institute and E3G. <http://www.vivideconomics.com/index.php/publications/g20-low-carbon-competitiveness-report>.
- Weber, C. L. and Matthews, H. S., 2008. 'Food-miles and the relative climate impacts of food choices in the United States'. *Environmental Science & Technology*, 42(10). 3508–13. doi:10.1021/es702969f.

Westphal, M., Hughes, G. and Brommelhorster eds., 2013. *Economics of Climate Change in East Asia*. Asian Development Bank, Mandaluyong City, Philippines.

Winkler, H., 2007. *Long Term Mitigation Scenarios: Technical Report*. Prepared by the Energy Research Centre for Department of Environment Affairs and Tourism, Pretoria.

worldsteel, 2011. *Steel Statistical Yearbook 2011*. worldsteel Committee on Economic Studies, Brussels. <http://www.worldsteel.org>.

Yeren-Ulzii, B., 2012. 'Current and Future Prospects of the Electricity Sector in Mongolia'. <http://www.unescap.org/esd/Energy-Security-and-Water-Resources/energy/security/workingpmeeting/documents/Ulzii.pdf>.

Appendix A: Listing of the Members of the Project Advisory Committee

Name	Organization/Position
Guidance Team	
Mr. Tovuudorj Purevjav	Director General, Department of Strategic Policy and Planning, Ministry of Energy
Mr. Bekhbat Sodnom	Director General, Department of Innovation and PPP, Ministry of Economic Development
Mr. Angarag Myagmar	Head of Renewable Energy Division, Department of Policy Implementation and Coordination, Ministry of Energy
Ms. Tsendsuren Batsuuri	Head, CDM National Bureau, Climate Change Coordination Office, Ministry of Environment and Green Development
Mr. Enebish Namjil	Advisor to the Minister, Ministry of Energy
Mr. Chimeddorj Demchigjav (Project Key Contact Person)^	Head of Energy Division, Department of Policy Implementation and Coordination, Ministry of Energy
Technical Team	
Mr. Gerelt-od Tsogtbaatar	Officer, Climate Change Coordination office, Ministry of Environment and Green Development
Ms. Tegshjargal Bumtsend ^	Officer, Climate Change Coordination office, Ministry of Environment and Green Development
Mr. Tumenjargal Makhbal	Specialist in Charge of Policy in Renewable Energy, Department of Strategic Policy and Planning, Ministry of Energy
Mr. Atarjargal Tserendoo	Specialist in Charge of Energy Efficiency and Economic Modeling, Department of Strategic Policy and Planning, Ministry of Energy
Mr. Purevdash Solikhuu	Specialist in Charge of Solar Energy, Renewable Energy Division, Department of Policy Implementation and Coordination, Ministry of Energy
Ms. Gerel Jambaa	Officer, Department of Strategic Planning and Policy, Ministry of Energy
Ms. Ariunzul Dashjamts	Specialist in Charge of Environmental Impact Assessment, Fuel Division, Department of Policy Implementation and Coordination, Ministry of Energy
Ms. Javzanpagma N.*	Officer, Department of Innovation and PPP, Ministry of Economic Development
Mr. Misheelt Ganbold ^	Officer, Energy and Mining Policy, Ministry of Economic Development
Mr. Enkh-Amgalan Davaa-Ochir	Specialist, National Renewable Energy Center
Mr. Enkhsaihan Tumen-Ulzii	Engineer, Mongolian Energy Association
Local Consultant Team	
Dr. (Mr.) Dorjpurev Jargal	Director and senior consultant, EEC Co., Ltd
Mr. Sukhbaatar Tsegmid	Senior Advisor, Necom Group, and Director, Mongolian Energy Association
Ms. Oyunchimeg Chogdon	Project Manager, Local Consultant Team

* Participated in first Project Meeting; subsequently moved to another organization

^ Participated in Project starting in third project meeting

^^ As of December, 2013, promoted to Director of Combined Heat and Power Plant #3, Ministry of Energy

Appendix B: Approaches to accounting for GHG emissions

Mongolia's greenhouse gas inventory, like all inventories submitted by countries to the United Nations Framework Convention on Climate Change (UNFCCC), is based on the emissions released within the country. Using this "territorial" approach, Mongolia's emissions are dominated by CO₂ from power generation, methane (CH₄) from enteric fermentation, and (to a lesser extent) combustion of fossil fuels in vehicles and buildings. Counting these emissions for Mongolia makes sense, because government policy, especially policies on Mongolia's energy supply, can affect releases of these GHGs within the country. Existing targets for carbon intensity and carbon productivity are based on this territorial GHG inventory.

There are other ways to account for GHG emissions that offer important added perspectives on sustainable development as well as on competitiveness in a low-carbon world. For example, a carbon "footprint", or consumption-based accounting of emissions, can provide a fuller understanding of the impact of Mongolian households on global GHG emissions. A consumption-based inventory attributes the emissions associated with producing and delivering goods and services to households (and countries) that consume them, rather than to the businesses (and countries) that produce and transport them. For example, energy is used to make computers, appliances, household items, and other goods purchased and used in Mongolia, many of which are made in other countries. A consumption-based GHG inventory is therefore a relevant approach to use in the context of "green consumption" objectives, as has been considered in the development of Mongolia's green development concept (which, in mid-2013, when this appendix was drafted, was being called *Green Civilization*.)

Counting the GHG emissions associated with making the goods and services consumed in Mongolia requires a different set of analytical tools than those used to compile a traditional GHG inventory (Peters 2008). Techniques to calculate *consumption-based inventories* have advanced considerably in recent years, and it is now possible to develop them for countries such as Mongolia (Lenzen et al. 2012).

Current patterns of economic growth in Mongolia are strongly dependent on exports from energy-intensive mining. One of Mongolia's most significant exports – coal – also creates CO₂ emissions in the countries that import and burn it. This suggests a third possible way of accounting for GHG emissions – one associated with production and trade in fuels. In fact, such a system has been proposed, and is gaining some traction (Davis et al. 2011; Peters et al. 2012). Furthermore, accounting for the emissions associated with fuel production and trade can provide an indicator of potential risks associated with a future low-carbon economy. In addition to being subject to cyclical price variations independent of environmental

considerations, future global coal markets may also be strongly affected by international efforts to address greenhouse gas emissions – such as limits or taxes on coal consumption – that could reverse the global growth in consumption and introduce risks to countries, including Mongolia, that are highly dependent on coal exports for economic growth. In fact, for various reasons, China has recently introduced caps on coal use in a number of regions, and is contemplating a national cap on coal use.

The International Energy Agency has outlined a range of possible future scenarios of coal demand. These scenarios range from continued growth in demand, to one where global coal use peaks before 2020 and declines steadily after that (IEA 2012b). As shown in Figure B-1, recently announced (“New”) policies in major economies have lowered the IEA’s forecasts of future coal demand, and further action by countries to address greenhouse gas emissions, through caps on coal usage (as in China), carbon pricing (as in Europe and under development in China), and other measures (such as emissions limits on new power plants, such as in the United States) could lead to declining coal demand, as in the IEA’s 450 ppm scenario.

Figure B-1. Scenarios of Global Coal Demand (IEA 2012b)

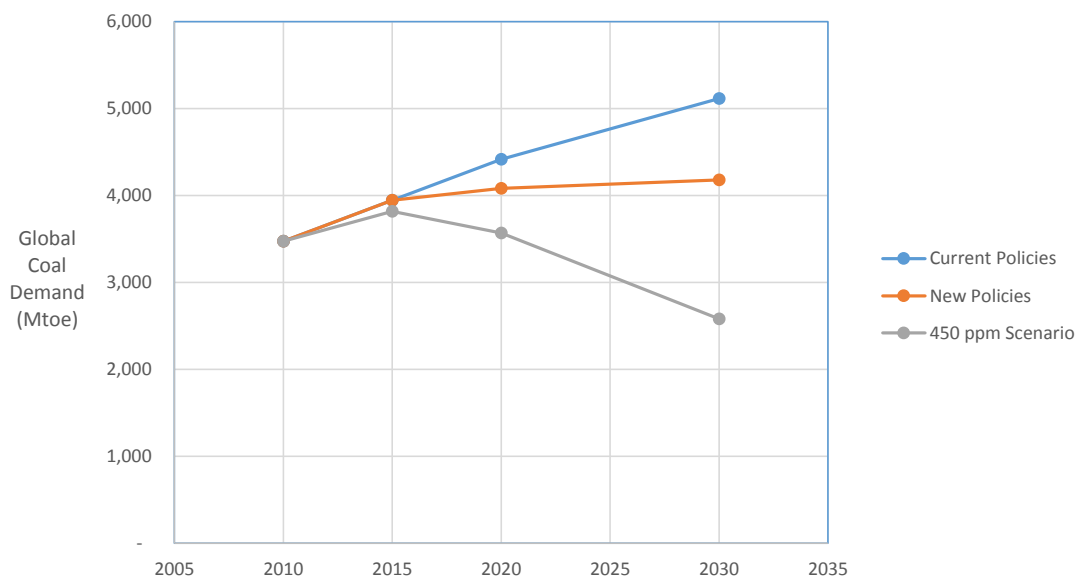

Counting the emissions associated with exports of fuels produced within a given country (especially coal) could thus provide an indicator of the associated risks should major economies begin to limit coal use as in the IEA’s 450 ppm scenario above, while providing another, complementary means to track a country’s contribution to global GHG emissions. For example, in 2010, Mongolia exported 594,000 TJ of coal (IEA 2011), which, when burned in the

destination countries, released an estimated 59 million tons CO₂, several times more CO₂ than released from energy consumption inside Mongolia. If major economies were to take a path similar to that in the IEA's 450 ppm scenario above, these emissions could be subject to limits or carbon prices, demand for coal could decline, and with falling prices, countries with economies highly dependent on coal and other high-carbon exports could be exposed to much greater economic risk and, potentially, stranded assets (Carbon Tracker Initiative 2011). In contrast, economies that develop low-carbon energy systems and low-carbon exports may benefit from a higher degree of "low-carbon competitiveness" if major economies take serious action to address climate change (Vivid Economics 2009). Note that accounting for emissions associated with energy exports is already standard practice for electricity, for which emissions associated with electricity produced within a given country are included in the usual, territorial UNFCCC inventory even if exported.

The range of possible global scenarios for coal markets may be of particular concern to Mongolia, where coal production has grown rapidly as a share of Mongolia's GDP, as indicated in Figure B-2.

**Figure B-2. Natural Resource Rents in Mongolia as a Function of National GDP
Based on Data from the World Bank (Jarvis et al. 2011)**

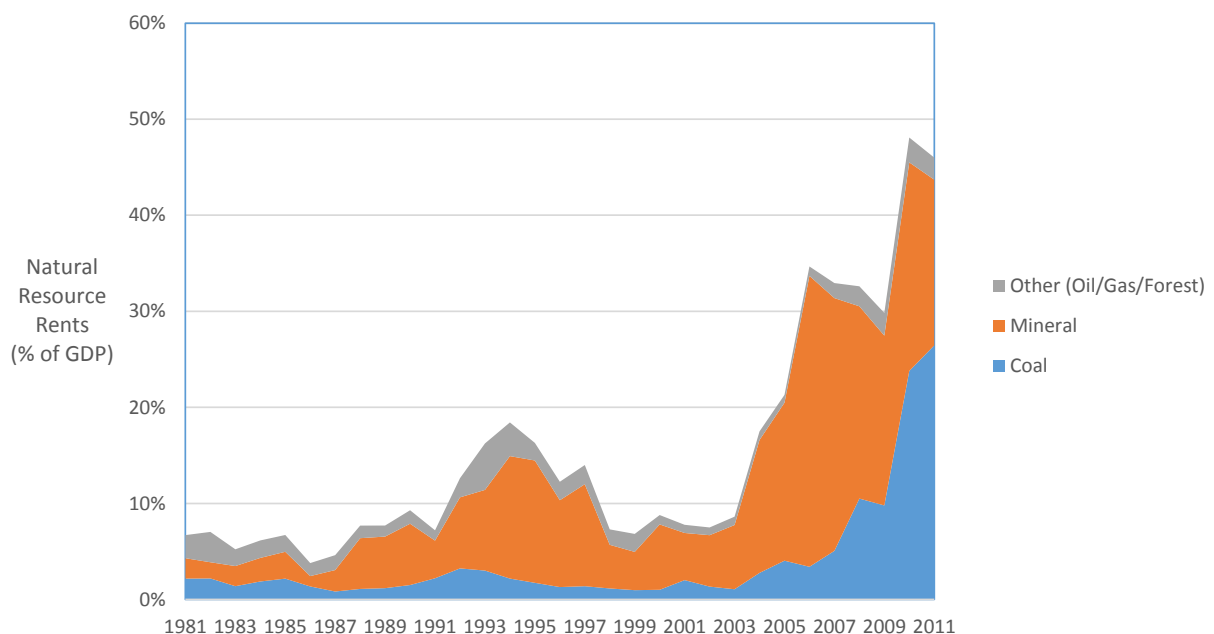

Furthermore, climate change concerns aside, reliance on natural resource extraction has not always led to long-term economic growth in major economies – and sometimes has proved a hindrance (Barma et al. 2011; van der Ploeg 2011). As Mongolia is among the most resource-dependent economies (and by far the most coal-export-dependent economy) in the world,

economic diversification will likely be necessary (Minchener 2013), as will means to invest the resource rents (economic profits) into other sectors.

Box B-1: Comparing the Three Perspectives on GHG Emissions

The **territorial**, **consumption**, and **extraction**-based approaches are not mutually exclusive and, in some cases, have considerable overlaps. For example, CO₂ from fossil fuels extracted in a country and used for home heating in the same country would show up in all three accounts. In Mongolia, this could be steam coal mined in the country and burned for heat in gers or coal burned to provide heat indirectly, e.g. through the use of CHP district heating in Ulaanbaatar.

Broadly speaking, methods for all three approaches are to multiply fuel or activity data by emission factors for each. In a territorial inventory, this involves multiplying fuel consumptions statistics with the carbon content of those fuels with methods and default data set forth by the IPCC. (Methods for other territorial sources vary somewhat, such as for animal methane, which involves multiplying the number of livestock by expected emissions from each.) Consumption-based inventories are assembled by multiplying consumption data (usually economic spending, e.g. in USD) by the emissions intensity of that consumption (e.g., CO₂ per USD) based on economic models. Extraction-based accounting is performed by multiplying the fuels produced by the carbon content of those fuels.

The figure below describes the major categories of emissions in each approach, and the overlaps among them.

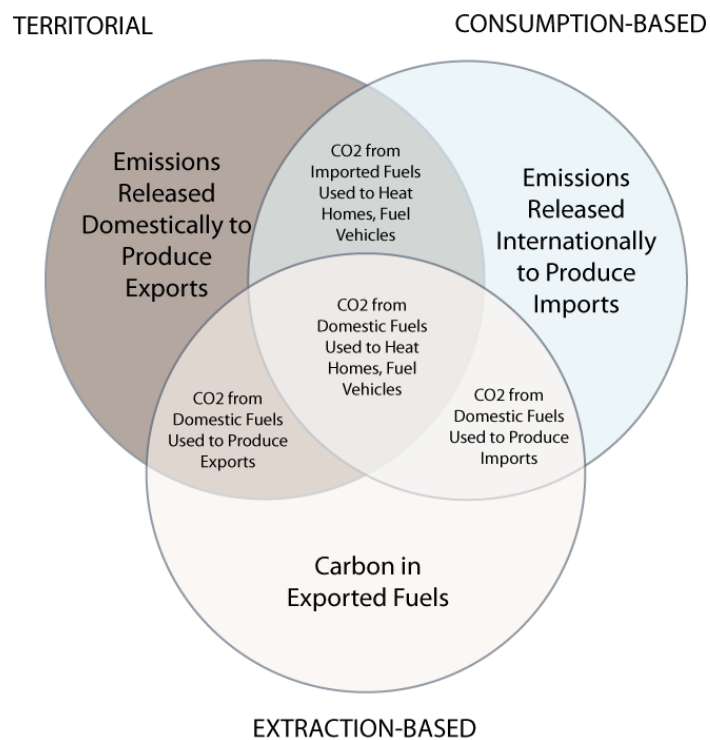

Implications for Green Growth and Sustainable Development Planning

Based on the research outlined above, we suggest that Mongolia may wish to expand its current focus on territorial CO₂ emissions and emissions intensity to include additional metrics and goals for *consumption-based* and *extraction-based* emissions.

Recent advances in data availability have enabled the preparation of estimates of GHG emissions for each of these three approaches (Peters et al. 2012). (For a brief summary of each method, see Box B-1.) Here, we estimate energy-related CO₂ for each approach for Mongolia, based on data for 1990-2008 compiled in the global Eora database (Lenzen et al. 2012) and on coal extraction statistics for Mongolia published by the International Energy Agency (IEA 2011). . Figure B-3, below, presents time-series results for each approach on the same graph.

Figure B-3. Energy-related CO₂ for Mongolia in Territorial, Consumption, and Extraction-based Accounting Approaches

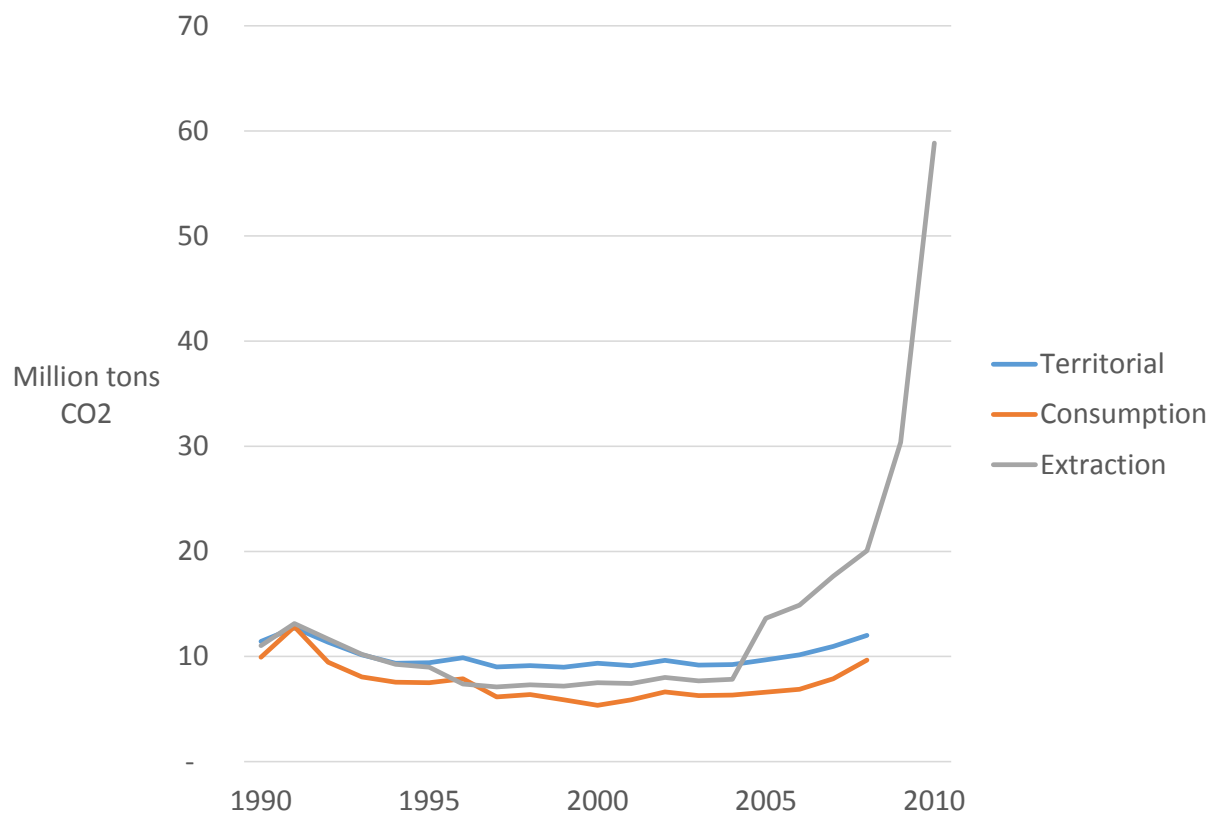

As Mongolia develops its approach to sustainable development and green growth, it could track the metrics above and take measures to reduce the GHGs or GHG-intensity of its economy by each metric. This study finds that Mongolia could reduce its CO₂ emissions by over one third relative to reference-

case projections in 2035. Other policy and technical measures may be needed to reduce the intensity of consumption and extraction-based emissions. Some of these are summarized in Table B-1 below.

Table B-1. Possible Measures to Reduce Territorial, Consumption, and Extraction-based GHG Emissions
(⇓ = measure would reduce emissions relative to BAU)

Measures	Impact on GHG emissions relative to business-as-usual			Effect on Economic Growth
	Territorial	Consumption	Extraction	
Renewable Energy for Domestic Use	⇓	⇓	⇓ (coal prod down)	Uncertain
Renewable Energy for Export	⇓	⇓ (if energy exported to countries that export products make to Mongolia)	⇓ (GDP up, coal prod same)	Could increase economic growth via increasing exports
Energy Efficiency in Households and Government	⇓	⇓	⇓ (GDP same or up, coal prod down)	Uncertain; could increase due to energy savings
Energy Efficiency in Services and Industry	⇓	⇓	⇓ (GDP same or up, coal prod down)	Uncertain; could increase due to energy savings
Low-carbon consumption (purchase of low-GHG goods and services)	⇓	⇓		Uncertain
Emphasize economic growth in non-extractive sectors	Uncertain		⇓ (if coal extraction lower than BAU)	Could lead to more resilient economy in long term, perhaps at expense of near term economic growth, particularly growth of fossil fuel exports

In summary, Mongolia has considered GHG emissions and GHG-intensity (CO₂e per unit GDP) as core metrics in its sustainable development planning, as well as in its prior (and currently in-process) National Communications to the UNFCCC (MNET 2010). These metrics usually considers primarily only territorial greenhouse gas emissions. We suggest that measures of territorial GHG emissions continue, and that Mongolia also introduce accounting for *consumption* and *extraction*-based GHG emissions to more completely track Mongolia's contribution to global greenhouse gas emissions, as well as to help assess possible financial risks associated with being overly reliant on exports of fuels (especially coal).

Appendix C: Possible Green Growth Indicators for Mongolia

No universal definition of green growth exists, but key international institutions working in this area -- GGGI, the United Nations Environment Programme (UNEP), and the Organization for Economic Cooperation and Development (OECD) – all emphasize improvement in human well-being while sustaining natural resources (GGGI 2011; UNEP 2011; OECD 2012).

Together with the World Bank, these institutions have worked through the Green Growth Knowledge Platform (GGKP) to translate the concept of green growth into a common set of metrics to measure and track progress, in the following five categories (GGKP 2013):

- Natural asset base, such as whether natural resource stocks are being depleted;
- Environmental and resource productivity / intensity, such as measures of economic activity (GDP) per unit of emissions (CO₂);
- Environmental quality of life, especially the fraction of the population exposed to air pollution;
- Policies and economic opportunities, which may affect indicators in any of the three categories above, and which may include environmentally related taxes or subsidies that stand in the way of cleaner production and consumption, as well as measures to shift the structure of the economy;
- Socio-economic context, such as standard macroeconomic variables, and measures of equity, social inclusion, and access to services.

In the table below, we describe and develop a few of the indicators that appear relevant to Mongolia's existing goals on expansion of renewable energy, reduction in CO₂-intensity, and improvement of air quality, all of which are also themes of this project.

Table C-0-1. Selected indicators of Green Growth from Green Growth Knowledge Platform (GGKP 2013)

Indicator category	Indicator	Relation to major initiatives in Mongolia	Possible questions to consider for Mongolia
Natural asset base	Available (global) stocks or reserves of selected minerals	Mining of copper and coal are the major sources of economic growth in Mongolia	To what extent mining assets support or hinder green energy growth objectives
Environmental and resource production / intensity	GDP/CO ₂ e or CO ₂ e/GDP	Similar to indicators proposed by MEGD in <i>Green Civilization</i> (MEGD 2013a) and <i>Second National Communication</i> (MNET 2010)	How to define GHG intensity or productivity in a manner that represents progress toward green growth at both national and global levels
	Share of renewable energy in electricity supply or primary energy	Aligns with the renewable energy program goal of 20% to 25% renewables in primary energy by 2020	If and how to assess CO ₂ benefit of renewable energy export suggested by President Tsakhia Elbegdorj ³⁶ and Minister of Energy Sonompil (Oxford Business Group 2013, p.135)
Environmental quality of life	Share of population exposed to health-threatening levels of PM _{2.5}	Aligns with national goal to reduce urban air pollution, including the 2012 <i>Mongolian Law on Air</i>	If and how to assess the air quality impacts of alternative energy scenarios or technologies
Policies and economic opportunities	Fossil fuel taxation	May align with proposals to tax mining to support other sectors and affected communities ³⁷	If and how to quantify CO ₂ and other effects (e.g., social benefits) of tax and subsidy reform
	Energy prices and fossil fuel subsidies	Mongolia currently has among the highest fossil fuel subsidies in the world (IMF 2013)	[Same as above]
	Renewable energy incentives	Aligns with 2007 <i>Renewable Energy Law</i> , especially feed-in tariffs	None identified
	GDP growth and structure	National strategy to increase GDP (GoM 2008); President, Prime Minister, and MEGD goals to grow share of non-mining sectors (Oxford Business Group 2013, pp.17–18; MEGD 2013a)	Method for identifying sectors that would contribute to green growth
Socio-economic context	Access to electricity	Aligns with ger electrification initiatives, e.g. 100,000 Solar Gers	None identified
	Employment rate	Aligns with goals to increase employment rate (GoM 2008) and create “green” jobs (MEGD 2013a)	Extent to which development of green energy systems can affect employment in Mongolia

³⁶ <http://www.rtcc.org/mongolias-green-gold-revolution-in-un-spotlight/>

³⁷ <http://in.reuters.com/article/2013/06/05/mongolia-mining-idINDEE95408920130605>

Based on a review of these indicators, several issues may warrant further consideration for energy planning in Mongolia. These are listed in the last column of Table C-0-1. We discuss each below:

- **Extent to which mining assets support or hinder green growth objectives.** Proposals have been advanced in Mongolia to use economic gains from the mining sector to support other environmental and social objectives in the country. Questions to consider may include, for example, what is the scale of tax revenues or other economic rents that could be made available to support energy efficiency and renewable energy, increased electricity access in rural areas, cleaner cooking and heating fuels in urban areas, increased employment in “green” vocations, or other social or green energy initiatives? Or, instead, does large-scale development of coal resources (even if primarily for export) drive down coal prices to the extent that renewable energy cannot compete domestically?
- **How to define GHG intensity or productivity in a manner that represents progress toward green growth at both national and global levels.** Mongolia’s targets for carbon intensity (and its inverse, carbon productivity) are based on a “territorial” accounting for greenhouse gas emissions that counts emissions released within Mongolia. Actions to decrease GHG-intensity within Mongolia may have significant impact on GHG emissions outside the country’s borders, however (e.g., through carbon “leakage”) (GGKP 2013). Two means to account for GHG emissions can be used to help provide a more complete picture of a country’s contribution to global GHG emission: a *consumption* and an *extraction* approach. A consumption-based approach (also called a carbon “footprint”) would count the emissions associated with producing goods and services consumed in Mongolia (even if those goods were imported). An extraction-based approach would track emissions associated with the eventual combustion of exported fuels (e.g., coal), which could help provide an indicator of possible financial risks to the country’s growth, as emissions from burning these fuels could be subject to limits or carbon prices in the importing countries, such as caps on coal usage in China. Using these other two approaches can help design strategies that result in global (not just local) reductions in GHG emissions (or intensity).
- **If and how to assess the CO₂ benefits of renewable energy exports.** Several figures in the Mongolian government have suggested that Mongolia could develop solar and wind power for export, e.g. to China or to a proposed broader Asian “supergrid.” Such developments could contribute to economic development in Mongolia, but reductions in emissions through use of the renewable energy exported would occur in other countries. Assessing the emissions benefits of expansion of Mongolian renewable energy for export would involve, at a minimum, consideration of what energy sources were being displaced in the importing countries.
- **If and how to assess the air quality impacts of alternative energy scenarios or technologies.** Quantifying the GHG emissions associated with different energy technologies is relatively straightforward; emissions of other pollutants, such as particulates including PM_{2.5}, can depend on specific control technologies. Furthermore, where the other pollutants are released – such as near population centers – can have a great impact on the potential health impacts. If and how to assess these impacts quantitatively – or, alternately, qualitatively – as

well as whether to make reduction in particulate emissions an explicit goal of the scenarios (which could increase energy use) – will need to be addressed.

- **If and how to quantify potential CO₂ and other effects (e.g., social benefits) of tax and subsidy reform.** Discussions are underway in Mongolia about if and how to reform fossil fuel taxation to support investments in renewable energy, other types of business, and social initiatives. Changing the pricing structure of fossil fuels, whether directly through taxes or instead through removal of subsidies (Mongolia has among the world's highest subsidies on fossil fuels), could have an impact on fossil fuel consumption and CO₂ emissions. Quantifying these potential CO₂ effects would need to involve an economic model or, at a minimum, assumptions about economic elasticities to estimate demand response to changes in prices.
- **Method for identifying sectors that would contribute to green growth.** The mining sector has dominated Mongolia's recent economic growth, and goals have been announced to grow other economic sectors, such as agriculture. Yet it is not clear which sectors would contribute to green growth. Efforts to identify and evaluate economic sectors that would contribute to green growth face several questions, such as potential impact on national and global GHGs, air pollutants, and a host of other green growth indicators (GGKP 2013), as well as whether the necessary knowledge and other factors are in place in Mongolia for the target sectors to grow. Some sectors, such as livestock for food or wool, may have low energy-intensity but potentially high GHG-intensity (in this case, due to methane emissions from ruminant animals). Other sectors may have relatively low (local) energy intensity (per unit of GDP produced), but substantially contribute to global GHG emissions (e.g., international tourism, or coal mining). And some sectors may have other economic or social impacts, positive or negative, beyond GHG emissions. Developing a method to screen and evaluate sectors, taking into account these types of considerations, could be challenging.
- **Extent to which development of green energy systems can affect employment in Mongolia.** Several studies have suggested the development of renewable energy creates more jobs per unit of energy created than does development of fossil energy (UNEP 2011). However, the methods to analyze employment effects are challenging and require an assessment of how the full supply chain (from production of equipment and parts to labor for installation) would adjust in both the medium and long term (IPCC 2011). Whether to assess employment potential quantitatively using such methods, or instead describe the potential (and needed supporting policies and institutions) qualitatively, is an open question for this project.

Addressing all of these questions would require a substantial resource effort, likely over many years. In this report, we address the first four questions only, leaving the other questions to future work or related efforts.

Appendix D. Ministries and Agencies Responsible for Renewable Energy in Mongolia

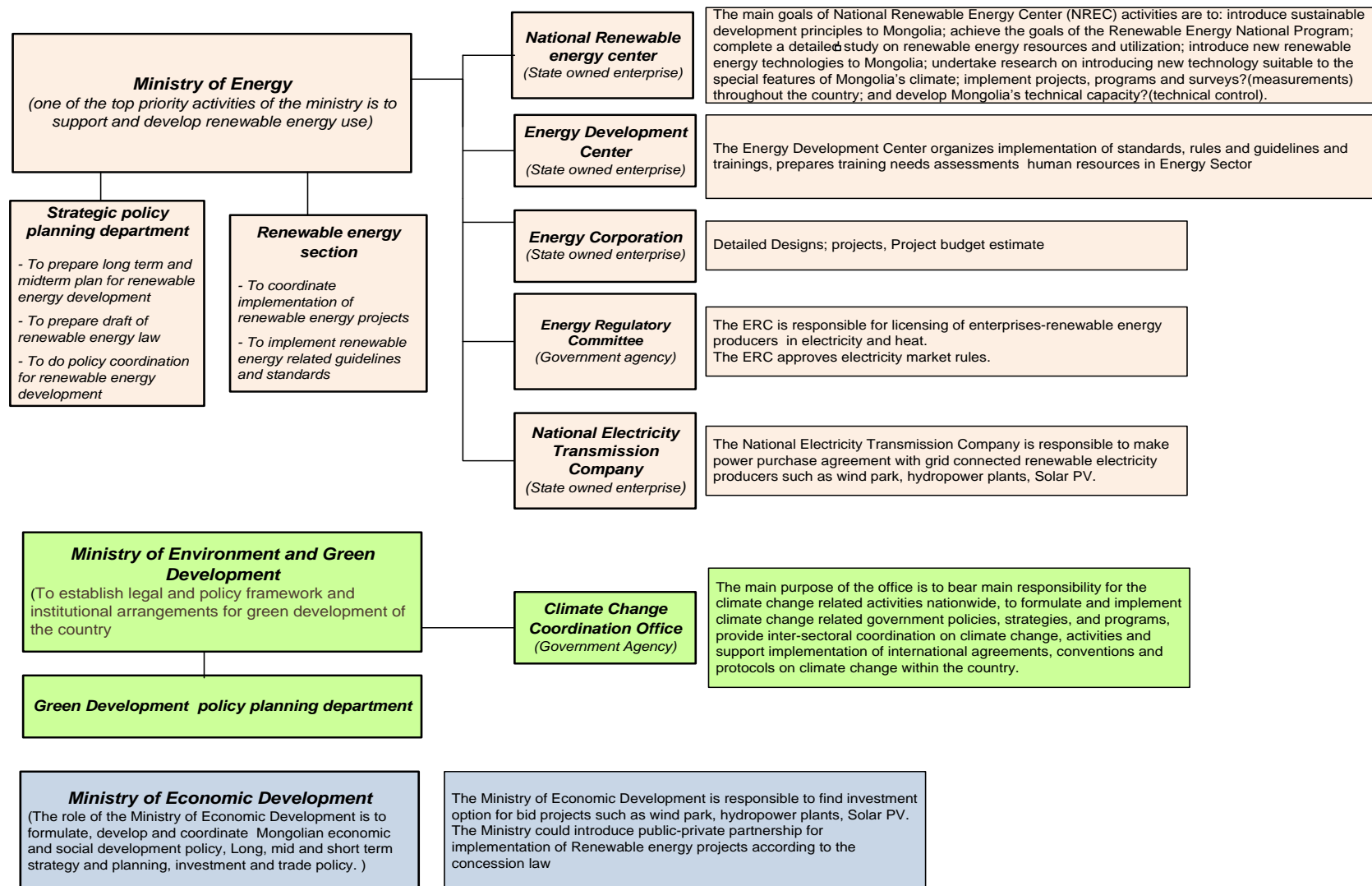

Appendix E: Listing of LEAP Scenarios in Mongolia Data Set

The table that follows provides a brief listing of the individual sub-scenarios included in the Mongolia LEAP (Long-range Energy Alternatives Planning) dataset developed for the “Strategies for Development of Green Energy Systems in Mongolia” Project. The discussion in the body of this report has focused on the results for four overarching scenarios: “Reference”, “Recent Plans”, “Expanded Green Energy”, and “Shift in Energy Exports”. With the exception of the Reference case, each of these scenarios is in turn built up from a number of individual LEAP sub-scenarios, each starting from the Reference case, that focus on the application of green energy measures to change the reference case in, for example, a particular demand end-use or a particular energy supply process. In some cases, intermediate scenarios were used to collect a group of individual scenarios (for example, “Green Energy Demand-side Measures”), and the intermediate scenarios were included in the overarching scenarios.

The tables that follows provides the LEAP codes used to refer to individual LEAP scenarios, the title of the scenarios as used in LEAP, a brief description of each scenario, and, where applicable, a “mapping” of how the individual LEAP sub-scenarios are combined (“inherited”) into composite or overarching scenarios.

<u>Overarching Scenarios</u>			
LEAP Code	Title	Inherits from	Description
CA	Current Accounts	[None]	Describes energy supply and demand in Mongolia in the base year (now 2010) and, in some cases, previous years.
REF	Reference	Current Accounts	Describes reference-case changes in Mongolia’s energy sector. Includes fossil power plant additions and upgrades as planned (e.g., CHP5, Tavan Tolgoi, Telmen), plus renewables that are already in operation (e.g., Salkhit Wind Park); heat provided by CHP and coal-fired heat-only boilers. In the energy demand sectors, includes expected trends towards gradually less energy-intensive end-use technologies.

RPL	Recent Plans	BUI, Lighting, HEC	For electricity generation, includes the large planned Sheuren hydropower plant and additional wind power as in Energy Sector Master Plan; plus application of pulverized coal combustion technologies. In energy demand, includes implementation of efficient lighting and improved insulation of panel apartment buildings, as suggested in the Technical Needs Assessment.
EGE	Expanded Green Energy All	GRE, REN, Own, ASC, HOB, T&D, OIL, ECI, HEC	Includes application of all demand-side green energy measures modeled, plus expanded use of renewable power and other supply-side improvements including reduced transmission and distribution losses and electricity plant own-use,
SEE	Shift in Energy Exports	EGE	Green energy exports scenario includes rapid ramp-up of solar PV power systems in the Gobi region (at an average of 60% per year after 2017, similar to rate of growth of deployment in China), with a corresponding target for exports of electricity, and a corresponding reduction in the exports of coal from Mongolia, such that most coal exports are displaced by 2035. Demand-side use of electricity in coal mining is also reduced. In other respects, this scenario inherits from the Green Energy Scenario.

Intermediate Scenarios

LEAP Code	Title	Inherits from	Description
GRE	Green Energy Demand Side Measures	MEI, INC, INE, SWH, VEH, TRA, BNG, RBS, APP, CSG, GHI, Lighting, BUI, URB, GHB, GH3	Combines green energy measures from the buildings, transport, industrial, and agricultural sectors.
REN	Renewable	HYDRO, SOL, WIND	Combines electricity generation additions from renewable energy sources (hydroelectric, solar photovoltaic/thermal, and wind power)

Individual Scenarios

LEAP Code	Title	Description
APP	Appliance Efficiency	Efficiency improvements in multiple electric appliances, including in power supplies for electronics.
ASC	Advanced Ultra Supercritical	Implements higher-efficiency new coal plants when additional electricity supplies (beyond those provided through other plants in the scenario) are needed.
BNG	CNG Bus Implementation	Implementation of CNG bus use in Ulaanbaatar based on GGGI Transport study (2013).
BUI	Building Energy Efficiency	Improvements in building energy efficiency (residential and commercial sectors) related mostly to space heating.
CMM*	Coal Mine Methane Capture	Capture of methane from coal mines/coal beds.
CSG	Efficient Ger Coal Stoves	Implementation of efficient coal stoves for gers.
ECI	Existing CHP Efficiency Improvements	Improvements to boost the performance of existing CHP units in the power sector.
GHB	Ger Heating Blanket Program	Applies heating blankets (additional insulation) to gers in urban and rural areas.
GHI	Ger Heating Improvement	Improvements in coal briquette and wood-fired ger heating stoves.
GHS	Ground Source Heat Pumps (Revised)	Phases in ground-source heat pumps for space heating in urban houses and in the commercial sector.
HEC	Higher Efficiency New Coal Plants	Implements higher efficiency standards for new coal and CHP plants--assumed 3% or greater improvements in electricity generation efficiency than conventional plants in reference case.
HOB	HOB Improvement	Improvements in the efficiency of heat-only boilers providing district heat in urban and soum areas.
HYDRO	Hydro Power	Additional hydroelectric power plant development beyond

LEAP Code	Title	Description
	Expansion	reference case levels.
INC	Industrial Coal and Heat Use Measures	Measures to improve coal-fired boilers and furnaces and reduce industrial heat use.
INE	Industrial Electric Measures	Implements energy efficiency improvements in industrial electricity use.
Lighting	Efficient lighting	Lighting efficiency improvement measures in buildings sectors.
MEI	Mining Energy Intensity Improvement	With the exception of the newest mines and minerals processing plants, assumes transition to current best practice energy electricity and fuel-use intensities by 2020, with improvement to current “practical minimum” energy intensities by 2035 in all subsectors.
OWN	Station own use	Reduction in the “own use” of electricity in electricity generation plants.
RBS	Road Transport Mode Shift	Shifting passengers from private vehicles to buses. Based on four strategies in the GGGI Transport study (2013) and the modeled efficacies of same, implementation of BRT, improvements in operations, and improved fare systems yield about 15% shift of private road vehicle trips from cars to buses by the year 2020.
SOL	Solar PV	Addition of solar photovoltaic and solar thermal power (supply-side).
SSH	Soum Solar Heating	Addition of solar heating for groups of households in soums.
SWH	Solar Water Heating	Solar water heating applications in apartments, gers, and the commercial sector.
TRA	Transport mode shift to Rail	Shifts transport for passenger and freight transport to rail from road and air travel.
T&D	Transmission and distribution losses	Reduction in transmission and distribution losses for electricity, and distribution losses for heat.
URB	Urban Planning to Reduce Travel	Urban planning measures undertaken to reduce growth in requirements for personal and other travel.

LEAP Code	Title	Description
	Demand	
VEH	Vehicle Efficiency Improvement	Improvements in road vehicle efficiency, including improvements in gasoline and diesel vehicles, and some implementation of electric vehicles.
WIND	Wind Park	Additional wind power development.

*Note that this scenario/measure has been included in the cost curve shown in this report, but is not yet included in any of the overarching scenarios.

Appendix F: Summary Description of LEAP Software Tool

LEAP, the Long range Energy Alternatives Planning System, is a software tool for energy policy analysis and climate change mitigation assessment developed at the Stockholm Environment Institute.

LEAP has been adopted by thousands of organizations and many thousands of individual researchers and analysts in more than 190 countries worldwide. Its users include government agencies, academics, non-governmental organizations, consulting companies, and energy utilities, and it has been used at scales ranging from households, factories, cities and states to national, regional and global applications.

Countries use LEAP to undertake integrated resource planning, greenhouse gas (GHG) mitigation assessments, and Low Emission Development Strategies (LEDS) especially in the developing world. Many countries have also chosen to use LEAP as part of their commitment to report to the U.N. Framework Convention on Climate Change (UNFCCC).

In comparison to the other tools for energy and environmental planning, which may have more sophisticated energy modeling capabilities, but are harder to use and more data intensive, LEAP's focus is on transparency of results, ease-of-use, data flexibility, adaptability to different scales, powerful data & scenario management and policy-friendly reporting. LEAP is also notable for the degree of methodological choice that it provides to its users, as well as for the ability to link to other models and software, including LEAP's sister program for water resource planning, the water or WEAP, as well as the MS-Office programs, and through its advanced programming interface, with other models that users might already be using.

Integrated Planning

LEAP is an integrated modeling tool that can be used to track energy consumption, production and resource extraction in all sectors of an economy. LEAP is a demand-driven tool, in that the user first describes current and future energy requirements for households, transport, industry, and other sectors, then uses LEAP to model processes such as electricity generation, coal mining, and other energy supply systems that provide fuels for final consumption. It can be used to account for both energy sector and non-energy sector greenhouse gas (GHG) emission sources and sinks. In addition to tracking GHGs, LEAP can also be used to analyze emissions of local and regional air pollutants, making it well-suited to studies of the climate co-benefits of local air pollution reduction. Finally, LEAP can track the direct costs of fuels and resources, of devices and systems that use energy, and of energy supply infrastructure so as to estimate the relative costs of different approaches to providing

energy for an economy. The diagram below shows the relationships of the different integrated elements of the LEAP structure, and of the calculation flows within LEAP.

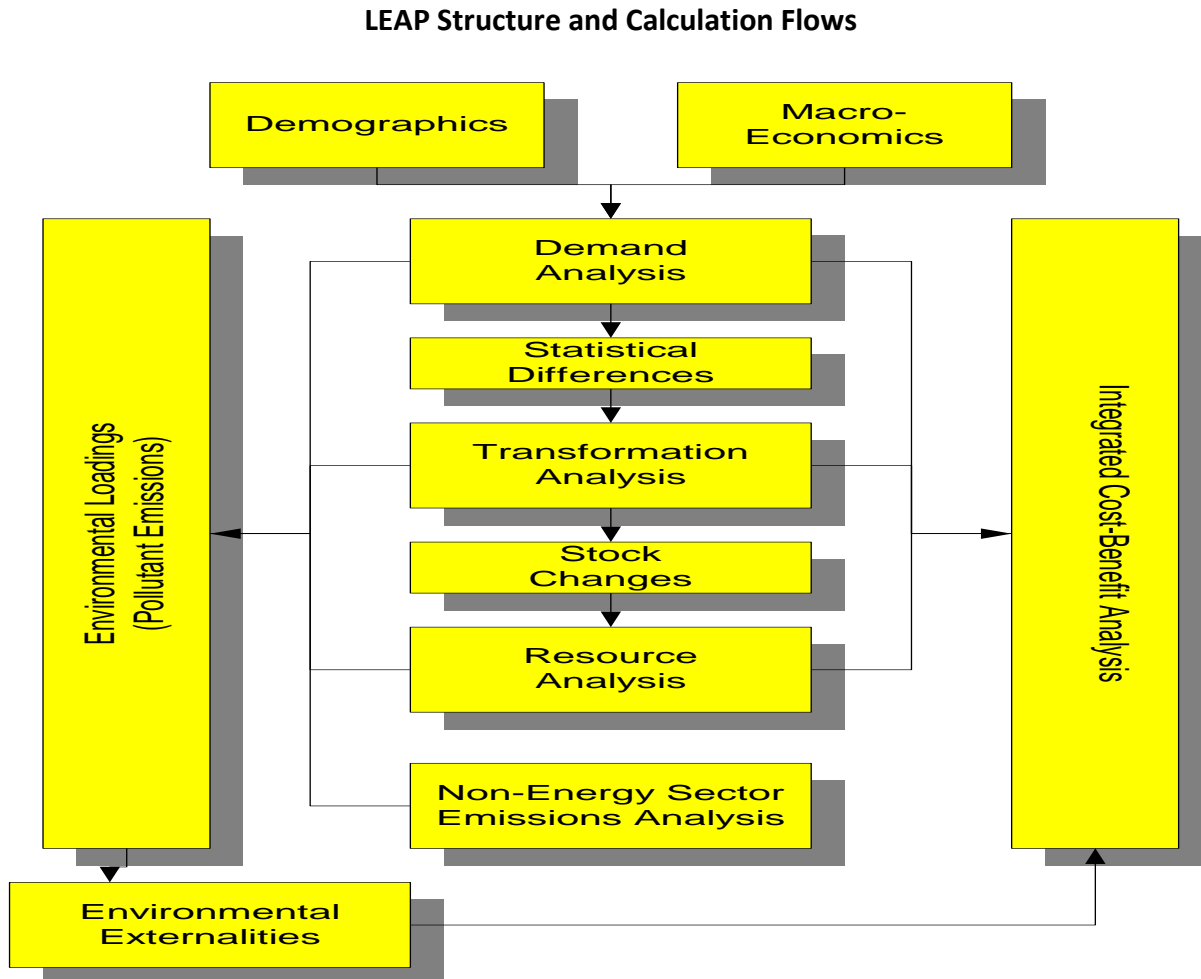

Flexibility and Ease-Of Use

LEAP has developed a reputation among its users for presenting complex energy analysis concepts in a transparent and intuitive way. At the same time, LEAP is flexible enough for users with a wide range of expertise: from leading global experts who wish to design policies and demonstrate their benefits to decision makers to trainers who want to build capacity among young analysts who are embarking on the challenge of understanding the complexity of energy systems.

Modeling Methodologies

LEAP is not a model of a particular energy system, but rather a tool that can be used to create models of different energy systems, where each requires its own unique data structures. As a demand-driven

tool, analysis of energy consumption and its associated costs and emissions in an area is organized into a flexible hierarchical tree structure of energy demand, which is typically organized by sector, subsector, end-use and device. A user-created tree structure such as that shown below, is the main data structure used for organizing data and models, and for reviewing results. Within the tree, icons indicate the types of data (for example, categories, technologies, fuels and environmental effects). Users can edit the tree on-screen using standard editing functions (copy, paste, drag & drop). The structure created by the user can be detailed and end-use oriented, or highly aggregate (e.g. sector by fuel), and the level of detail can vary from sector to sector as appropriate to adjust to data availability and to modeling goals. LEAP supports a wide range of different modeling methodologies: on the demand side these range from bottom-up, end-use accounting techniques to top-down macroeconomic modeling. LEAP also includes a range of optional specialized methodologies including stock-turnover modeling for areas such as transport planning.

An Example of the LEAP “Tree” Structure for Demand

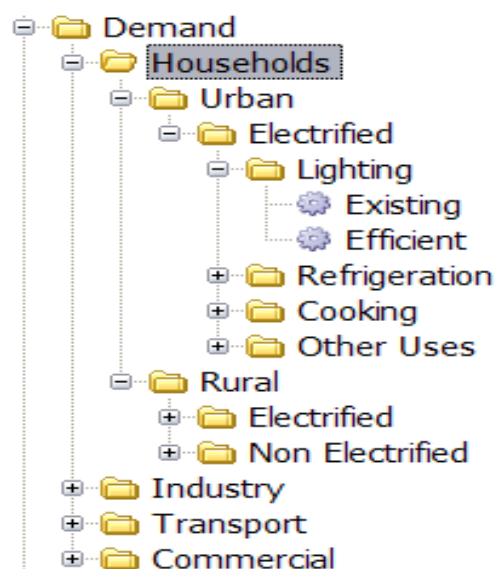

On the supply side, LEAP provides a range of accounting and simulation methodologies that are powerful enough for modeling electric sector generation and capacity expansion planning, but which are also sufficiently flexible and transparent to allow LEAP to easily incorporate data and results from other more specialized models.

On the energy supply side (conversion of resources or intermediate products into intermediate products or end-use fuels), the LEAP Transformation program provides for integrated analysis of energy conversion, transmission and distribution, and resource extraction. The Transformation program provides demand-driven, engineering-based simulations, and uses a basic hierarchy

including “modules” (sectors, for example, electricity generation), each containing one or more “processes”, such as power plants or types of power plants. Each process can have one or more feedstock fuels and one or more auxiliary fuels. LEAP allows for simulation of both capacity expansion and process dispatch, and calculates imports, exports and primary resource requirements, as well as costs and environmental loadings. A schematic of a generic Transformation “Module” is shown below, but any given module can be very simple (for example, modules can have just one input and one output, and a single process and conversion efficiency, or can have multiple input and output fuels, and many different processes or plants) or very complex, depending on the data available and the modeling choices made by the user.

Generic Elements of Transformation Modules in LEAP

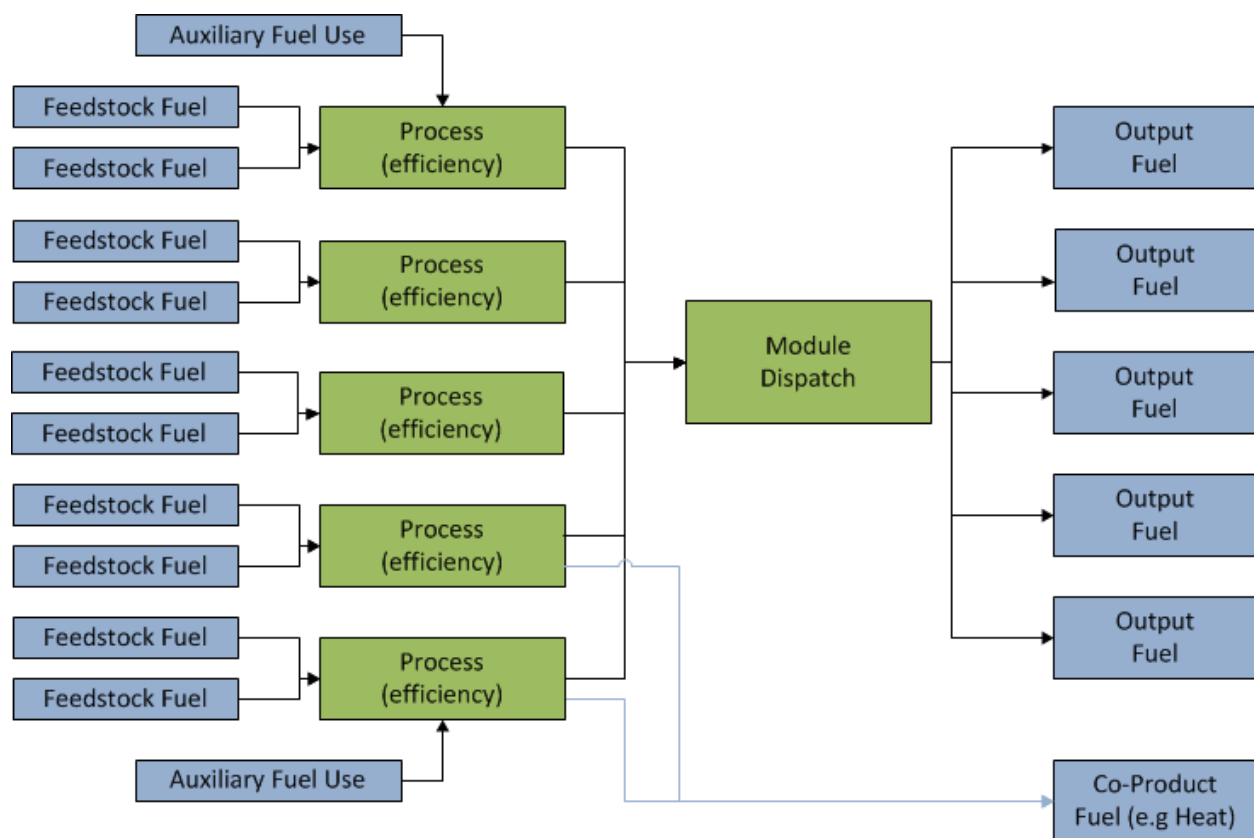

For electricity generation in particular, although LEAP is not intended to be a full-fledged dispatch model, it does provide the capability to dispatch different electricity generation resources (“processes”) using criteria ranging from running to full capacity, to dispatch by share of capacity or historical output, merit order, or least-cost resource. Plants are dispatched to meet both total demand (in MWh) as well as the instantaneous peak demand that can be defined to vary by hour, day and season. If peak demand is to be tracked, users can exogenously specify a load-duration curve and

LEAP will dispatch plants by merit order. Alternatively, load shapes be specified for each demand device so that the overall system load is calculated endogenously. Thus the effect of demand-side management (DSM) or energy efficiency policies on the overall load shape can then be explored in scenarios. Plant dispatch can also then be varied by season (for example, to reflect how hydro dispatch may vary between wet and dry seasons).

LEAP's modeling capabilities operate at two basic conceptual levels. At one level, LEAP's built-in calculations handle straightforward energy, emissions and cost-benefit accounting calculations. At the second level, users enter spreadsheet-like expressions that can be used to specify time-varying data or to create a wide variety of sophisticated multi-variable models, thus enabling econometric and simulation approaches to be embedded within LEAP's overall accounting framework. As of 2013, LEAP also supports optimization modeling: allowing for the construction of least cost models of electric system capacity expansion and dispatch, potentially under various constraints such as limits on CO₂ or local air pollution.

Time Frame

LEAP is intended as a medium to long-term modeling tool. Most of its calculations occur on an annual time-step, and the time horizon can extend for an unlimited number of years. Studies typically include both a historical period known as the *Current Accounts*, in which the model is run to test its ability to replicate known statistical data, as well as multiple forward looking scenarios. Typically, most studies use a forecast period of between 20 and 50 years. Some results are calculated with a finer level of temporal detail. For example, for electric sector calculations the year can be split into different user-defined "time slices" to represent seasons, types of days or even representative times of the day. These slices can be used to examine how loads vary within the year and how electric power plants are dispatched differently in different seasons.

Scenario Analysis

LEAP is designed around the concept of long-range scenario analysis. Scenarios are self-consistent storylines of how an energy system might evolve over time. Using LEAP, policy analysts can create and then evaluate alternative scenarios by comparing their energy requirements, their social costs and benefits and their environmental impacts. Scenarios can be used to test policy assumptions and for sensitivity analysis.

Inheritance in scenarios allows the user to create hierarchies of scenarios that inherit default expressions from their parent scenario. All scenarios inherit from a common set of Current Accounts describing energy supply and demand in one or more historical years, thereby minimizing data entry

and allowing common assumptions to be edited in one place. Multiple inheritance allows scenarios to inherit expressions from more than one parent scenario, and allows the combining of measures to create integrated scenarios. Expressions within LEAP scenarios are color coded to show which expressions have been entered explicitly in a scenario (blue), and which are inherited from a parent scenario (black) or from another region (purple).

The LEAP Scenario Manager, shown below, can be used to describe individual policy measures that can then be combined in different combinations and permutations into alternative integrated scenarios. This approach allows policy makers to assess the marginal impact of an individual policy as well as the interactions that occur when multiple policies and measures are combined. For example, the benefits of appliance efficiency standards combined with a renewable portfolio standard might be less than the sum of the benefits of the two measures considered separately. In the screen shown, individual measures are combined into an overall GHG Mitigation scenario containing various measures for reducing greenhouse gas emissions.

LEAP Scenario Manager Screen

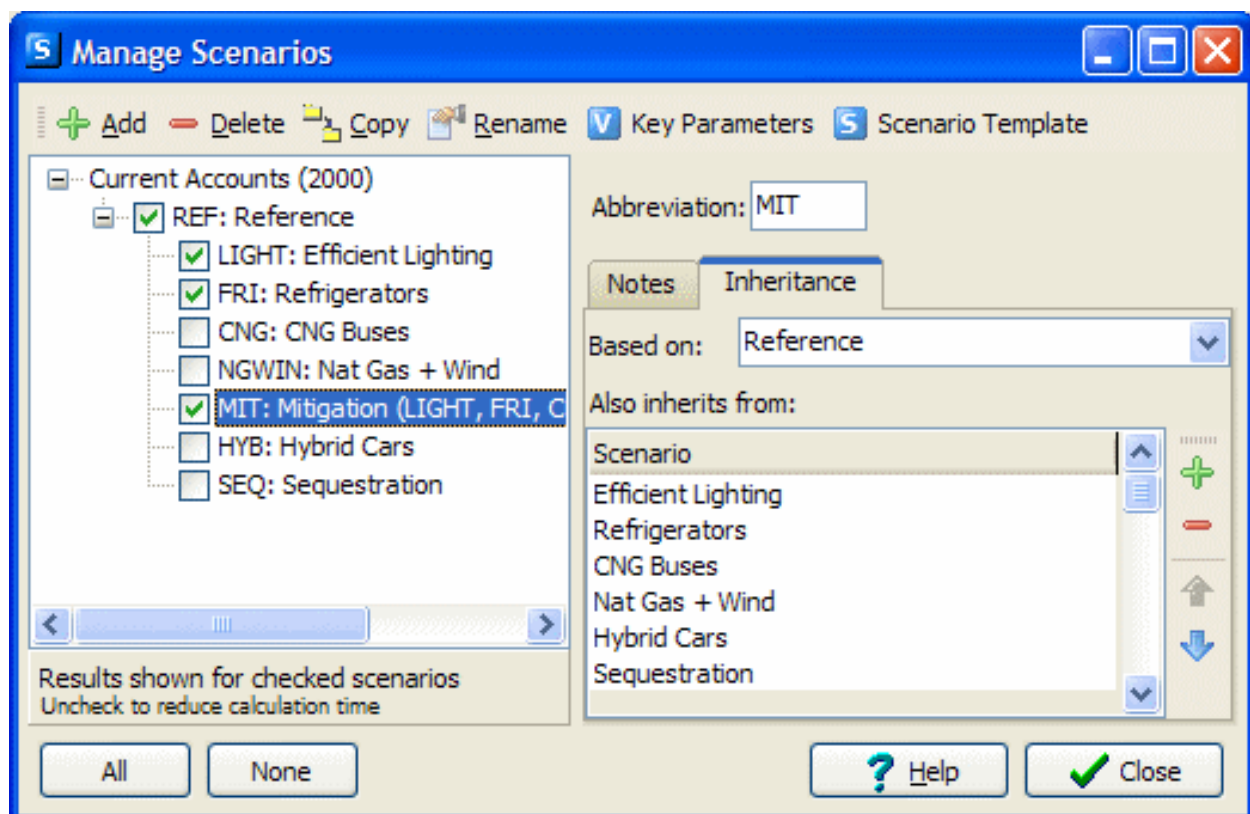

Low Initial Data Requirements

A key benefit of LEAP is its low initial data requirements. Modeling tools that rely on optimization tend to have high initial data requirements because they require that all technologies are fully defined both in terms of both their operating characteristics and their costs. They also require that the market penetration rates of those technologies have been reasonably constrained to prevent implausible knife-edge solutions. Developing the data for such models is a time-consuming task, requiring relatively high levels of expertise. By contrast, because LEAP relies on simpler accounting principles, and because many aspects of LEAP are optional, its initial data requirements are thus relatively low. Energy and environmental forecasts can be prepared before any cost data have been entered. Moreover, LEAP's adaptable and transparent data structures are well suited to an iterative analytical approach: one in which the user starts by rapidly creating an initial analysis that is as simple as possible. In later iterations the user adds complexity only where data is available and where the added detail provides further useful insights into the questions being addressed in the analysis.

Decision Support System

While methodology is an important factor in choosing an energy model, LEAP is more than just a model: it is a full decision support system (DSS) providing extensive data management and reporting capabilities. It can serve as both a historical database showing the evolution of an energy system and a forward-looking scenario-based tool that can create forecasts of how a system might evolve or “backcasts” that examine how a society might try to meet its development goals in the energy sector. LEAP provides powerful data management tools including full importing and exporting to Microsoft Excel, Word and PowerPoint, and a rich graphical environment for visualizing data and results.

Analysis View

LEAP is structured as a series of “views” of an energy system. The main “Analysis View” (shown below) is the place where users create data structures and scenarios and enter all of the data describing both historical years and forward-looking scenarios. In the Analysis View a hierarchical tree displays the main data structure for the analysis. As noted above, the tree supports standard operations (copying, pasting, dragging and dropping, etc.) that simplify the construction and maintenance of data in an energy analysis. The tree affords a great deal of flexibility in how a system is modeled. For example a demand model might be highly disaggregated in a sector where a detailed technology-based analysis is required, but much more aggregate in sectors where energy use is less important or less well-understood. LEAP also supports multi-regional analyses in which different data structures can be created for each region. For example, some countries might be described in more detail where data

are available or where important issues need to be addressed. The figure below show a “screenshot” of LEAP in the Analysis view, showing the LEAP main menu along the top of the screen, the major elements of LEAP (Analysis, Results, Balances, etc.) along the left hand side of the screen, with a tree diagram of the dataset also along the left, and an example of the an analysis data input screen in the center and right.

Screenshot of LEAP in Analysis Mode

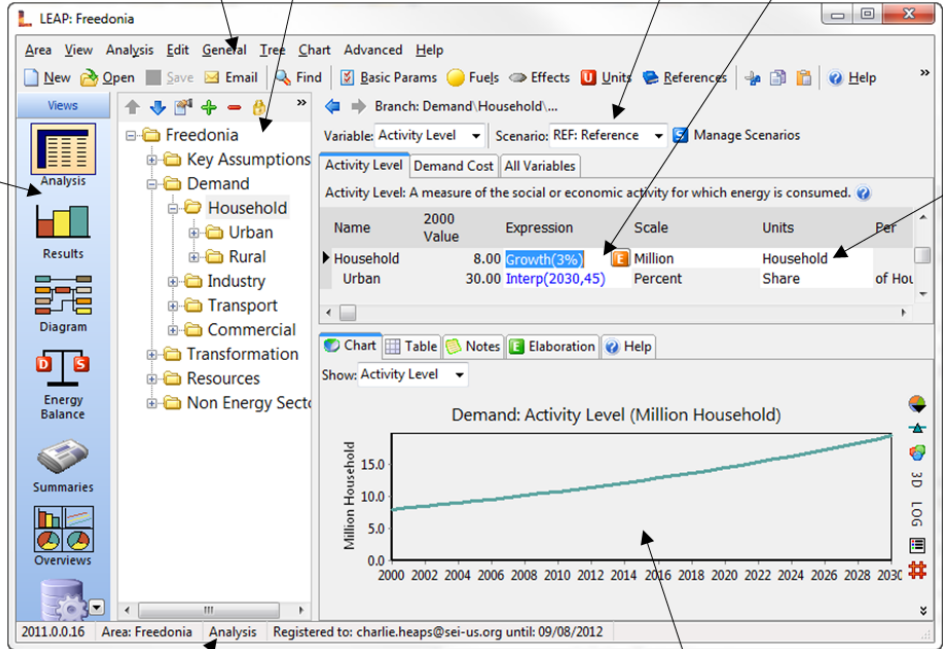

The screenshot shows the LEAP software interface in Analysis Mode. The main menu and toolbar are at the top, providing access to major options. The left sidebar contains a tree diagram of the dataset, organized in a hierarchical structure. The center and right areas display an analysis data input screen for 'Activity Level' under the 'Demand' branch. This screen includes a table for data entry and a chart for visualization. Callouts provide detailed explanations of these components.

Callouts and their descriptions:

- The main menu and toolbar give access to major options.** (Points to the top menu bar)
- Data is organized in a tree.** (Points to the left sidebar tree)
- Select scenarios here.** (Points to the 'Scenario: REF: Reference' dropdown)
- Edit data by typing here.** (Points to the 'Expression' column in the data table)
- Select units and scaling factors here.** (Points to the 'Units' and 'Scale' columns in the data table)
- Switch between views of the Area here.** (Points to the 'Views' sidebar menu)
- The status bar notes the current Area and View.** (Points to the bottom status bar)
- Data can be reviewed in chart or table format.** (Points to the chart and table view options)

Name	2000 Value	Expression	Scale	Units	Per
Household	8.00	Growth(3%)	Million	Household	of Hou
Urban	30.00	Interp(2030,45)	Percent	Share	

Tools for Creating Models

LEAP includes a number of built-in tools that make it easy to create complex models and projections. The *time-series wizard* (shown below) lets you create interpolations, step functions and various trend forecasts either by entering data directly into LEAP or by importing data or creating a link to an Excel spreadsheet.

The LEAP “Time Series Wizard” Tool for Entering Data

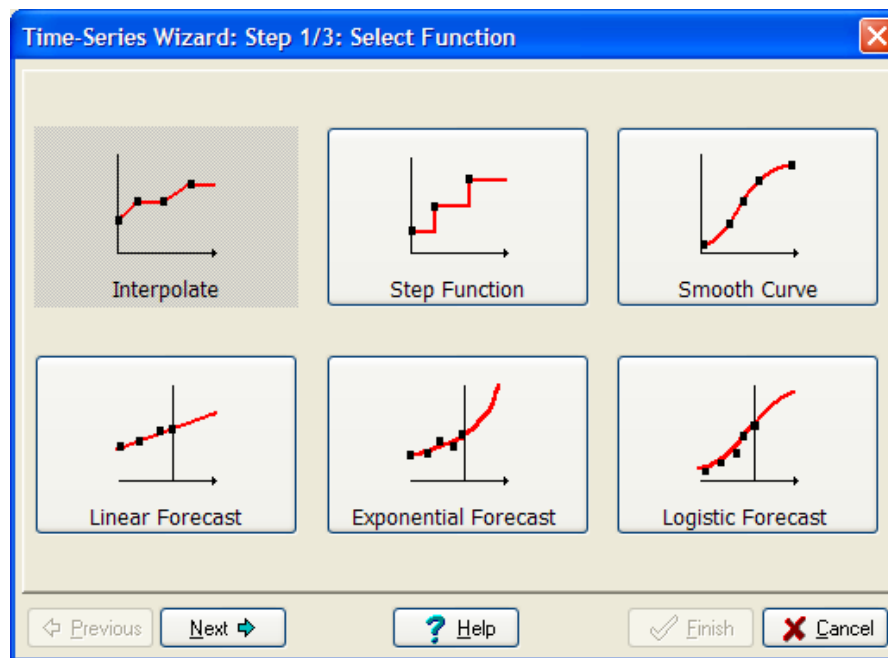

The *Expression Builder* lets you construct complex models that use LEAP’s large library of built-in functions as well as references to other data and results calculated within LEAP. Expressions are similar to expressions used in spreadsheets, and are used to specify the value of variables in many different parts of the LEAP program. Expressions can be numerical values, or a formula that yields different results in each year, can use many built-in functions, or refer to the values of other variables, can be linked to Excel spreadsheets, and can be inherited from one scenario to another. Variable references can be constructed graphically by simply dragging and dropping branches from the main tree data structure into the Expression Builder tool. To help debug these models, the Expression Builder also provides check-as-you type validation of modeling expressions, displaying any syntax or run-time error messages on a toolbar in real-time.

Results View and Overviews

Intuitive and easy-to-use reporting is another key ingredient of LEAP, helping users to visualize and interpret results and catch errors. LEAP calculates a huge set of results, which can be displayed as charts, tables and even maps. The Results View (shown below) makes working with multi-dimensional results very easy. For example, energy demand results are calculated across five dimensions: fuels, years, scenarios regions, and branches (i.e. the sectors and subsectors of the analysis). The user simply chooses the dimensions to display on each axis of the chart. For the other dimensions, the user can choose to display results for just one element or to sum results across all or

selected elements. For example, the user might select demand results by fuel and by year for a particular region and a particular scenario for one sector (e.g. households).

LEAP Results Screen Showing an Example of Energy Demand Outputs

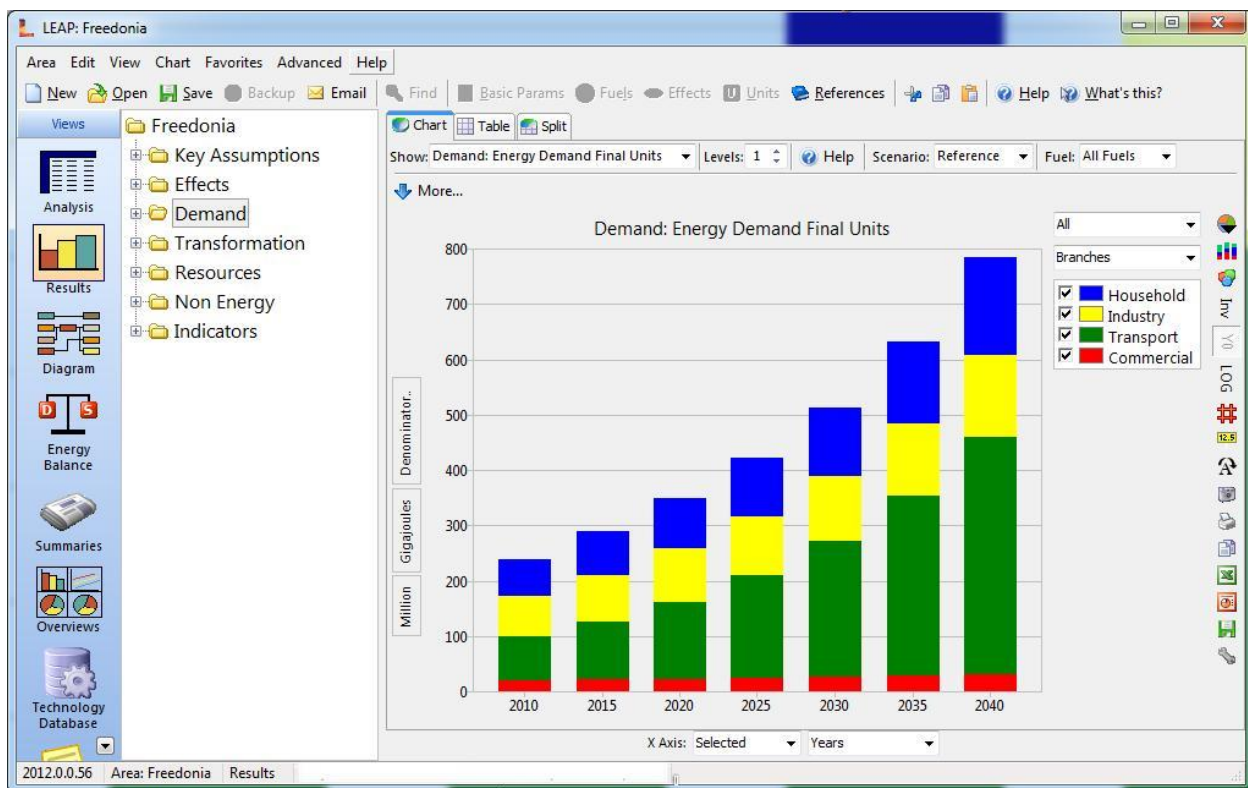

Results can be displayed in almost any unit of measurement and numerous options are available for configuring results, including choice of type of chart (area, bar, line, pie, etc.), chart color, numeric format (absolute values, growth rates, percentage shares), number of decimals displayed in tables, etc). Alternative policy scenarios can be compared and evaluated by plotting multiple scenarios or by showing the differences in results versus a selected scenario. For example, you might compare costs for an active policy scenario versus a policy neutral business-as-usual scenario. All results can also be exported with a single mouse click: tables to Excel and charts to PowerPoint.

You can configure and save “favorite” charts in much the same way as you store bookmarks in a web browser: making it easy to quickly switch between key results for an analysis. Multiple favorite charts can even be grouped together and plotted on screen in the Overview view (shown below). Because results can easily and quickly be recalculated, LEAP can be used as a highly interactive debugging tool: one that encourages users to think critically about the validity and plausibility of analyses. LEAP’s training materials further reinforce the importance of these techniques.

Energy Balance View

LEAP also includes a series of specialized reports including standard energy balance reports and energy flow diagrams. An energy balance is an accounting system that describes the flows of energy through an economy during a given period. The name “balance” refers to the fact that the quantities of primary energy produced must be equal to the quantities consumed, after accounting for changes in stocks, imports and exports and the share used for conversion into secondary energy carriers, including losses. The energy balance report (shown below) closely follows the standard format employed by the IEA and most national energy planning agencies. LEAP’s energy balances can be displayed in table, chart and flow diagram format and they can be customized to summarize information for detailed or simplified fuel categories, for different years or for different regions. Balance results can also be shown by sector or by subsector in any energy unit.

Example of a LEAP Energy Balance Table

Energy Balance for: Freedonia								
Scenario: Reference. Year: 2000 (Million Gigajoule)								
	Solid Fuels	Natural Gas	Crude Oil	Hydropower	Biomass	Electricity	Oil Products	Total
Production	125	0	0	20	81	0	0	226
Imports	0	4	185	0	0	0	0	189
Exports	0	0	0	0	0	0	0	0
From Stock Change	0	0	0	0	0	0	0	0
Total Primary Supply	125	4	185	20	81	0	0	415
Coal Mining	-25	0	0	0	0	0	0	-25
Oil Refining	0	0	-185	0	0	0	176	-9
Charcoal Making	0	0	0	0	-32	0	0	-32
Electricity Generation	-86	0	0	-20	0	58	-51	-98
Transmission and Distribution	0	0	0	0	0	-9	0	-9
Total Transformation	-110	0	-185	-20	-32	50	125	-174
Statistical Differences	0	0	0	0	0	0	0	0
Household	0	3	0	0	33	18	13	68
Industry	14	0	0	0	16	20	22	72
Transport	0	0	0	0	0	1	78	79
Commercial	0	0	0	0	0	10	10	20
Total Demand	14	3	0	0	49	50	123	239
Unmet Demand	0	0	0	0	0	0	-2	-2

TED: The Technology and Environmental Database

Analysts often need ready access to comprehensive and up-to-date data describing energy technologies. Such data are spread across a range of sources, which are not easily accessible, particularly to analysts in the developing countries. To address this problem, LEAP includes a

Technology and Environmental Database (TED) that describes the technical characteristics, costs and environmental impacts of a range of energy technologies including existing technologies, current best practices and next generation devices.

TED includes data on hundreds of technologies, referencing reports by dozens of institutions including the Intergovernmental Panel on Climate Change (IPCC), the U.S. Department of Energy, and the International Energy Agency. In addition to its quantitative data, TED also includes qualitative information pages that review the availability, appropriateness, cost-effectiveness and key environmental issues for a wide range of energy technologies. TED's own core database of emission factors can be edited or supplemented by a user's own data. Emission factors and other information from TED, including a full suite of IPCC Tier 1 and Tier 2 emission factors across a wide range of energy-using devices, can be automatically incorporated into LEAP analyses, making it easy to create emissions scenarios based on LEAP's energy scenarios and the emission factors in TED. A schematic of data organization within TED is shown below.

Structure of TED: The Technology and Environmental Database

Fields →

	Information Pages	Technology Data	Cost Data	Environmental Impacts	Notes Reference
Technologies					
Demand					
Conversion		Database Contents			
Supply: Extraction					
Transmission & Distribution					

The Notes View

However well-designed an analysis, its usefulness will depend on how well it is documented and referenced. The Notes View in LEAP helps to address this problem, by providing a simple word processing tool with built-in bibliographic references database. The Notes view encourages users to document their data, assumptions and methods, both for their own use and for the use of colleagues or other reviewers looking at the dataset. Notes can be entered at each branch of the tree data structure, and subsequently printed or exported to Microsoft Word for use in reports.

National Starter Data

The SEI Energy Modeling team has created a set of national level "starter" data sets for LEAP. These data sets compile international data together in a consistent manner as a starting point from which developing country analysts can subsequently develop their own more detailed analyses. They are designed to combine historical energy balance data provided by the IEA (International Energy Agency) with various other data sources such as emission factors from the IPCC (Intergovernmental Panel on Climate Change), population projections from the United Nations, development indicators from the World Bank, non-energy sector GHG sources and sinks from the World Resources Institute and energy resource data from the World Energy Council. More information on starter datasets is available at <http://www.energycommunity.org/default.asp?action=153>.

Internationalization

LEAP and its associated training materials are already available in English, French, Spanish, Portuguese and Chinese with many additional translations currently under development by volunteers. A menu option within LEAP lets you immediately switch between any of its available language translations. LEAP also allows data to be input and to be displayed in any regional numeric format.

Recent New Features and Advanced Modeling Capabilities in LEAP

Among some of the recent (2012-2013) additions to the capabilities of the LEAP system are:

- Modeling of the energy-water nexus through links to SEI's "WEAP" water model for integrated energy/water assessment.
- The availability of flexible region and fuel groupings (used in new global mode). For example, SEI's new global energy model, built in LEAP, modeled 22 global regions, while results were presented aggregated across 22, 10, 6 and 3 macro regions.
- Improved ease-of-use (many screens redesigned and simplified).
- New demand modeling methods.

- More options for formatting charts that can be exported in high resolution for direct use in reports.
- Improved optimization calculations, including support for specification of a Renewable Portfolio Standard, and ability to specify maximum and minimum capacity constraints and annual addition constraints.
- Better treatment of externality costs.
- An improved Manage Areas screen: better tools for managing data sets.
- LEAP now allows up to 400 user-defined variables (up from 30). The visibility of these can be set so they appear only at certain branches and in certain scenarios. They can also be color coded and have default expressions set for Current Accounts and Scenarios.
- Better support for previously committed (residual) capacity.
- Now supports Mixed Integer Linear Programming to accurately simulate discrete capacity additions.
- Supports 64 bit version of GLPK – faster and less prone to out-of-memory errors
- Supports 20, 100 and 500 Year GWP (global warming potential) factors, and includes a library of GWP factors from all four IPCC assessment reports.

In addition to its use as a stand-alone modeling system, LEAP can also be integrated into a larger network of models using its standard Application Programming Interface (API). The API allows LEAP to be controlled using any standard object-oriented programming language, such as Visual Basic, C or Java. Programs can control how LEAP runs, insert and edit data, extract results or even programmatically alter data structures in LEAP. LEAP even includes its own built-in scripting tool, which you can use to create Visual Basic scripts that control LEAP.

Indicators

In addition to its modeling capabilities, LEAP can now also be used as a tool for calculating, evaluating and displaying many social, economic, and energy-related development indicators. A range of functions are available that make it easy to create composite normalized indicators that compare results across regions or that evaluate the performance of alternative scenarios. A wide variety of indicators can be generated including 5 and 10 star scores, rankings and z-scores.

Hardware and Software Requirements

LEAP is a single-user system that operates on any PC using Windows 2000, XP, Vista, Windows 7 or Windows 8. It requires a 400 MHz or better CPU with a minimum of 128 MB of RAM. An Internet connection is not required but is useful for online access to updates, technical support and additional

data sets. Similarly, LEAP is designed to work closely with Microsoft Office applications although these are not required. Additional experimental information about using LEAP within the WINE environment, which allows it to operate also on Linux and Apple computers, is available at <http://www.energycommunity.org/default.asp?action=183>.

Documentation and Help

LEAP includes extensive documentation and context-sensitive help. The help system, which contains over 300 pages of help, can be accessed from anywhere in the program using standard help keys or a point-and-click “What’s this?” help system. In addition, succinct “balloon help” messages are available for all on-screen elements (buttons, menu options and all variables). LEAP even includes a tip-of-the-day feature, which helps users to deepen their knowledge as they use LEAP.

Training and Capacity Building

LEAP is one of a very few integrated energy-environmental planning tools that have been consistently updated, used, and supported over many decades. From its origin in the late 1970s and early 1980s as a mainframe tool for the Beijer Institute's Kenya Fuelwood Project, through its development as a tool for personal computers starting in 1985 and its first Windows-based edition in the early 2000s, LEAP's continued development has drawn financial support from international organizations, and national aid agencies in recognition of its global utility as a planning tool and a focus for capacity-building. LEAP's design as a comprehensive decision support system, has allowed it to develop a reputation among its users for presenting complex energy analysis concepts in a transparent and intuitive way. "LEAP is the only substantial energy modeling software that is reasonably accessible to energy consultants who are not modeling specialists," says Mark Borchers, Director of Sustainable Energy Africa.

For over twenty years LEAP has been an important tool in the training and capacity building programmes of many national and international institutions in all major regions of the world. SEI has created a range of training materials designed to support these efforts. These have been translated into various languages and have been applied by SEI and its partners in a huge number of seminars and training workshops worldwide. The training materials are designed to draw out typical energy-environment policy dilemmas, and to encourage trainees to think about the tradeoffs inherent in different policy options.

Information Resources

COMMEND, the Community for Energy Environment and Development (www.energycommunity.org), is a web-based initiative designed to foster a community among developing country energy planners and to provide support to users of LEAP and other energy modeling tools. The site is open to all at no charge. COMMEND includes discussion forums (<http://www.energycommunity.org/default.asp?action=48>) where users can receive LEAP technical support from SEI and other expert LEAP users. The site also has links to reference materials including descriptions of LEAP applications, (<http://www.energycommunity.org/default.asp?action=45>), an online library of useful data sources and guidebooks for energy analysis, which also provides access to energy and related studies done with LEAP and other tools, is available at <http://www.energycommunity.org/default.asp?action=73>, and a publications database is available at <http://www.energycommunity.org/default.asp?action=172>. The COMMEND website provides a variety of different resources designed to aid the user in energy and environmental modeling projects. A listing of many of the different models available is provided as <http://www.energycommunity.org/default.asp?action=71>. . A listing of courses offered around the world courses that may be of interest to those studying energy, environment and sustainability issues is provided as <http://www.energycommunity.org/default.asp?action=81>. The reader is urged to access the COMMEND website for additional information.

Dissemination

LEAP and all of its associated training materials and documentation are distributed free of charge to academic, governmental and not-for-profit organizations based in the developing world. These training materials ([see http://www.energycommunity.org/default.asp?action=42](http://www.energycommunity.org/default.asp?action=42)) and user guides (<http://www.energycommunity.org/default.asp?action=41>) are available for download at the COMMEND website along with information on licensing (<http://www.energycommunity.org/default.asp?action=43>) arrangements for other types of organizations. A user name and password are required to fully enable LEAP. These are made available on completion of a license agreement, which all users are expected to sign.

Technical Support

In addition to the included help files and other materials, LEAP offers features allowing users to send LEAP datasets to SEI-US and to others as desired for review and help. In addition, as noted above, the COMMEND website includes discussion forums where users can receive LEAP technical support from SEI and other expert LEAP users. Support for LEAP is also available from SEI via email at leap@sei-us.org.

While LEAP is designed to be as user-friendly as possible and is, we believe, significantly easier to use than other energy modeling tools, nevertheless it remains a relatively complex tool. Most users will typically need training for about one week before they can use it effectively. Training is available through SEI and its regional partner organizations. We do organize regular LEAP training workshops in various regions of the world (see <http://www.energycommunity.org/default.asp?action=104>). Please check the COMMEND web site for news of these. Alternatively, please contact SEI (leap@sei-us.org) to request a quotation for a training workshop for a particular country or organization.

Citing LEAP

Guidelines on how to properly cite LEAP in published research are available at <http://www.energycommunity.org/default.asp?action=171>.

LEAP Team Contacts

For more information about LEAP or COMMEND, please contact:

The COMMEND Team

Stockholm Environment Institute - US Center

11 Curtis Avenue, Somerville, MA 02144, USA

Email: leap@sei-us.org

Web: www.sei-us.org

Phone: +1 (617) 627-3786

